

BJ-W3000 Wireless Temperature monitor

User Manual

Version: 1.4

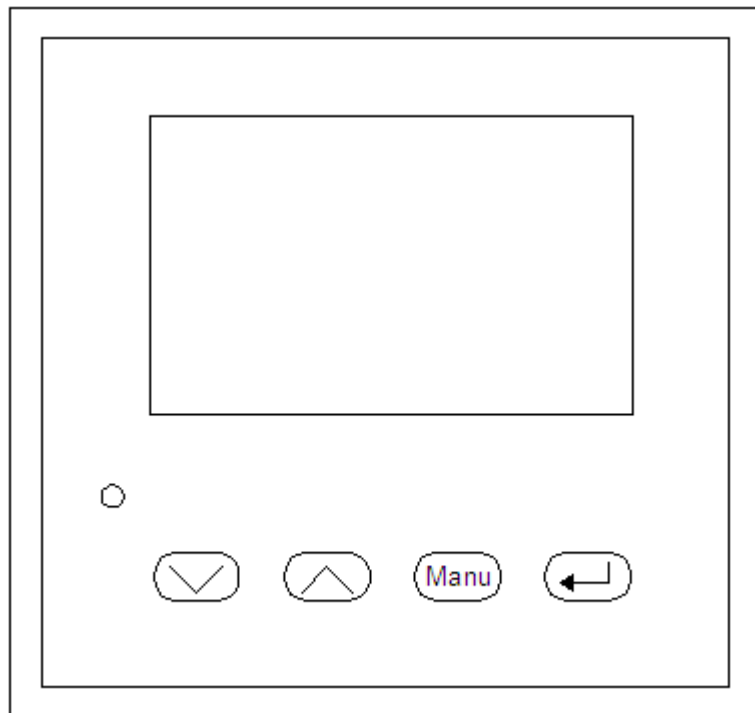

Read me

When you use BJ-W series Wireless Temperature Monitor, be sure to carefully read this user manual, and be able to fully understand the implications, the correct guidance of operations in accordance with user manual, which will help you make better use BJ-W series Wireless Temperature Monitor, and help to solve the various problems at the scene.

1. Before the meter turning on the power supply, be sure that the power supply within the provisions of the instrument;
2. When installation, the current input terminal must non-open, voltage input terminals must Non-short circuit;
3. Communication terminal (RS485) is strictly prohibited to impose high pressure;
4. Be sure the instrument wiring consistent with the internal system settings;
5. When communicating with the PC, instrument communication parameters must be consistent with the PC



- **Please read carefully before using this user manual**
- **Please save this document**

Directory

CONTENTS	Page
1. SUMMARIZE -----	1
2. APPLICATIONS -----	1
3. FEATURES -----	2
3.1. -Base monitoring unit-----	2
3.2. - Data receiver unit-----	2
3.3. - Wireless remote sensing unit: -----	2
3.4. - Monitor software (optional) -----	2
3.5. -Specifications -----	3
4. INSTALLATION AND START-UP-----	4
4.1.- Installation-----	4
4.2. - Connection terminal (see label on the rear part) -----	5
4.3. - Connection drawing for the BJ-W-----	6
5. SCREEN DISPLAY-----	7
5.1. - Panel diagram-----	7
5.2. - Display summary-----	7
6. OPERATION MODE-----	8
7. MENU INTRODUCTION-----	9
7.1- Setting -----	9
7.1-1.-set the local time-----	9
7.1-2. -set the alarm output value-----	10
7.1-3. -communication setting-----	10
7.1-4. -communication setting-----	10
7.2. - Alarm event review-----	11
8. COMMUNICATION INTERFACE -----	12
8.1- Connection for the RS485 BUS -----	12
8.2- MODBUS © protocol -----	13
8.3- Register address table -----	14
9. SAFETY CONSIDERATIONS-----	15
10. MAINTENANCE-----	15
11. TECHNICAL SERVICE-----	15

1.- SUMMARIZE

The Blue Jay Electronic monitor measures and transmits the temperature and humidity data via wireless technology, solutions offering economic and flexible systems for every temperature and humidity measurement requirement. The wireless sensing units can be installed anywhere within radius from the local base receiver unit.

Adding on additional sensing units is easy; use multiple receivers, the units work together to keep you on top of the environmental conditions within your space. In case of over-temperature or under-temperature conditions, the alarm sounds with a warning light indicator to notify you of the abnormal condition.

2.- APPLICATIONS

The food industry - production, processing, catering and retail

The pharmaceutical industry - manufacture, storage and distribution

Laboratories - fridges, freezers, cold rooms and incubators

Cold storage and warehousing

Transport

Building management

Environmental monitoring

Horticulture

Animal husbandry

3.- FEATURES

3.1.- Base Monitoring Unit:

Process the transmitted data from the data receiver units, displays the current values, and alarm status. Pre-defined high or low temperature conditions trigger the red alarm indicators and the alarm sounds to notify you of the situation in real-time.

3.2.- Data receiver unit:

Receive the data form wireless sensing unit, and transmit via RS485 to base monitor unit, each receiver and connect 12 wireless monitor points, use multiple data receivers can monitor temperature in a particular space or device.

3.3.- Wireless Remote Sensing Unit:

Measures the temperature and humidity value and transmits the data wirelessly to the local receiver unit and operates with button batteries (included), which can be installed and replaced very easily by the end user. Battery life is 3-5 year*.

3.4.- Monitor Software*: (Optional)

Log temperature & humidity data on your PC and produce the reports to you. Reports include: Temperature curve, Data record, Real-time data, Alarm setting

Notes:

1. Battery life depends on the working condition and user settings with the detection interval
2. Monitor Software can design by customer requirement, please contact to the Technical Support of Blue Jay Electronic Co., Ltd. (tech@cqbluejay.com)

OTHER FEATURES

- Low-size (144 x 144 mm), panel-mounting base unit.
- Instantaneous, maximum and minimum values of each measured parameter.
- Alarm output (indication through a lighting led)
- RS-485 or Ethernet communication to a PC (optional)

3.5.- SPECIFICATIONS

1.- Power Supply:

AC / DC 80-270V, 45-65Hz
DC 20-60V (Optional)
Maximum power consumption 6W

2.- Wireless Remote Sensing Unit

Standard type 3-12*

3.- Temperature monitor range

From 0°C ~ 99 °C

4.- Wireless communication frequency

315MHZ or 433MHZ

5.- Transmit power

Less than 10mW

6.- Distance of the receiver and monitor

Up to 80m (260 foot)

7.- Battery life

3-5 years (Every fifteen minutes to send a data)

8.- Work environment

Temperature: -20°C ~ +125°C
Humidity: RH 20% ~ 95% (No condensation)

9.- Protection

Panel: IP40

10.- Storage Conditions

Temperature: -25°C ~ +60°C
Humidity: RH 20% ~ 95%

12.- Dimensions (L × W × H)

Base Monitoring Unit	144mm×144mm×110mm
Data receiver unit	65mm×50mm×30mm
Wireless Remote Sensing Unit	65mm×50mm×25mm

4.- INSTALLATION AND START-UP



The manual you hold in your hands contains information and warnings that the user should respect in order to guarantee a proper operation of all the instrument functions and keep its safety conditions. The instrument must not be powered and used until its definitive assembly on the cabinet's door.

Whether the instrument is not used as manufacturer's specifications, the protection of the instrument can be damaged.

When any protection failure is suspected to exist (for example, it presents external visible damages), the instrument must be immediately powered off. In this case contact a qualified service representative.

4.1.- Installation

Mounting

Instrument is to be mounted on panel (cut-out $136.5+0.8 \times 136.5+0.8 \text{ mm}$). All connections keep inside the cabinet.

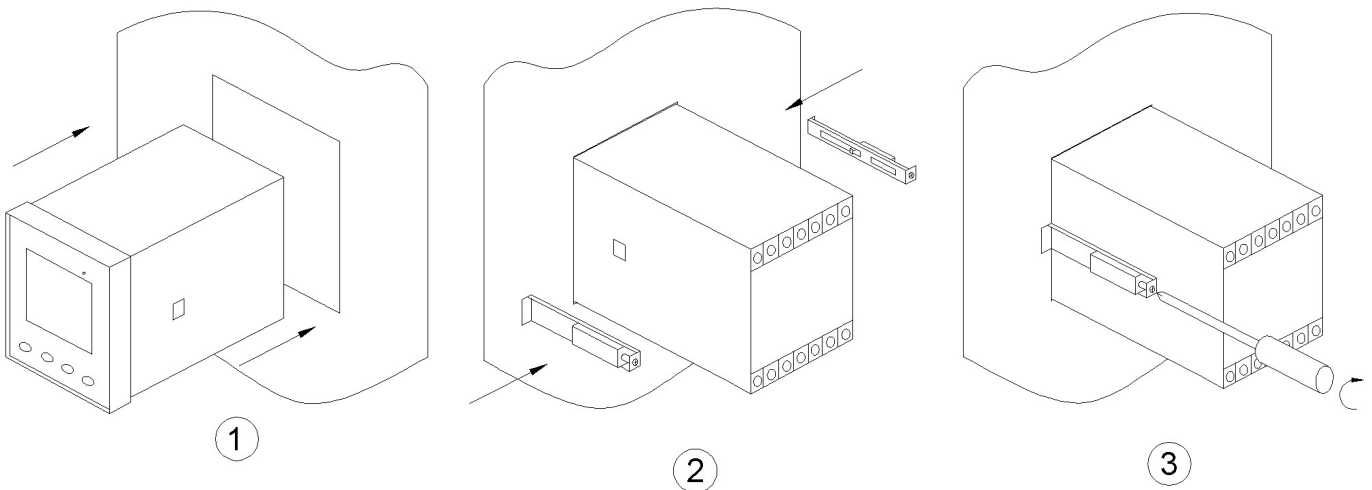

Note that with the instrument powered on, the terminals could be dangerous to touching and cover opening actions or elements removal may allow accessing dangerous parts. Therefore, the instrument must not be used until this is completely installed.

Auxiliary power:

BJ-W Series Wireless Temperature Monitor with universal (AC / DC) power input, if not for a special statement, we provide the 220VAC/DC or 110VAC/DC power interface for standard products Instruments limit work power supply : AC / DC :80-270V, please ensure that the auxiliary power can match for BJ-W Series Wireless Temperature Monitor to prevent damage to the product.

- A. Suggest install 1A fuse in the fire line side.
- B. For the areas with poor power quality, suggest install lightning surge suppressor and rapid burst suppressor to prevent lightning strikes

4.2.- Connection terminal (see label on the rear part)

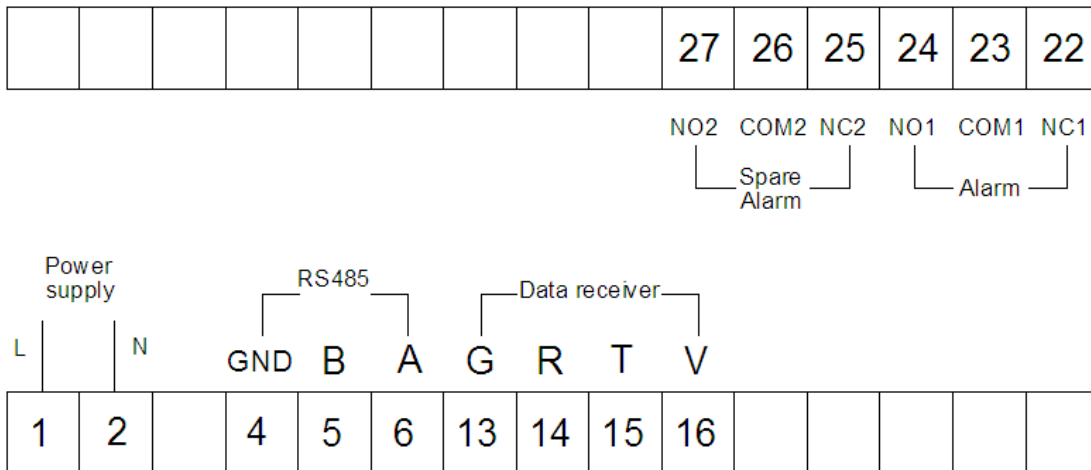

Terminal description

Upper connection terminal

- 22 (NC) Normal close pin
- 23 (COM) Ground pin
- 24 (NO) Normal open pin
- 25, 26, 27 for Spare alarm output

Lower connection terminal

- 1. *Supply voltage input:220 Va.c.
- 2. *Supply voltage input: 0 V
- 4. RS-485 (GND)
- 5. RS-485 (-)
- 6. RS-485 (+)
- 13(G) 14(R) 15(T) 16(V).connect to data receiver unit corresponding pin

4.3.- Connection drawing for the BJ-W

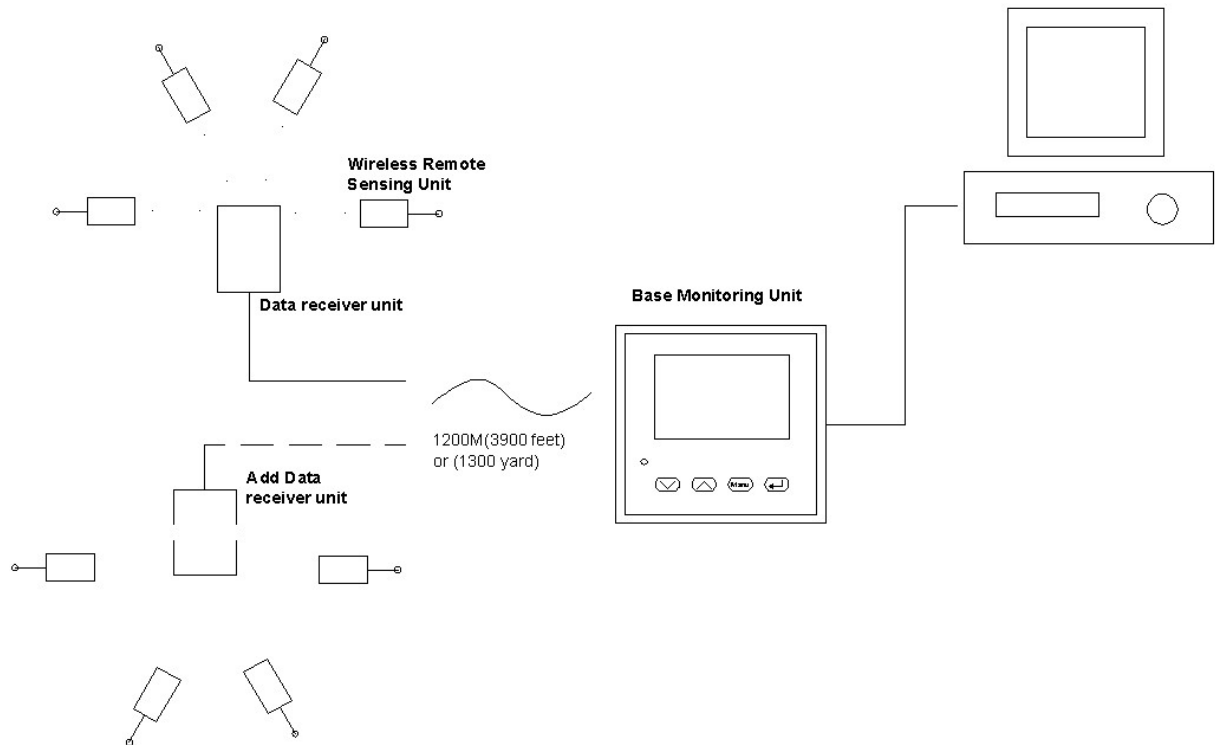

Sensor fixed with close to the measured surface

For environmental measurement type, use should set the sensor case and data sensing unit in a suitable place

Note: If any special requirement for the test environment, or objects, please contact Blue Jay Technical Support for further details

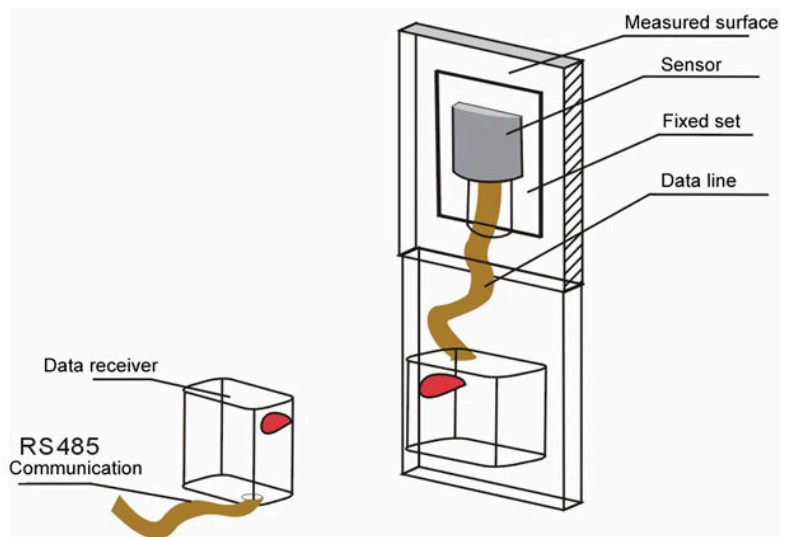

IMPORTANT REMARK!

If no display on the Base Unit or temperature data is abnormal, please check out following points:

- R485 wiring is correct?
- Sensor is correctly placed in the measured surface?

5. Screen display

5.1.- Panel diagram;

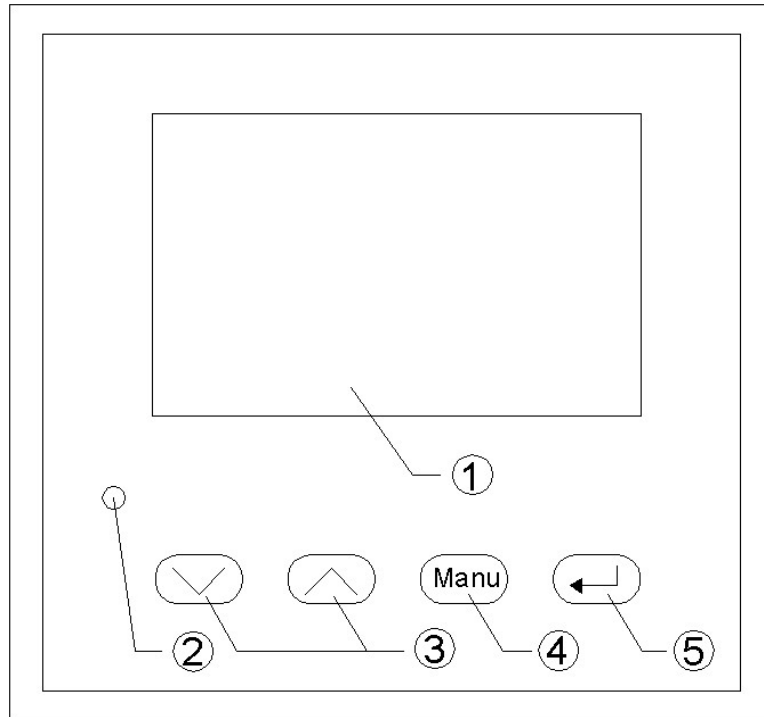

5.2.- Display Summary

No.	Display	Explanation
1	3.3 inch matrix LCD	Show the temperature or humidity data, Can be customized to different languages
2	Indicator of alarm output	Red LED show the alarm condition, alarm value can be programmable setting
3*	Up and Down key	Set the programming value
4*	Menu key	Used to open the menu and return to previous menu
5*	Enter key	For menu selection and confirmation

Note: Please see detail instructions of “*” items at “**OPERATION MODE**”

6.- OPERATION MODE

Blue Jay Electronic

0086-023-67636974

When the power up, the monitor will shows the **Welcome screen**, so informing about the manufacturer and the Technical servers TEL.(Accept customized info)



CHANNEL 1=25.3 °C

CHANNEL 2=25.8 °C

CHANNEL 3=26.1 °C

13-06-25 12:22

After 2 second, the monitor unit will in to monitor display, show the page 1 sensor data, current time, month, and year. User can press

 and  key to switch the data page

Notes:

1. If disconnection between the receiver module and the base unit, the display will show "**Broken**".
2. If abnormal caused by the temperature transmitter module fault, the display will show "**Error**".
3. If abnormal caused by a broken of thermocouple, the display will show "**V broken**".
4. If Transmitter battery have low-voltage, the display will show "**Under voltage**", in this cause user should replace the batteries immediately

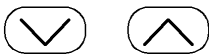

User can use up or down key to switch the display show,

At programming display mode, press  and  to increase or decrease the value,



Pressing the "Manu" key the can open the programming menu and return to previous menu



Pressing the "Enter" key ,you exit it with saving any modification that you might have done, in menu operation press "Enter" key ,user can go to the next menu

7.- MENU INTRODUCTION

The MENU in BJ-W3000 is performed by several set options.

Once into the MENU, use the keyboard to select different options and enter required variables:

→ Configuration
SOE
HELP

Configuration: free to set system parameter

SOE: Alarm event, can record last 10 list info

HELP: help info (accept customized info)

7.1.- Setting

In this section, user will set:

1. Time setting
2. Alarm setting
3. COMM setting
4. Note setting

7.1.1.- Set the local time

In setting mode, press key "⏪", the monitor will show:

→ Time setting
Alarm setting
COMM setting
Note setting

Then press "⏪" again, the monitor will show:

2013-06--23
15:30

[OK]

Use key ⏴ and ⏵ to set the value, and press (Manu) to move the cursor to set the next parameter, after set, press ⏪ to save and escape the local time setting

7.1.2.- Set the alarm trig value

The base monitor unit have two relay output for alarm, the connect pin for relay please refer to **chart 4.2**.

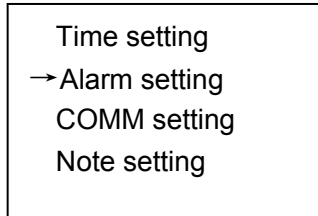

In setting menu, choose this item, and press  to enter the alarm setting.

The monitor will show:

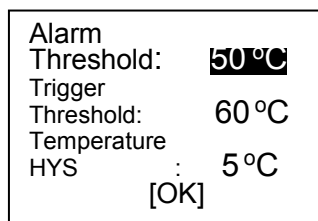

Monitor can set two alarm output values:

Alarm threshold temperature: for notes onsite person the temperature change

Trigger threshold temperature: can connect breaker or other Actuator to forced shutdown circuit, prevent over-temperature damage

Note: Trigger threshold value should be higher than alarm threshold value

After set, press  to save and escape the local time setting

7.1.3.- COMM setting

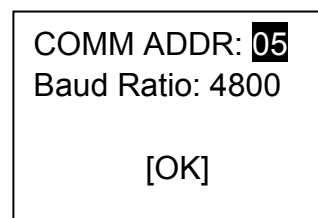

Base monitor unit can be connected to a P.C. With this system we can get all the parameters in one central point of reading. It has a serial RS-485 port. If we connect more than one device to the same communication line (RS-485), we have to assign to each of them a different code or direction (from 1 to 247), since the P.C. needs the identification of every measuring point.

Line one means the **Communication address**, the set value from 1~247

Line two means the **“BAUD”**, the set value from 4800~38400

7.1.4.- Communication setting

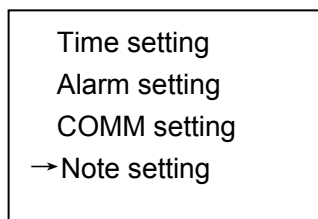



BJ-W Allows customers to define the name of each probe point. (Default is disabled, accept customized info)

7.2.- Alarm event review

The base monitor unit can record the alarm event, user can easily view the over-temperature conditions on the unit, without other device

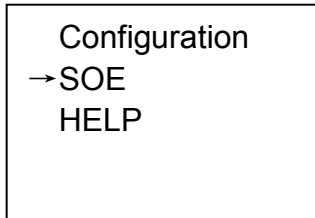
In the setting menu, press  and  to choose alarm event, the screen will show:



Press  the screen show:

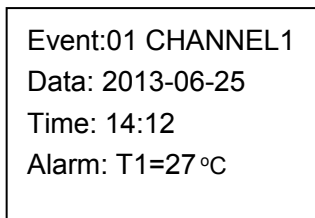

If the monitor detects an over-temperature, it will record the alarm type, data, time, and temperature, the memory standard is 10 items, need more record capacity, please contact Blue Jay Electronic sales team

8.- COMMUNICATION INTERFACE

8.1.- Connection for the RS485 BUS

The composition of the RS-485 cabling must be carried out with a meshed screen cable (minimum 3 wire), diameter of not less than 0.5mm², with a maximum distance of 1,200 m between the BJ... and the master unit. This Bus may connect a maximum of 32 BJ194...

Note:

1. For communication with the master unit, customers can choose the RS-232 to RS-485 converter to use
2. Full range of BJ meter RS485 PIN number is 58,59,60
3. Due to product modifications or custom requirements, the interface pin place may be change. For details, please refer to product label on the rear board

8.2.- MODBUS © protocol

Modbus RTU Frame Format:

Address code	1 BYTE	<i>Slave device address 1-247</i>
Function code	1 BYTE	<i>Indicates the function codes like read coils / inputs</i>
Data code	4 BYTE	<i>Starting address, high byte Starting address, low byte Number of registers, high byte Number of registers, low byte</i>
Error Check code	2 BYTE	<i>Cyclical Redundancy Check (CRC)</i>

:

MODBUS FUNCTIONS

Code:	Meaning:	Description:
FUNCTION 03	Reading of n Words	<i>This function permits to read all the electrical parameters of the BJ194...series.</i>
FUNCTION 16	Preset Multiple Registers	<i>Write value in to the relevant register</i>

Notes: Blue Jay Default disable the write function, if want change configuration via RS485, please contact Blue Jay Sales Team before your order.

8.3. - Register address table

Host send	Byte	example	
Slave address	1	01	send to slave "01"
Function code	1	03	read register
Start register	2	00 00	start address 0000
Data length	2	00 04	read 2 register
CRC code	2	44 0c	CRC code
Slave response	Byte	example	
Slave address	1	01	data from slave "01"
Function code	1	03	read register
Data length	2	07	7 bytes data followed
register 0	2	00	channel 1 temperature data
register 1	2	00	channel 2 temperature data
register 2	2	00	channel 3 temperature data
register 3	2	00	channel 4 temperature data
register 4	2	00	channel 5 temperature data
register 5	2	00	channel 6 temperature data
register 6	2	00	channel 7 temperature data
register 7	2	00	channel 8 temperature data
register 8	2	00	channel 9 temperature data
register 9	2	00	environment temperature data
CRC code	2	00 32	CRC code

9.- SAFETY CONSIDERATIONS



All installation specification described at the previous chapters named:
INSTALLATION AND STARTUP, INSTALLATION MODES and PECIFICATIONS.

Note that with the instrument powered on, the terminals could be dangerous to touching and cover opening actions or elements removal may allow accessing dangerous parts. This instrument is factory-shipped at proper operation condition.

10.- MAINTENANCE

The product does not require any special maintenance. No adjustment, maintenance or repairing action should be done when the instrument open and powered on, should those actions are essential, high-qualified operators must perform them.

Before any adjustment, replacement, maintenance or repairing operation is carried out, the instrument must be disconnected from any power supply source.

When any protection failure is suspected to exist, the instrument must be immediately put out of service. The instrument's design allow a quick replacement in case of any failure.

11.- TECHNICAL SERVICE

For any inquiry about the instrument performance or whether any failure happens, contact to Blue Jay's technical service.

Blue Jay - After-sales service

*Building 13, 2-8, Jialing third village Pioneer Park,
Jiangbei District , 400020 Chongqing*

Tel - + 0086 023 67628702

E-mail : tech@cqbluejay.com