

APM-96Q Multi-Function Power Meter

User Manual



Version: 1.14

Revision: 2026.04

Read me

When you use APM-96Q multi-function power meter, be sure to read this user manual carefully, and be able to fully understand the implications, the correct guidance of operations in accordance with user manual, which will help you make better use of APM-96Q multi-function power meter and help to solve various problems at the scene.

1. Before the meter turn on the power supply, be sure that the power supply within the provisions of the instrument;
2. When installation, the current input terminal must be non-open, voltage input terminals must be non-short circuit;
3. Communication terminal (RS232/RS485) is strictly prohibited to impose on high pressure;
4. Be sure the instrument wiring is consistent with the internal system settings;
5. When communicating with the PC, instrument communication parameters must be consistent with the PC.



- **Please read this user manual carefully**
- **Please save this document**

Directory

1.- SUMMARIZE	- 1 -
2.- FEATURES	- 3 -
2.1.- ELECTRICITY METERING	- 3 -
2.2.- TECHNICAL PARAMETERS	- 4 -
3.- INSTALLATION AND START-UP	- 6 -
3.1.- INSTALLATION	- 6 -
3.2.- CONNECTION TERMINAL	- 9 -
3.3.- TYPICAL WIRING	- 11 -
4.- OPERATION MODE	- 12 -
5.- SCREEN DISPLAY	- 13 -
5.1.- OVERALL MENU SCREEN	- 13 -
6.- DETAIL PARAMETER SCREEN	- 14 -
6.1.- DETAIL INFORMATION OF MENU "REAL-TIME MONITORING"	- 14 -
6.2.- DETAIL INFORMATION OF MENU "WAVEFORM CAPTURE"	- 16 -
6.3.- DETAIL INFORMATION OF MENU "SEQUENCE OF EVENT"	- 17 -
6.4.- DETAIL INFORMATION OF MENU "POWER QUALITY"	- 18 -
6.5.- DETAIL INFORMATION OF MENU "SYSTEM CONFIG"	- 23 -
6.6.- DETAIL INFORMATION OF MENU "CONTACT US"	- 32 -
7.- PULSE OUTPUT	- 33 -
8.- COMMUNICATION INTERFACE	- 34 -
8.1.- CONNECTION FOR RS485 BUS	- 34 -
8.2.- MODBUS © PROTOCOL	- 35 -
8.3.- REGISTER MAP	- 36 -
8.4.- EXAMPLE	- 52 -
9.- SAFETY CONSIDERATIONS	- 52 -
10.- MAINTENANCE	- 53 -
11.- TECHNICAL SERVICE	- 54 -

1.- SUMMARIZE

APM-96Q Multi-Function Power Meter is a highly advanced and intelligent device designed for medium and low-voltage power systems. The meter is equipped with energy measurement and calculation capabilities, enabling precise power monitoring, energy accumulation, and comprehensive system analysis. It is designed to measure both basic and advanced electrical parameters, including multi-tariff energy data, waveform capture, harmonic analysis, demand recording, etc.

It can measure all power parameters in power grid:

Current,	Apparent power,	Voltage and current THD%,
Voltage,	Energy (Active/Reactive),	Harmonics factor,
Frequency,	Power factor,	Voltage crest factor,
Active power,	Fundamental current/ voltage	Current K-factor,
Reactive power,	Phase angle detection	Multi-tariffs ratio,
Demand record,	Current harmonics 2~127 times,	30 lists waveform capture,
5* Alarm threshold	Voltage harmonics 2~127 times,	Voltage/ current unbalance,
50 lists SOE record,	Voltage/frequency deviation,	Voltage sag/ swell/ flickers/ fluctuation

APM-96Q supports RS485/ Modbus-RTU communication, with optional Ethernet (Modbus-TCP/RTU) and PROFIBUS-DP interfaces for reliable and efficient data exchange.

Additionally, APM-96Q can option up to 6 channel digital input (DI), 4 channel digital output (DO), and 3 channel analog outputs (AO), enabling flexible integration with external systems.

FEATURES

- Small-size (96 x 96 mm), panel mounting meter;
- True R.M.S. measuring system;
- High accuracy power quality analysis;
- With up to 12,800/s high-speed sampling chip;
- Instantaneous, maximum and minimum values of each measured parameter;
- RS485/Modbus RTU communication to a PC.

APPLICATIONS

- Monitor and control, energy measurement and electrical fire;
- Replace the three-phase power meter, three phase electricity transmitter;
- Transformers, generators, capacitors and electric motors distributed detection;
- Medium and low voltage systems;
- SCADA, EMS, DCS integrators.

2.- FEATURES

2.1.- Electricity Metering

By means of an internal microprocessor it simultaneously measures:

Parameter	Symbol	A phase	B phase	C phase	Total
Single phase voltage	V	●	●	●	/
Phase-line voltage	V	●	●	●	/
Phase-phase voltage	V	●	●	●	/
Current	A	●	●	●	/
Frequency	Hz	/	/	/	●
Power factor	Cos Φ	●	●	●	●
Active power	W	●	●	●	●
Reactive power	Var	●	●	●	●
Apparent power	VA	●	●	●	●
Active energy	Wh	●	●	●	●
Reactive energy	Varh	●	●	●	●
Multi-tariffs energy record	Wh	/	/	/	●
Max demand (W / var / VA)	MAX	/	/	/	●
Voltage / frequency deviation	V	●	●	●	/
Voltage / current unbalance	%	/	/	/	●
Voltage sag, swell, flicker, fluctuation	/	/	/	/	●
THD & Harmonic (2~127 th)	THD	●	●	●	●

●: Display and communications

○: Optional functions

/: No such function

Note:

Phase-phase voltage is Uab, Ubc, Uca, voltage data determined by the different wiring.

APM-96Q delivers the visualization of parameters listed above by means of color LCD displays. the main display area shows 4 rows power parameters, with other display area show the various parameters and state of meter on each page jump. For more details of measurement parameters please refer to the subsequent for displays introduction and RS485 communication instructions.

2.2.- Technical parameters

- Working power

AC/DC 85-265V, (DC 48V or AC 380V customized)
40-65Hz
Consumption: 4W

- Reference standard

Basic electricity	IEC 61557-12:2016
Active energy	IEC 62053-21:2018
Reactive energy	IEC 62053-23:2018

- Input

Voltage	AC100V, 220V, 380V (please specify when ordering)
Current	AC 1A/5A (please specify when ordering)
Frequency	40~65Hz, accuracy class: $\pm 0.02\text{Hz}$
Current overload	Measurement: 1.2 times Instantaneous: 10 times/1s
Voltage overload	Measurement: 1.2 times Instantaneous: 2 times/10s

- Output

Communication	RS485, Modbus-RTU or optional Ethernet, Modbus-RTU/ TCP
Pulse output	optional 1- 2 channel
DI	optional 1-6 channel, dry contact, $R_i < 500\Omega$ turns on, $R_i > 100k\Omega$ turns off
DO	optional 1-4 channel, load capacity: 5A@250VAC; 5A@30VDC
AO	optional 1-3 channel, current 4~20mA, load $< 390\Omega$, Voltage 0~10V, load $> 100k\Omega$

- Load

Voltage: $< 0.1\text{VA}$ / phase (rated 220V)
Current: $< 0.4\text{VA}$ / phase (rated 5A)

- Safety

4kV AC RMS 1 minute, between input / output / case / power supply
Input, output and power supply to the chassis $\geq 100\text{M}\Omega$

- Accuracy

Parameter	Accuracy	A phase	B phase	C phase	All
Voltage	0.1	V1	V2	V3	
Current	0.1	A1	A2	A3	
Active power	0.2	W1	W2	W3	W
Reactive power	0.5	var1	var2	var3	var
Apparent power	0.2	VA1	VA2	VA3	VA
Power factor	0.5	PF1	PF2	PF3	PF
Active energy	0.2				Wh
Reactive energy	1.0				Varh
Apparent energy	0.2				VAh
Frequency	0.01				Hz

Others

Deviation accuracy	Voltage: 0.2%; Frequency: 0.02%
Unbalance accuracy	Voltage: 0.2%; Current: 0.2%
Voltage flicker accuracy	5%
U/I phase angle accuracy	0.1°
Harmonic content	When $U_h > 2\%$: $5\%U_h$; when $U_h \leq 2\%$: $0.1\%UN$
Demand record	Maximum monthly demand in the past three months
Multi- tariffs ratio	3 months energy data record, 4 sets rates, 12 segments
Display screen	320X240 colorful LCD
SOE record	50 lists, (10 lists DI/DO SOE; 40 lists Alarm SOE)
Alarm threshold	Default 5 channels
Data sampling rate	12,800 samples/second (256 samples per cycle @ 50 Hz)
Data upload rate	0.5s

- Environment

Working temperature: $-10^{\circ}\text{C} \sim +55^{\circ}\text{C}$; RH 20% ~ 95% (non-condensation), altitude $\leq 2000\text{m}$
 Storage temperature: $-30^{\circ}\text{C} \sim +70^{\circ}\text{C}$; RH 20% ~ 95% (non-condensation), altitude $\leq 2000\text{m}$

3.- INSTALLATION AND START-UP



The manual you hold contains information and warnings that -users should follow in order to guarantee a proper operation of all the instrument functions and keep it in safety conditions. The instrument must not be powered on and used until its definitive assembly is on the cabinet's door.

If the instrument is not used as manufacturer's specifications, the protection of the instrument will be damaged.

When any protection failure is suspected to exist (for example, it presents external visible damages), the instrument must be immediately powered off. In this case contact a qualified service representative.

3.1.- Installation

Mounting

Instrument is to be mounted on panel (cut-out $91+0.8 \times 91+0.8 \text{ mm}$). Keep all connections into the cabinet.

Please note that as the instrument be powered on, the terminals could be dangerous to touch and cover opening actions or elements removal may allow accessing dangerous parts. Therefore, the instrument must not be used until this is completely installed.

Dimension:

Unit: mm

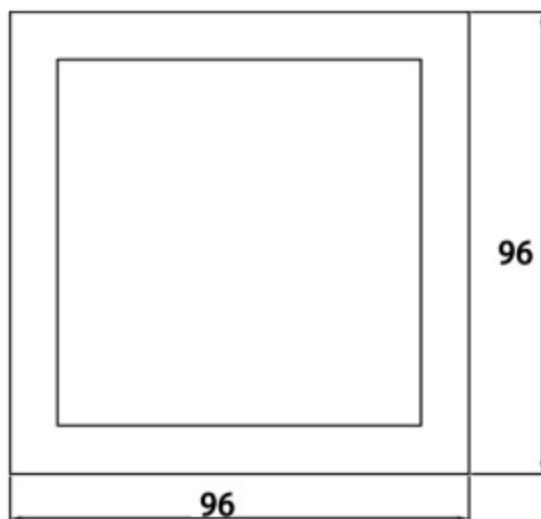

Front view

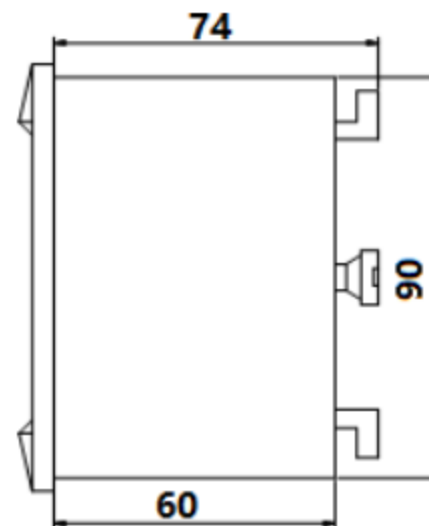

Side view

Notes:

Input signal: APM-96Q using a separate acquisition calculate for each measurement channel, to ensure consistent in use, for different load forms, it's a variety of connection mode. Access wire shall be met 2.5 square mm.

A. Voltage input

Input voltage should not exceed the rated input voltage products 450V.
Otherwise, you should use external VT. Suggest 1A fuse be installed in the voltage input side.

B. Current Input

Standard input current is 5A or 1A, if greater than 5A/1A should use external CT.
When the CT is connected with other meters, make sure wiring methods be used in series.

Warning: Forbid to install a CT on the live feeder wire with open secondary leads. This can be extremely dangerous!

Before remove the current input connection, must be sure to disconnect the primary circuit or shorted secondary circuit of CT.

C. Sequence of wire

Warning: Please make sure that the input voltage and current corresponding to the same phase, sequence, and the same direction; Otherwise, the Values and symbols will be wrong! (Power and Energy)

Always observe the physical orientation of CT (P1 - P2) when installing on the feeder wire.
Always pay attention to wiring polarity and phasing when terminating the CT leads to the APM-96Q.
S1 connect to Ix*, S2 connect to Ix.

The input network configuration of instrument depends on the CT number of the system:
in the condition of 2 CT, select the three-phase, three-lines two components;
in the condition of 3 CT, select the three-phase, four-lines three component mode.

Instrument connection mode, set of the instrument (programming input network NET) should be the same load wiring as measured wiring. Otherwise, the measurement instrument will lead to incorrect voltage or power.

In three-phase 3 wire mode, measurement and shows the line voltage;

In three-phase 4 wire mode, measurement and shows the phase voltage and line voltage both.

D. Auxiliary power

APM-96Q with universal (AC / DC) power input, if not for a special statement, we provide the 90-240AC/DC power interface for standard products, please ensure that the auxiliary power can match with meter to prevent unexpected damage.

- A. Suggest install 1A fuse in the fire line side.
- B. For the areas with poor power quality, suggest install lightning surge suppressor and rapid burst suppressor to prevent lightning strikes.

3.2.- Connection Terminal

Upper-15pin: (Power supply and function output)

No.	Marked	Notes
1	L	AUX input 85-265Vac/dc
2	N	
58	RS485	RS485+
59		RS485-
47	Pulse output	Pulse output+
48		Pulse output-
70 71 72 73 74	4 DI	4 channel digital input
19 20 21 22	2 DO	2 channels digital output

Upper-11pin: (Power supply and optional AO)

No.	Marked	Notes
1	L	AUX input 85-265Vac/dc
2	N	
58	RS485	RS485+
59		RS485-
47	Pulse output	Pulse output+
48		Pulse output-
/	/	/
15 16 15 17	2 AO	2 channels analog output

Upper-15pin: (Power supply, 2* communications and optional AO)

No.	Marked	Notes
1	L	AUX input 85-265Vac/dc
2	N	
47	Ep+ / Ep-	Active energy pulse output+
48		Active energy pulse output-
49	Eq+ / Eq-	Reactive energy pulse output+
50		Reactive energy pulse output-
58	RS485-1	Channel 1 RS485+
59		Channel 1 RS485-
61	RS485-2	Channel 2 RS485+
62		Channel 2 RS485-
15-18	3 AO	3 channels analog output

Lower-10pin: Signal





No.	Marked	Notes
11	Ua	Voltage A-phase input
12	Ub	Voltage B-phase input
13	Uc	Voltage C-phase input
14	Un	Neutral Voltage input
8	C-phase Current	Current C-phase - S1 input
9		Current C-phase - S2 input
6	B-phase Current	Current B-phase - S1 input
7		Current B-phase - S2 input
4	A-phase Current	Current A-phase - S1 input
5		Current A-phase - S2 input

Note:

The terminal pin definition may change depends on customer order; please refer to the label on the meter!

4.- OPERATION MODE

When the device is powered on, the entire symbol will be on, and the meter starts to self- test. After few seconds, the meter is ready for operation and shows firmware, then automatic jump to The first screen.

Button	In Monitor Screen	In Config Sub-menu	In Parameter Setup
	Screen will move to previous or next page	Move cursor up and down to select function	Move setting cursor to left
			Scroll selection number 0 ~ 9
	Call out password screen	Exit & roll back to up level menu.	
	Call out sub-screen or version screen	Confirm the values & Entry or jump to down level menu	

Note: In Setup menu, if change the setting value, press  for exit menu, device will call out confirm screen ask "SAVE"

Then press  *exit without saving;*

press  *save and exit.*

5.- SCREEN DISPLAY

5.1.- Overall menu screen

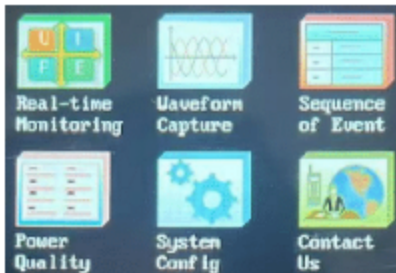

- **Real-time Monitoring:** Real-time measurement values of electrical parameters: current, voltage, power, energy, time of use, max demand, etc., [Details see chapter 6.1.](#)
- **Waveform Capture:** Total/Split-phase current and voltage waveform analysis graph, [Details see chapter 6.2.](#)
- **Sequence of Event:** 10 lists DI/DO action event records, 40 lists alarm event records, and 30 lists waveform capture records, [Details see chapter 6.3.](#)
- **Power Quality:** Power quality analysis, current/frequency deviation, current and voltage unbalance, harmonic analysis, voltage dip, flicker, fluctuation and other parameters real-time values, [Details see chapter 6.4.](#)
- **System Config:** Device password, power grid mode, communication, extension module and other parameter configurations, [Details see chapter 6.5.](#)
- **Contact Us:** Device version and real-time clock information, [Details see chapter 6.6.](#)

6.- Detail parameter screen

6.1.- Detail information of menu “Real-time Monitoring”

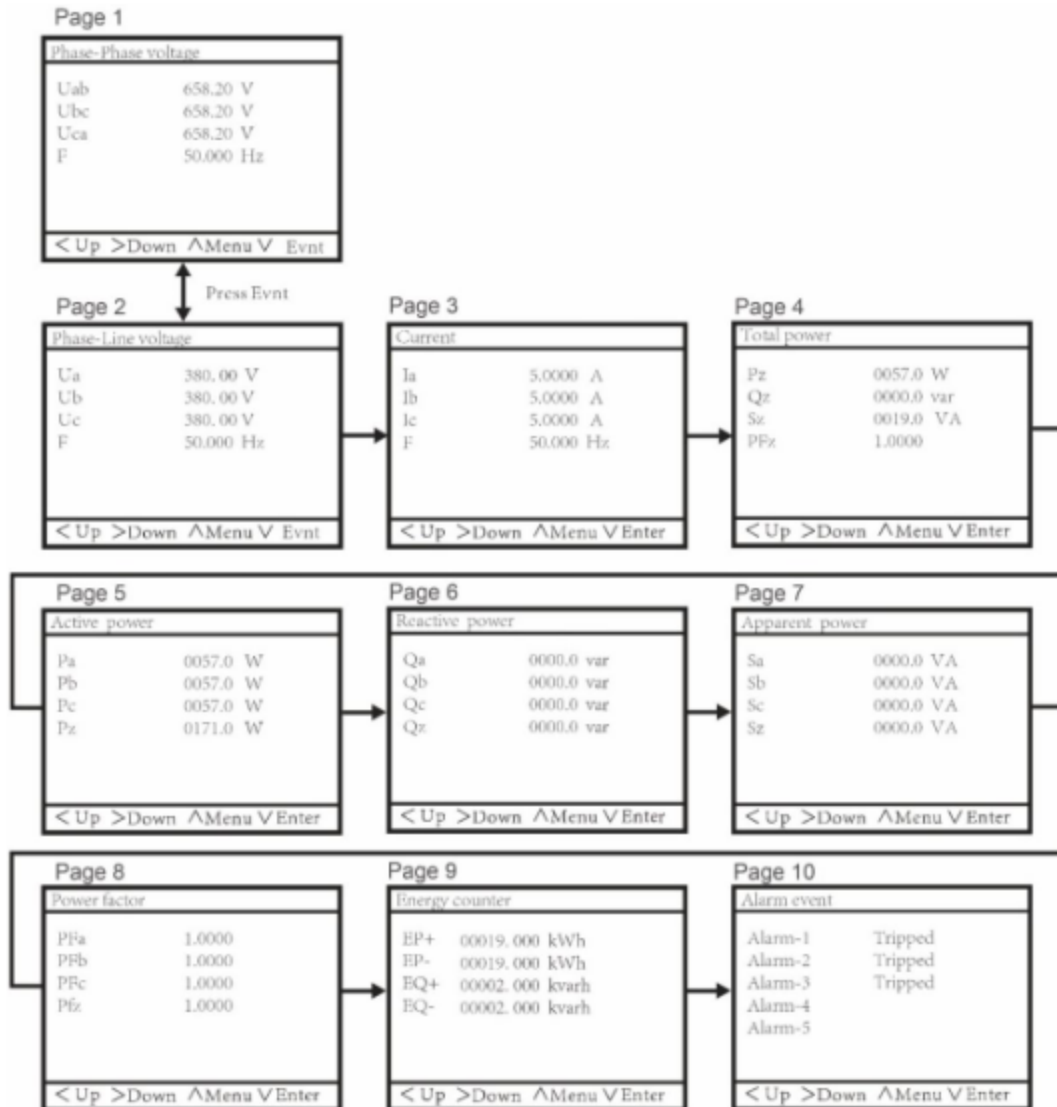

- Page 1** Phase-phase three phase voltage and frequency
- Page 2** Phase-line three phase voltage and frequency
- Page 3** Three-phase current and frequency
- Page 4** Total active power/ reactive power/ apparent power/ power factor
- Page 5** Total and individual phase active power
- Page 6** Total and individual phase reactive power
- Page 7** Total and individual phase apparent power
- Page 8** Total and individual phase power factor
- Page 9** Total positive/ negative active power and reactive energy count
- Page 10** Alarm 1-5 status: tripped/null

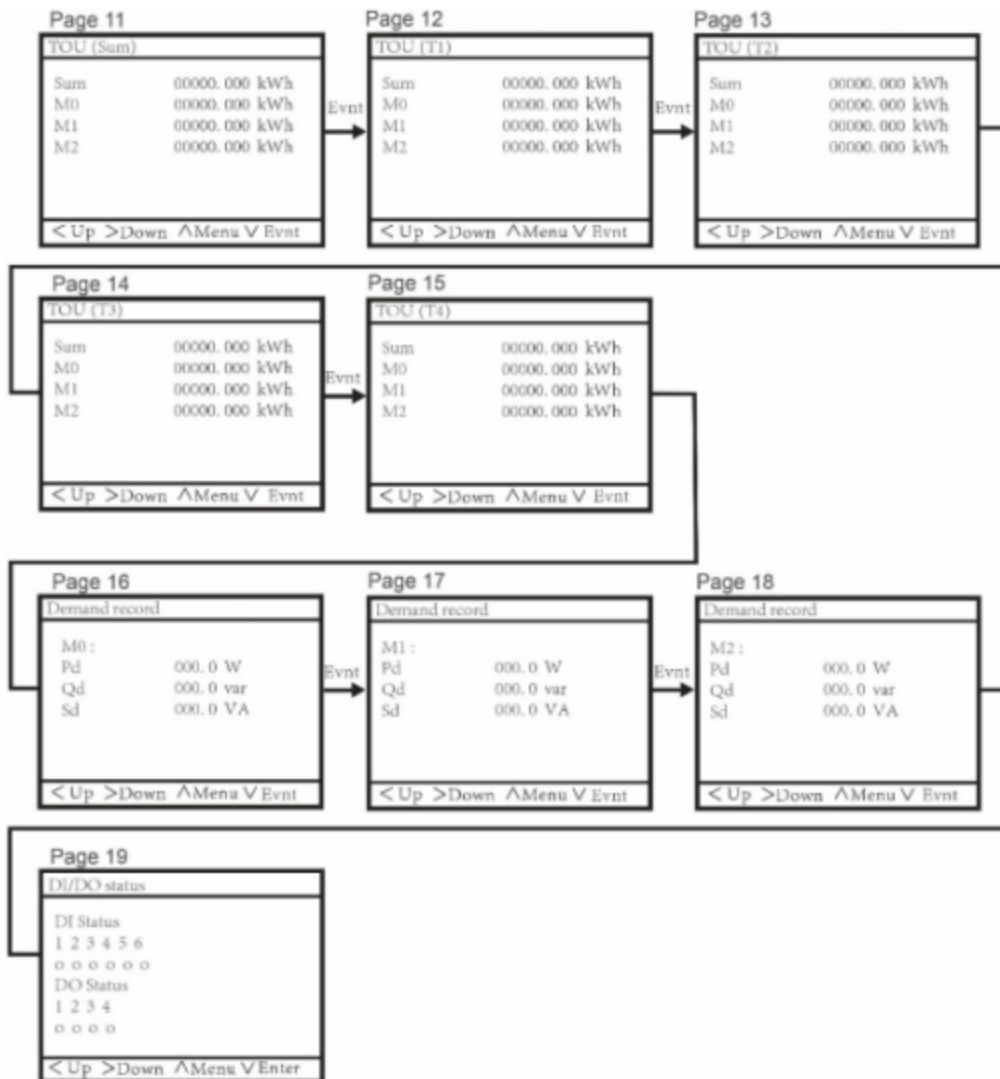

Page 11-15: Time of use /Multi tariff record

Sum: M0+M1+M2 total cumulative energy

M0: Present month

M1: Last month

M2: Month before last month

T1: TOU mode-1

T2: TOU mode-2

T3: TOU mode-3

T4: TOU mode-4

Page 16-18: Total demand record

M0: Present month

M1: Last month

M2: Month before last month

Pd: Maximum active power demand

Qd: Maximum reactive power demand

Sd: Maximum apparent power demand

Page 19: DI/DO status

○: opened

●: closed

6.2.- Detail information of menu “Waveform Capture”

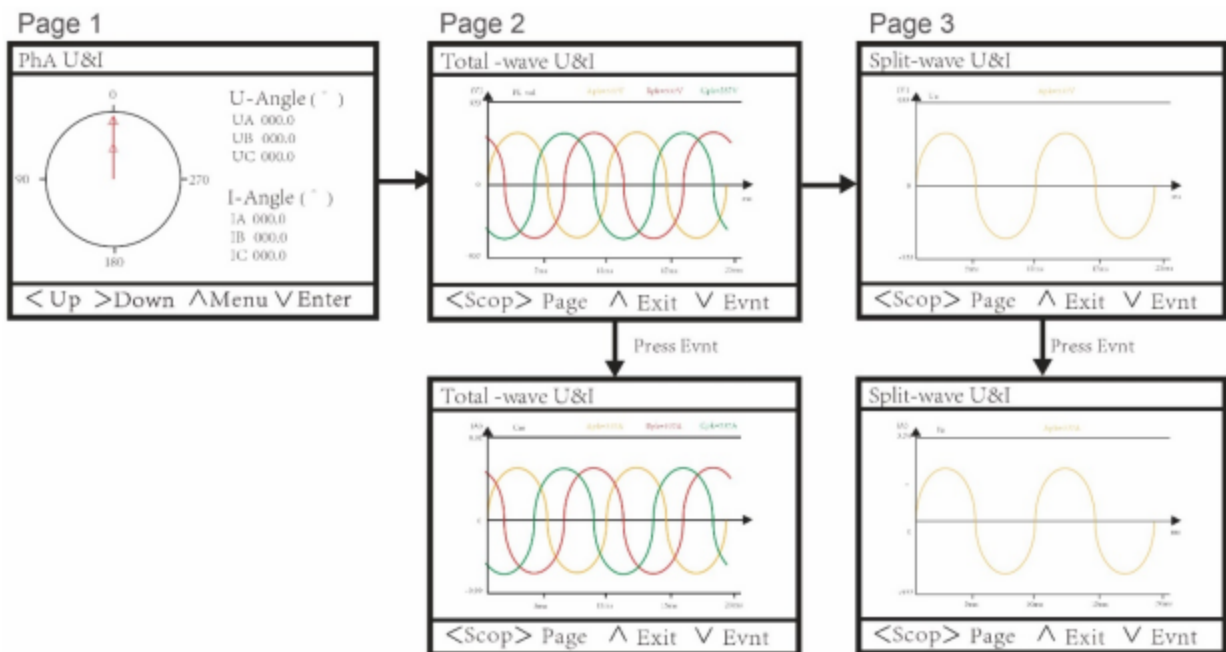

Page 1: A, B, C phase current and voltage phase angle.

Page 2: A, B, C phase total voltage waveform, press “Evnt” can view total current waveform.

Page 3: A, B, C split phase voltage waveform, press “Evnt” can view split phase current waveform.

Note:

APM-96Q equipment high-speed sampling chip with up to 12,800 samples per second, meter can store up to 30 lists fault waveform records. Each record contains 7200 data points for three-phase voltage and current, covering 1 second. If the standard 50Hz power grid, 144 points of data are saved in each cycle, for a total of 50 cycles (25 cycles before the fault and 25 cycles after the fault is triggered).

Due to measurement errors and delays, the waveform at the fault point may appear in the 15th to 20th cycle). The first item is the most recent recording, and the following items are recorded in order.

Data reading method:

Use function 06 to write the desired record number to register 0x920.

Use function 03 to read the fault waveform data starting from register 0x2AF8, up to 125 registers per read. Details see [chapter 8.3.8](#).

6.3.- Detail information of menu “Sequence of Event”

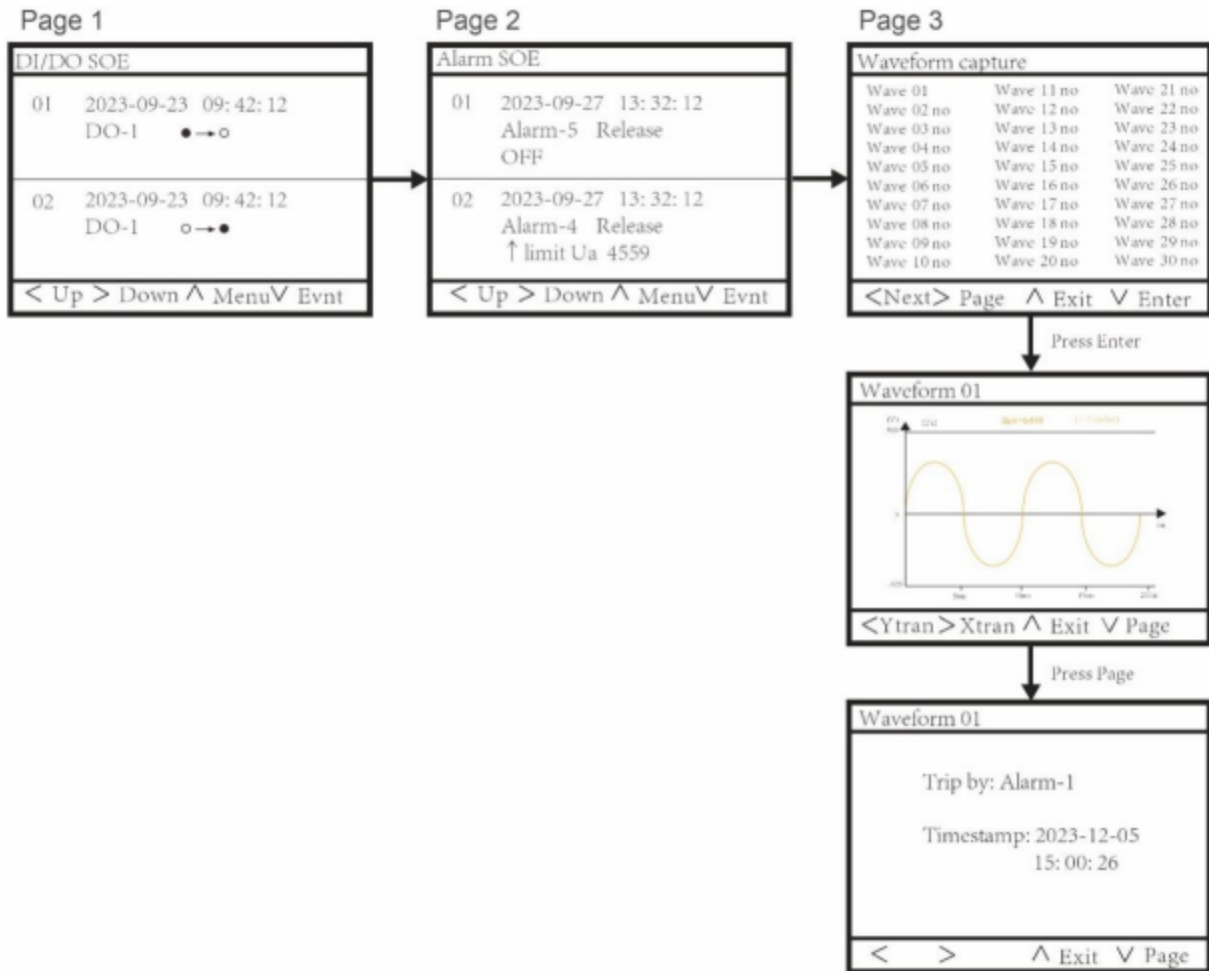

Page 1: Sequence of event record of DI/DO action status, Max 10 lists, ○ stand for relay opened, ● stand for relay closed.

Page 2: Sequence of event record of alarm events: alarm time, alarm status (release/ capture), alarm parameters and value.

Page 3: Sequence of event record of waveform capture, in this page press “Enter” can view A, B, C phase X&Y-axis current and voltage waveform. and then press “Page” can view the specific events and the timestamp.

6.4.- Detail information of menu “Power Quality”

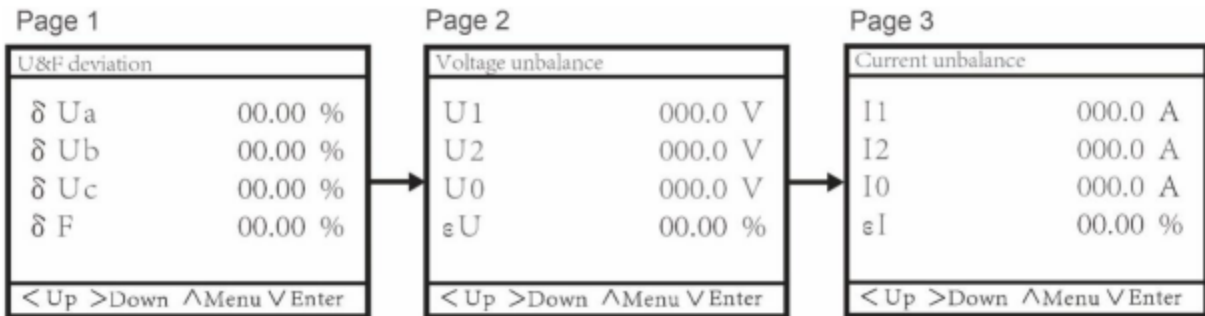

Page 1: A, B, C phase voltage and frequency deviation

Page 2: Voltage unbalance

- U1:** Positive sequence voltage
- U2:** Negative sequence voltage
- U0:** Zero sequence voltage
- ϵU : Voltage unbalance (%)

Page 3: Current unbalance

- I1:** Positive sequence current
- I2:** Negative sequence current
- I0:** Zero sequence current
- ϵI : Current unbalance (%)

Note: Device real time measures and calculate the above data and updates data per 0.5 seconds for both the screen and through RS485 communication.

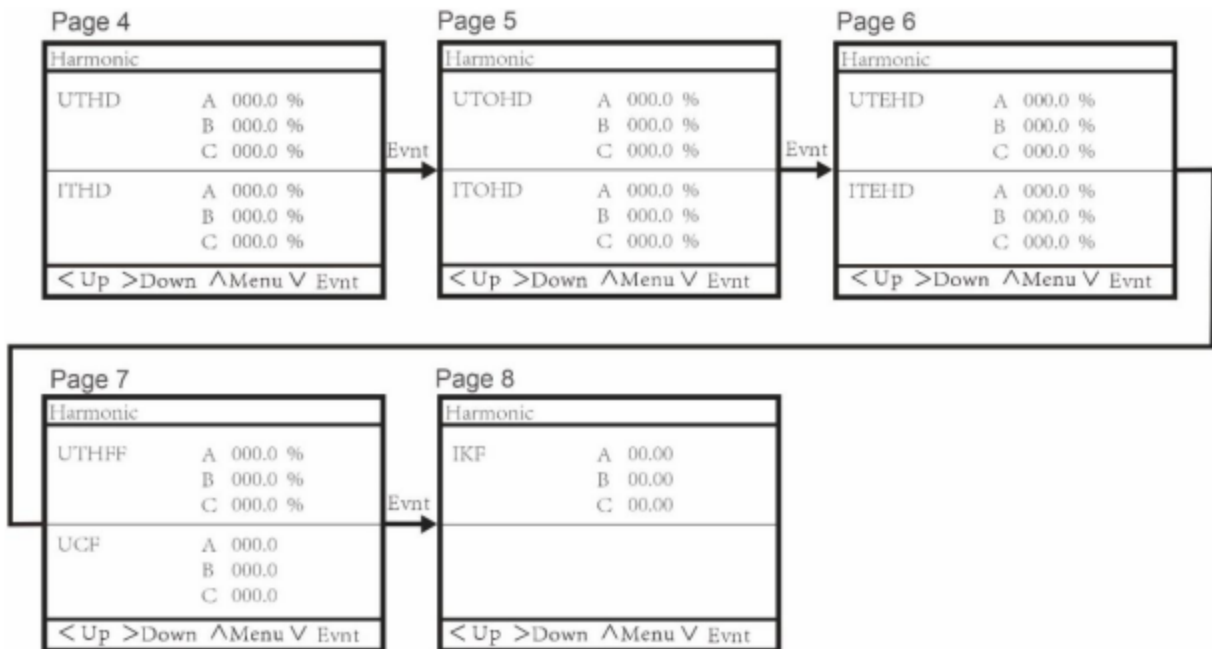

Page 4: Voltage and current total harmonic distortion

Page 5: Voltage and current total odd harmonic distortion

Page 6: Voltage and current total even harmonic distortion

Page 7: Voltage and current telephone harmonic factor

Page 8: Current K factor

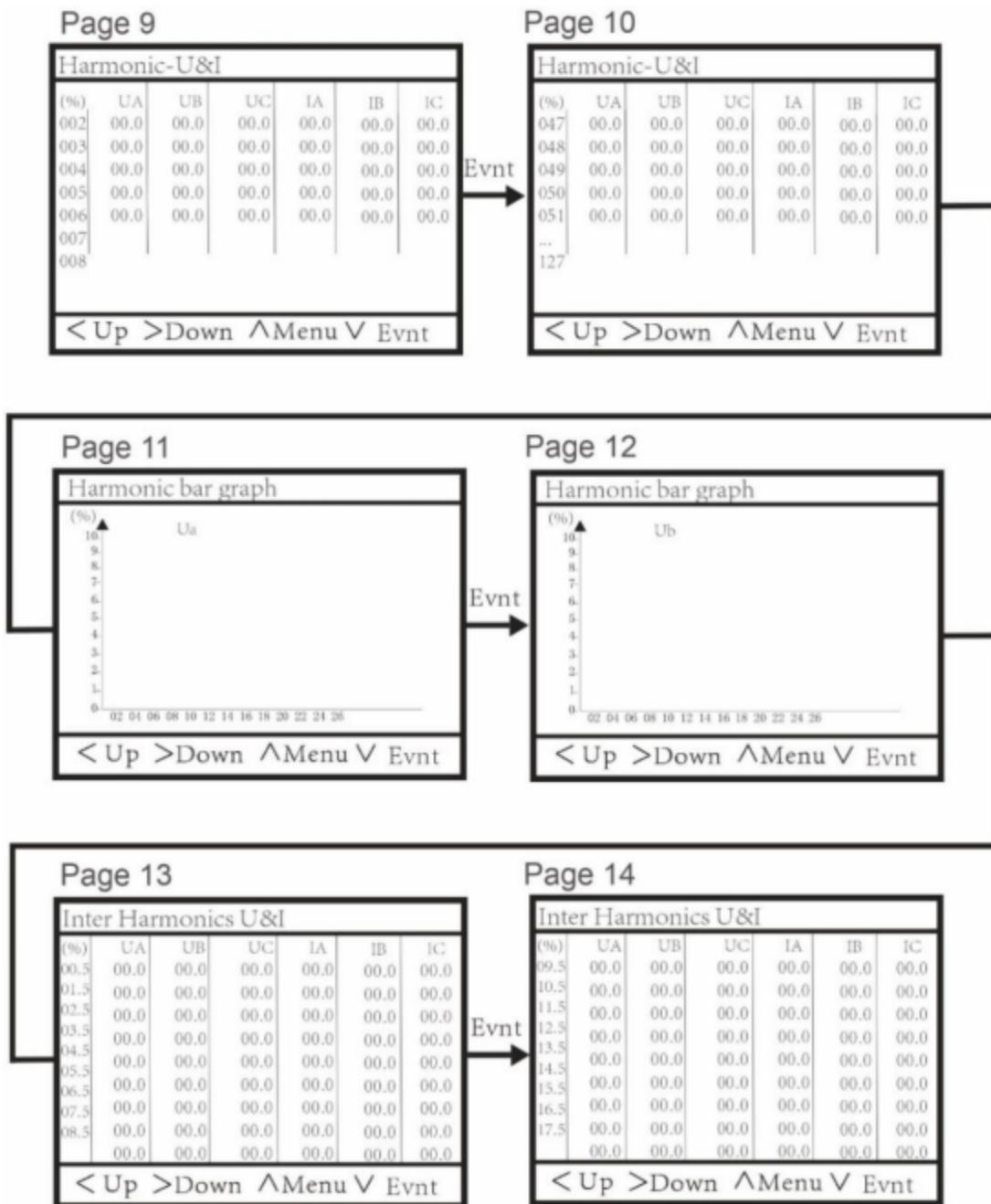

Page 9-10: Voltage and current individual harmonic components 2 to 127th

Page 11-12: Individual harmonic component bar graph (Ua,Ub,Uc, Ia,Ib,Ic)

Page 13-14: Three phase voltage and current inter harmonic components 0.5- 63.5th

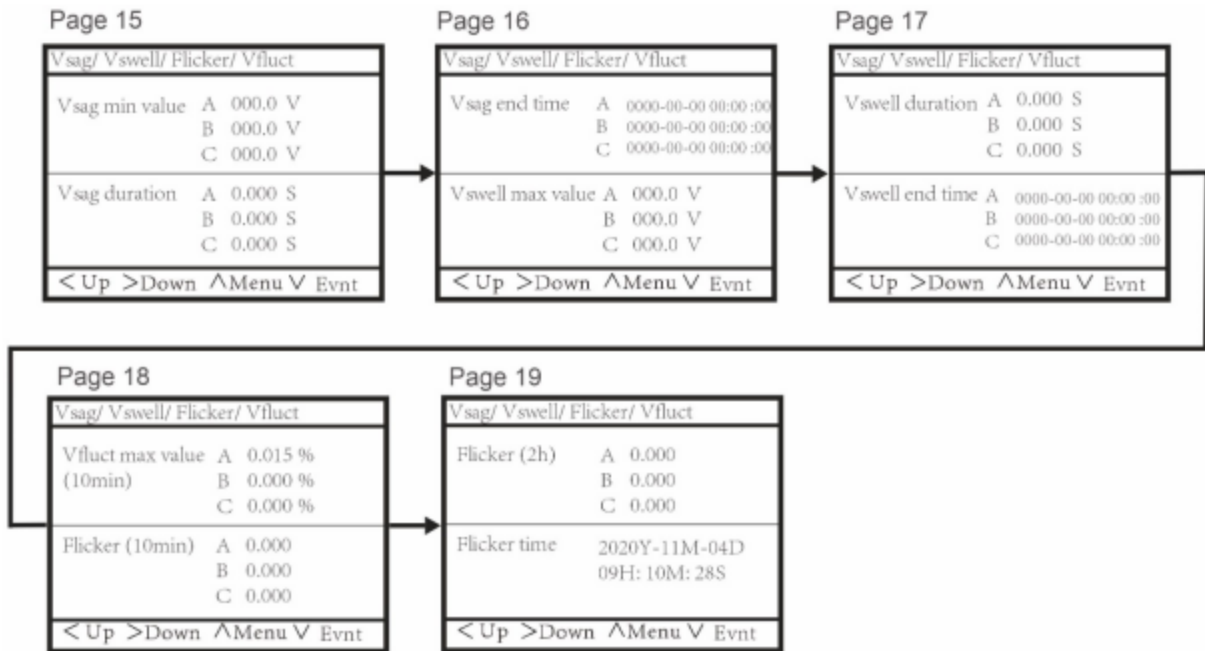

Page 15 ABC phase voltage sag min value and duration time.

Page 16 ABC phase voltage sag end time and voltage swell max value.

Page 17 ABC phase voltage swell duration time and end time.

Page 18 Voltage fluctuation max value in latest 10min and voltage short-term flicker severity (in latest 10min).

Page 19 Voltage long-term flicker severity (in latest 2h) and short-term flicker and voltage fluctuation update time.

Note:

Device analyzes and calculates data via internal software, updating short-term flickers every 10 minutes and long-term flickers every 2 hours. Real-time updated data is available on both the screen and through RS485 communication.

Page 19

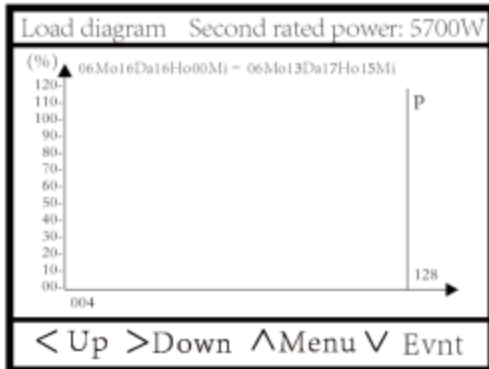
**Page 19:** Load data storage (optional function)**Note:**

When option the function, the device will record three-phase voltage, current, active/reactive power, average apparent power, active/reactive energy per 15 minutes. It stores data for up to 1 year and displays the load curve on screen.

6.5.- Detail information of menu “System Config”

In this menu, enter default password **0001** can enter the parameter settings:

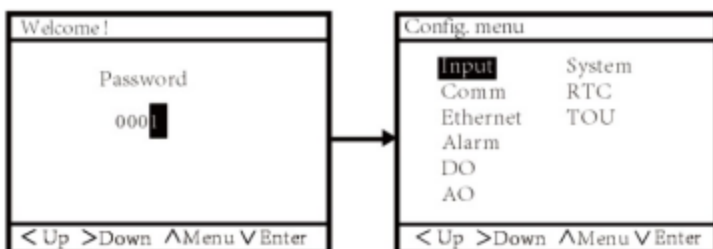

6.5.1.- Input setting

Input	
Line	3P4L
Voltage	380V
R. Curr.	5A
PT ratio	0001
CT ratio	0001

< Up >Down ^Menu vEnter

Power grid mode ^{1*}

Rated voltage

Rated current

Voltage transformer ratio ^{2*}

Current transformer ratio

Notes:

- 1.- Power grid mode: default 3P4L, Optional 3P3L, 3P3L3CT and 3P3L2CT; In 3P3L mode, shorted Ub and Un external are needed.
- 2.- In 380V range please set PT ratio to 1; in 100V range users can set PT ratio to expand measurement range.

6.5.2.- RS485 communication setting

Comm		
Comm-1	ID	001
	Baud	9600
	Mode	n.8.1

< Up >Down ^Menu vEnter

RS485 communication address:1-247

RS485 communication baud ratio: default 9600, optional 2400 / 4800/ 9600 / 19200

RS485 communication data mode: default n.8.1, optional n.8.1 / e.8.1 / n.8.2

6.5.3.- Ethernet communication setting

Ethernet	
Modbus ID	001
Work mode	TCP-server
Type	Modbus-TCP
Dest. IP	220.155.221.243
Dest. port	16254

< Up >Down ^Menu vEnter



Ethernet	
IP protocol	Static
Locl. port	16254
Locl. IP	192.168.000.007
Sub mask	255.255.255.001
Gateway	192.168.000.001

< Up >Down ^Menu vEnter

Modbus address

Work mode: TCP/UDP-server/client

Type: Modbus-RTU/ Modbus-RTU TCP

Destination IP

Destination port

IP protocol: Static IP/DHCP

Local port

Local IP

Sub mask

Gateway

Note: To avoid unnecessary remote writing failure, TCP port cannot configure or read via register operation, only can manually set!

6.5.4.- Alarm setting

APM-96Q provides 5* alarms for remote communication, defined in “Alarm-1”, “Alarm-2” ... “Alarm-5”. When the meter detects that the parameter is up to or down to pre-setting limit, it will be shown in register and SOE. If the meter is equipped with physical DO port, the relay can be tripped by the linkage configuration.

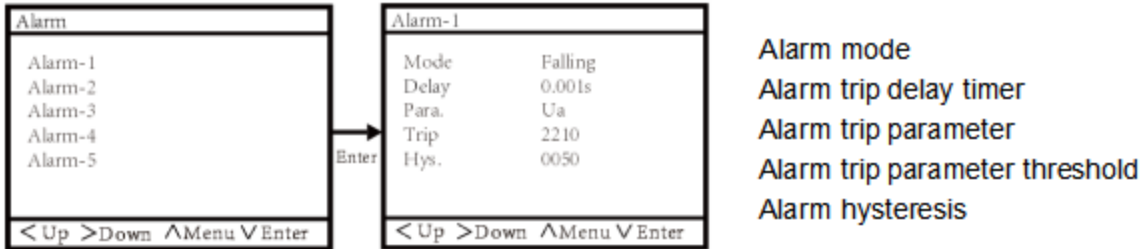

Alarm setting description

Sub-setting	Settings value	Definition
Mode	OFF / Upper Limit / Lower Limit	Default OFF
Delay*	0.1~999.9s	After the preset parameter is over the setting value in the specified delay, Virtual Alarm will be tripped. Default 0.1s
Parameter	$U_a / U_b / U_c / U_{ab} / U_{bc} / U_{ca} / U_{abc}$ $I_a / I_b / I_c / I_{abc}$ $P_a / P_b / P_c / P_s$ $Q_a / Q_b / Q_c / Q_s$ $S_a / S_b / S_c / S_s$ PF / Fr $DI_1 / DI_2 / DI_3 / DI_4 / DI_5 / DI_6$	Parameter be tripped Notes: U_{abc}, I_{abc} mean any value in phase P_s, Q_s, S_s mean total value in three phase Not all values above are displayed on the setting screen. It depends on sub-mode of APM-96Q
Value	0~9999	Trip threshold, value related to secondary side, units: Voltage - 0.1V Current - 0.001A Active power - 0.1W Reactive power - 0.1VAR Power factor - 0.001 Frequency- 0.01HZ Default is 5500
Hysteresis*	0~9999	When the measurement parameter falls back lower / over this exceed value, the alarm will be released. Default is 0050

Delay & Hysteresis operation logic

An example in upper limit alarm of A phase voltage:

U-d means detected U_a

U-set mean Alarm value of A phase

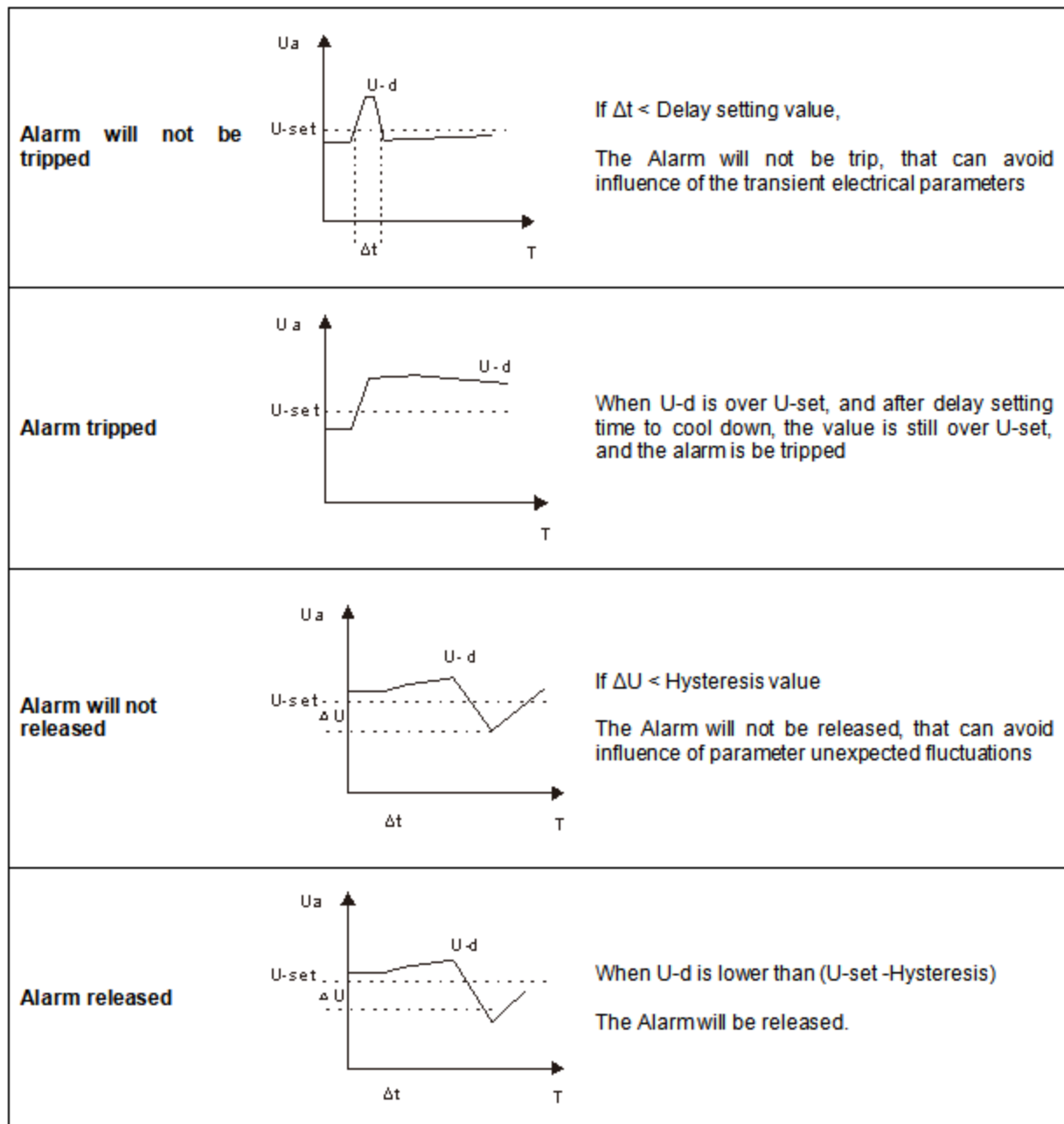

6.5.5.- Digital output setting

When the device has more than one DO port, users can set the DO-2, DO-3...as same step. the physical DO relay standard is 5A@250VAC / 5A@30VDC.

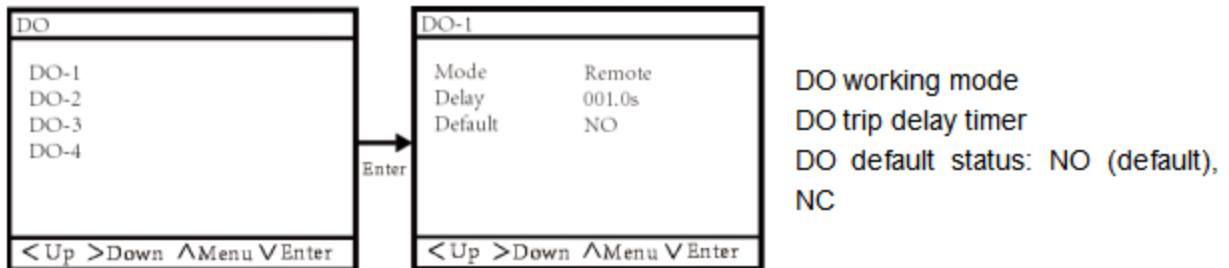

Relay setting description:

Sub-setting	Settings value	Definition
Mode	Remote* / [Alarm-X] [OFF] / [ON]	[Remote] - DO is acted by RS-485 control command [Alarm-X] - DO acts when Alarm-X is tripped [OFF] – DO is always closed, cannot control [ON] – DO is always opened, cannot control Default Remote
Time	0.0~999.9s	000.0 - Level type signal, contact coil will be closed when it is tripped 000.1~999.9 - Pulse type signal, value for width. Contact coil will be closed in the pulse width time, then release Note: In [Alarm-X] the value setting is valid Default 0.1s
Default	NO (Normally open) NC (Normally close)	[NO] mode: when power on, relay keep idle, when alarm signal occurs, it will active. [NC] mode: when power on, relay will active first, then alarm signal occurs, it will release. Default NO

Remote mode operation

In "Remote" mode, users can use the function code 05 to trip single relay, and the device RS-485 port follow MODBUS-RTU protocol, command as following:

Host inquiry:

Address	Code	No.1 Relay register	Relay value (FF00: close; 0000: open)	CRC
01	05	00 01	FF 00	DD FA

Relay value: FF00 means close, while 0000 means open.

Slave response:

Address	Code	No.1 Relay register	Relay value (FF00: close; 0000: open)	CRC
01	05	00 01	FF 00	DD FA

6.5.6.- Analog Output setting

APM-96Q optional max 3* Analog output port, which can generate analog signal to downstream equipment.

AO
AO-1
AO-2
AO-3

Enter

AO-1	
Mode	4-20
Para.	Ua
Scale-0	0000
Scale-F	5000
Cal.4mA	0260
Cal.20mA	0780

Analog output current signal range
 Analog output signal parameter
 Transfer parameter value of zero span
 Transfer parameter value of full span
 Calibration 4mA
 Calibration 20mA

Basic specification:

AO output type	Output 4 ~ 20mA / 0~20mA or 1 ~ 5V
Accuracy class	0.5S
Overload	120% effective output, the maximum current of 24mA, voltage 15V
Load	$R_{max} = 420\Omega$
Isolation	1kV to other terminal (Between AO-AO port non-isolation)

Analog output setting:

Sub-setting	Settings value	Definition
Mode	4-20 / 12-20 / 0-20 0-5 / 0-10	Output current signal range, unit mA Default 4-20
Parameter	$U_a / U_b / U_c / U_{ab} / U_{bc} / U_{ac}$ $I_a / I_b / I_c / PF / Fr$ $P_a / P_b / P_c / P_s$ $Q_a / Q_b / Q_c / Q_s$ $S_a / S_b / S_c / S_s$	Parameter that can be set Default: Ua
Scale-0	0~9999	Zero scale value for transmission output, units: Voltage - 0.1V Current - 0.001A Active power - 0.1W Reactive power - 0.1VAR Power factor - 0.001 Frequency- 0.01HZ Default is 0000
Scale-F	0~9999	Full scale value for transmission output, units are same with LDIS Default is 5000

Note: If do not select AO output module, this menu cannot be accessed.

6.5.7.- System setting

System	
Password	0001
Rotate	Manual
Rec. intvl	disable
Erase	All
Style	3
Cutoff Volt	0020
Cutoff Curr.	0010
Lauguage	English
< Up >Down ^Menu v Enter	

Change password
 Screen scroll interval
 Data record Interval: disabled
 Erase energy record
 Display style:1-9
 Shield voltage: Small signal shielding value
 Shield current: Small signal shielding value
 Language: English by default, cannot be set

Notes:

- 1.- If change the password, please keep the password in safety, or only return to Blue Jay for reset new password!
- 2.- Customers can write commands through RS485 or through the screen to clear the energy data to 0. Once the secondary side value of the internal memory reaches to 232(4294,967,296), the counter automatically reset to 0.

6.5.8.- Real-time clock setting

RTC	
Year	2024
Month	12
Date	12
Hour	08
Minute	23
Second	04
Week	Thursday
< Up >Down ^Menu v Enter	

Users can set:
 Year / Month / Date / Hour / Minute / Second
 And week

Note:

Before shipping Blue Jay will set RTC to local time zone, if need other time zone presetting, please contact our sales team or reset the RTC in meter setup.

6.5.9.- Time of use/multi-tariff setting

APM-96Q provides the last 3 months of TOU energy record. The TOU function separates one day into 12 segments billing interval, using T1-T4 tariff to indicate energy consumption in different time segments and record in memory. There are 4 different TOU billing modes which can be selected for different months in one year.

Users can get monthly energy data from panel display screen or RS485 (RS485 data refers to Communication protocol) and calculate their energy cost in different tariff periods.

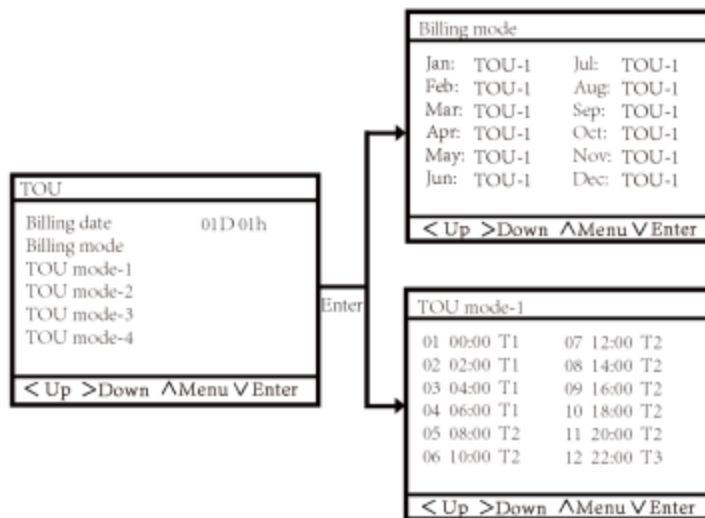

- **TOU billing date:** default 01D 01h, can select date 1-28 for every month and hour clock 00-22.
- **Billing mode:** Set every month billing mode, there are 4 types of TOU ratio can be selected.
- **TOU mode:** Set TOU mode-1 to mode-4 tariff.

Notes:

1.- Meter default automatic billing time meter reading time at 0:00 on the 1st of each month. Electrical energy of this month will be freeze to last month value, and the electrical energy of last month will be frozen to the month before last month. Electrical data of this month will clear and re-start record.

If re-set billing time miss the last billing time, the meter will immediately record billing;
 If power off during the billing time, the meter will immediately record billing after power recover.

2.- Billing period is designed for automatic closed loop, when Segment-X time-point equal segment-1 time-point, the remained segment setting will be ignoring by meter.

6.6.- Detail information of menu “Contact Us”

This menu will display the device version and real-time clock information.



7.- PULSE OUTPUT

APM-96Q provides 1-2 pulse output for the total active energy & total reactive energy.

The host / PLC / DI module can cumulative the data of both the active and reactive power energy sent by the pulse from opt coupler relay.

1). Electrical specification: voltage $VCC \leq 48V$, $I_z \leq 50mA$.

2). Pulse: 5000 imp / kWh, pulse up to 80ms.

This means: When the device detects 1 kWh, the port will generate 5000 pulse.

Note: 1 kWh energy is for *secondary side energy data*, if there have PT and CT accessed; primary side energy data is "1 kWh \times PT ratio \times CT ratio".

Voltage (V)	Current (A)	Pulse constant (imp / kWh)
380 or 220	5	5000
	1	20000
100	5	20000
	1	80000

Example: In measure time "T", the received total pulse is "N",
 Primary side input of voltage is 10Kv,
 Primary side input of current is 400A.
 Secondary side measurement range is 100V and 5A.

In the time "T", energy accumulated is: $N / 20000 \times 100 \times 80$

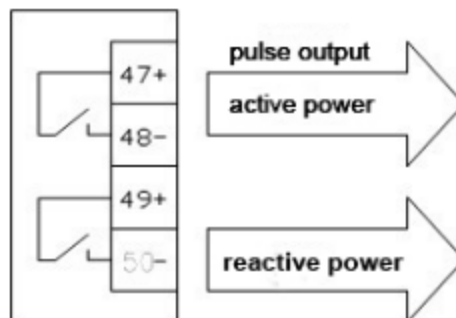

8.- COMMUNICATION INTERFACE

8.1.- Connection for RS485 BUS

The composition of the RS-485 cabling must be carried out with a meshed screen cable (minimum 3 wire), diameter of not less than 0.5mm², with a maximum distance of 1,200 m between the APM-96Q and the master unit. This Bus may connect a maximum of 32pcs APM-96Q...

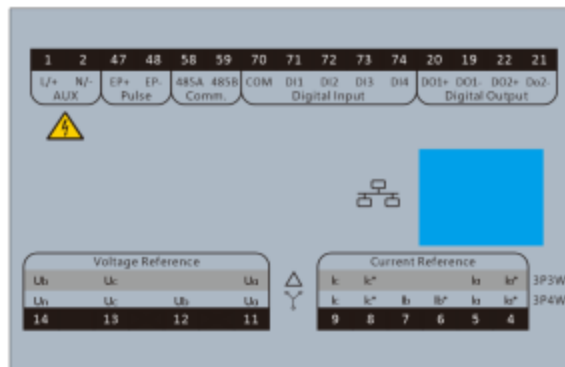

Notes:

- For communication with the master unit, user can choose RS-485 to RS-232 converter or RS485 to USB adapter to use.
- For expand the number of devices in the communication network, a signal repeater can be used
- Full range of APM series meter RS485 PIN number is 58,59.
- Due to product modifications or special requirements, the interface pin place may be change. For details, please refer to product label on the rear side.

8.2.- MODBUS © protocol

Modbus RTU Frame Format:

Address code	1 BYTE	<i>Slave device address 1-247</i>
Function code	1 BYTE	<i>Indicates the function codes like read coils / inputs</i>
Data code	4 BYTE	<i>Starting address, high byte Starting address, low byte Number of registers, high byte Number of registers, low byte</i>
Error Check code	2 BYTE	<i>Cyclical Redundancy Check (CRC)</i>

MODBUS FUNCTIONS:

Code	Meaning	Description
FUNCTION 01	Read coil status	<i>Only valid when equipped DO port</i>
FUNCTION 02	Read input status	<i>Only valid when equipped DI port</i>
FUNCTION 03	Reading of n words	<i>This function permits to read all the electrical parameters of the device.</i>
FUNCTION 05	Force single coil	<i>When DO in remote control mode can work</i>
FUNCTION 06	Preset single holding registers	<i>There is an upper limit for writing, please be sure to check the upper limit of the host computer to avoid exhausting the life of the storage machine.</i>

Note: Float data follow **IEEE754**, float low bit first, high bit next. **(CD AB)**

8.3.- Register map

8.3.1.- Basic power data- primary side

Register	Data	Byte mode		Instruction
0x00	Ua	float	2	Phase to line voltage, Unit: V
0x02	Ub	float	2	
0x04	Uc	float	2	
0x06	Uab	float	2	Phase to phase voltage, Unit: V
0x08	Ubc	float	2	
0x0a	Uca	float	2	
0x0c	Ia	float	2	Three phase current, Unit: A
0x0e	Ib	float	2	
0x10	Ic	float	2	
0x12	Pa	float	2	Total and split phase active power, Unit: kW
0x14	Pb	float	2	
0x16	Pc	float	2	
0x18	$P\Sigma$	float	2	Total and split phase reactive power, Unit: kVar
0x1a	Qa	float	2	
0x1c	Qb	float	2	
0x1e	Qc	float	2	Total and split apparent power, Unit: kVA
0x20	$Q\Sigma$	float	2	
0x22	Sa	float	2	
0x24	Sb	float	2	Total and split power factor, 0~1.000
0x26	Sc	float	2	
0x28	$S\Sigma$	float	2	
0x2a	PFa	float	2	Frequency, Unit:0.01Hz
0x2c	PFb	float	2	
0x2e	PFc	float	2	
0x30	$PF\Sigma$	float	2	Positive active energy, Unit: kWh
0x32	FR	float	2	
0x34	Ep+	float	2	Negative active energy, Unit: kWh
0x36	Ep-	float	2	
0x38	Eq+	float	2	Inductive reactive power, Unit: kVarh
0x3a	Eq-	float	2	
0x3c	ES	float	2	Capacitive reactive power
0x3e	EpA+	float	2	
0x40	EpA-	float	2	Total apparent energy, unit: VAh
0x42	EqA+	float	2	
0x44	EqA-	float	2	A phase positive active energy, unit: kWh
				A phase negative active energy
				A phase inductive reactive energy, unit: kVarh
				A phase capacitive reactive energy

0x46	ESA	float	2	A phase apparent energy, unit VAh
0x48	EpB+	float	2	B phase positive active energy, unit: kWh
0x4A	EpB-	float	2	B phase negative active energy
0x4C	EqB+	float	2	B phase inductive reactive energy, unit: kVarh
0x4E	EqB-	float	2	B phase capacitive reactive energy
0x50	ESB	float	2	B phase apparent energy, unit: VAh
0x52	EpC+	float	2	C phase positive active energy, unit: kWh
0x54	EpC-	float	2	C phase negative active energy
0x56	EqC+	float	2	C phase inductive reactive energy, unit: kVarh
0x58	EqC-	float	2	C phase capacitive reactive energy
0x5A	ESC	float	2	C phase apparent energy, unit: VAh
0x5C	Io	float	2	Real-time measurement zero-sequence current data, unit: A (Reserved function)
0x64	FUa	float	2	A, B, C phase fundamental phase voltage
0x66	FUb	float	2	
0x68	FUc	float	2	
0x6A	FUab	float	2	A, B, C phase fundamental line voltage
0x6C	FUbc	float	2	
0x6E	FUca	float	2	
0x70	Fla	float	2	A, B, C phase fundamental current
0x72	Flb	float	2	
0x74	Flc	float	2	

8.3.2.- Basic power data- secondary Side

Register	Data	Byte		Instruction
0x100	Ua	int	1	Phase to line voltage, Unit: 0.1V
0x101	Ub	int	1	
0x102	Uc	int	1	
0x103	Uab	int	1	Phase to phase voltage, Unit: 0.1V
0x104	Ubc	int	1	
0x105	Uca	int	1	
0x106	Ia	int	1	Three phase current, Unit: 0.001A
0x107	Ib	int	1	
0x108	Ic	int	1	
0x109	Pa	int	1	Total and split phase active power, Unit: kW
0x10a	Pb	int	1	
0x10b	Pc	int	1	
0x10c	$P\Sigma$	int	1	
0x10d	Qa	int	1	Total and split phase reactive power, Unit: kVar
0x10e	Qb	int	1	
0x10f	Qc	int	1	
0x110	$Q\Sigma$	int	1	
0x111	Sa	int	1	Total and split apparent power, Unit: kVA
0x112	Sb	int	1	
0x113	Sc	int	1	
0x114	$S\Sigma$	int	1	
0x115	PFa	int	1	Total and split power factor, 0~1.000
0x116	PFb	int	1	
0x117	PFc	int	1	
0x118	$PF\Sigma$	int	1	
0x119	FR	int	1	Frequency, Unit:0.01Hz
0x11a	Ep+	Int 32	2	Positive active energy, Unit: Wh
0x11c	Ep-	Int 32	2	Negative active energy, Unit: Wh
0x11e	Eq+	Int 32	2	Inductive reactive power, Unit:Varh
0x120	Eq-	Int 32	2	Capacitive reactive power
0x122	ES	int	2	Total apparent energy, unit: VAh
0x124	EpA+	int	2	A phase positive active energy, unit: kWh
0x126	EpA-	int	2	A phase negative active energy
0x128	EqA+	int	2	A phase inductive reactive energy, unit: kVarh
0x12A	EqA-	int	2	A phase capacitive reactive energy
0x12C	ESA	int	2	A phase total apparent energy, unit VAh

0x12E	EpB+	int	2	B phase positive active energy, unit: kWh
0x130	EpB-	int	2	B phase negative active energy
0x132	EqB+	int	2	B phase inductive reactive energy, unit: kVarh
0x134	EqB-	int	2	B phase capacitive reactive energy
0x136	ESB	int	2	B phase total apparent energy, unit: VAh
0x138	EpC+	int	2	C phase positive active energy, unit: kWh
0x13A	EpC-	int	2	C phase negative active energy
0x13C	EqC+	int	2	C phase inductive reactive energy, unit: kVarh
0x13E	EqC-	int	2	C phase capacitive reactive energy
0x140	ESC	int	2	C phase total apparent energy, unit: VAh
0x142	Io	int	1	Real-time measurement zero-sequence current data, unit: 0.001A (Reserved function)
0x143	Ang_Ua	int	1	A phase voltage phase angle, unit: 0.1 degree
0x144	Ang_Ub	int	1	B phase voltage phase angle
0x145	Ang_Uc	int	1	C phase voltage phase angle
0x146	Ang_Ia	int	1	A phase current phase angle
0x147	Ang_Ib	int	1	B phase current phase angle
0x148	Ang_Ic	int	1	C phase current phase angle
0x150	Ua	int	1	A, B, C phase fundamental phase voltage, unit 0.1V
0x151	Ub	int	1	
0x152	Uc	int	1	
0x153	Uab	int	1	A, B, C phase fundamental line voltage, unit 0.1V
0x154	Ubc	int	1	
0x155	Uca	int	1	
0x156	Ia	int	1	A, B, C phase fundamental current, unit 0.001A
0x157	Ib	int	1	
0x158	Ic	int	1	

8.3.3.- Meter status data

Register	Data	Byte mode		Instruction
0x200	DO	int	1	Digital output: Bit 0~1 show channel 1 and channel 2 status 0 for open, 1 for closed
0x201	DI	int	1	Digital input: Bit 0~3 show channel 1 to channel 4 status 0 for open, 1 for closed
0x202	DZ	int	1	Alarm status Bit 0~4 show channel 1- channel 5 alarm status
0x20A	RTC. year	int	1	Internal RTC real time clock: Year - Month - Date - Hour - Minutes – Second - Week
0x20B	RTC. month	int	1	
0x20C	RTC. date	int	1	
0x20D	RTC. hour	int	1	
0x20E	RTC. minute	int	1	
0x20F	RTC. second	int	1	
0x210	RTC. week	int	1	

8.3.4.- Advanced electrical parameter

Register	Data	Byte mode		Instruction
0x300	Pd	float	2	Present active power demand, Unit: W
0x302	Qd	float	2	Present reactive power demand, Unit: var
0x304	Sd	float	2	Present apparent power demand, Unit: VA
0x306	Pd_M0	float	2	Maximum active power demand in present month
0x308	Qd_M0	float	2	Maximum reactive power demand in present month
0x30a	Sd_M0	float	2	Maximum apparent power demand in present month
0x30c	Pd_M1	float	2	Maximum active power demand in last month
0x30e	Qd_M1	float	2	Maximum reactive power demand in last month
0x310	Sd_M1	float	2	Maximum apparent power demand in last month
0x312	Pd_M2	float	2	Maximum active power demand in month before last month
0x314	Qd_M2	float	2	Maximum reactive power demand in month before last month
0x316	Sd_M2	float	2	Maximum apparent power demand in month before last month
0x318-0x31F	/	float	2	Reserved
0x320	U1	float	2	Positive sequence voltage in primary side
0x322	U2	float	2	Negative sequence voltage in primary side
0x324	U0	float	2	Zero sequence voltage in primary side
0x326	I1	float	2	Positive sequence current in primary side
0x328	I2	float	2	Negative sequence current in primary side
0x32A	I0	float	2	Zero sequence current in primary side
0x32C	εU	float	2	Voltage unbalance, $\varepsilon U = (U2 / U1)\%$
0x32E	εI	float	2	Current unbalance, $\varepsilon U = (I2 / I1)\%$
0x330	δU_a	float	2	A phase voltage deviation
0x332	δU_b	float	2	B phase voltage deviation
0x334	δU_c	float	2	C phase voltage deviation

0x336	δF	float	2	Frequency deviation
0x338		float	2	A phase voltage short-term flicker value (latest 10 minutes)
0x33A		float	2	B phase voltage short-term flicker value (latest 10 minutes)
0x33C		float	2	C phase voltage short-term flicker value (latest 10 minutes)
0x33E		float	2	A phase voltage long-term flicker value (latest 2 hours)
0x340		float	2	B phase voltage long-term flicker value (latest 2 hours)
0x342		float	2	C phase voltage long-term flicker value (latest 2 hours)
0x344		float	2	A phase voltage fluctuation max value (latest 10 minutes)
0x346		float	2	B phase voltage fluctuation max value (latest 10 minutes)
0x348		float	2	C phase voltage fluctuation max value (latest 10 minutes)
0x34A		int	1	Timestamp of short-term flicker & voltage fluctuation update (Year)
0x34B		int	1	Timestamp of short-term flicker & voltage fluctuation update (Month)
0x34C		int	1	Timestamp of short-term flicker & voltage fluctuation update (Date)
0x34D		int	1	Timestamp of short-term flicker & voltage fluctuation update (Hour)
0x34E		int	1	Timestamp of short-term flicker & voltage fluctuation update (Minute)
0x34F		int	1	Timestamp of short-term flicker & voltage fluctuation update (Second)
0x350		float	2	A phase latest voltage sag min value, unit: V
0x352		float	2	B phase latest voltage sag min value, uunit: V
0x354		float	2	C phase latest voltage sag min value, unit: V
0x356		float	2	A phase latest voltage sag duration time, unit ms
0x358		float	2	B phase latest voltage sag duration time, unit ms
0x35A		float	2	C phase latest voltage sag duration time, unit ms
0x35C		int	1	Timestamp of A phase latest voltage sag end time (Year)
0x35D		int	1	Timestamp of A phase latest voltage sag end time (Month)
0x35E		int	1	Timestamp of A phase latest voltage sag end time (Date)
0x35F		int	1	Timestamp of A phase latest voltage sag end time (Hour)

0x360		int	1	Timestamp of A phase latest voltage sag end time (Minute)
0x361		int	1	Timestamp of A phase latest voltage sag end time (Second)
0x362-0x367		int	1	Timestamp of B phase latest voltage sag end time (Year- Month- Date- Hour- Minute- Second)
0x368-0x36d		int	1	Timestamp of C phase latest voltage sag end time (Year- Month- Date- Hour- Minute- Second)
0x36E		float	2	A phase latest voltage swell max value, unit: V
0x370		float	2	B phase latest voltage swell max value, unit: V
0x372		float	2	C phase latest voltage swell max value, unit: V
0x374		float	2	A phase latest voltage swell duration time, unit ms
0x376		float	2	B phase latest voltage swell duration time, unit ms
0x378		float	2	C phase latest voltage swell duration time, unit ms
0x37A		int	1	Timestamp of A phase latest voltage swell end time (Year)
0x37B		int	1	Timestamp of A phase latest voltage swell end time (Month)
0x37C		int	1	Timestamp of A phase latest voltage swell end time (Date)
0x37D		int	1	Timestamp of A phase latest voltage swell end time (Hour)
0x37E		int	1	Timestamp of A phase latest voltage swell end time (Minute)
0x37F		int	1	Timestamp of A phase latest voltage swell end time (Second)
0x380-0x385		int	1	Timestamp of B phase latest voltage sag swell time (Year- Month- Date- Hour- Minute- Second)
0x386-0x38B		int	1	Timestamp of C phase latest voltage sag swell time (Year- Month- Date- Hour- Minute- Second)

8.3.5.-Tou/ Multi- tariffs ratio data

Register	Data	Byte mode		Instruction
0x400	Sum	long	2	Total cumulative energy of M0+M1+M2
0x402	Sum _T1	long	2	T1-T4 cumulative Energy record
0x404	Sum _T2	long	2	
0x406	Sum _T3	long	2	
0x408	Sum _T4	long	2	
0x40a	M0_Sum	long	2	Total energy of this month
0x40c	M0_T1	long	2	T1-T4 Energy record of present month
0x40e	M0_T2	long	2	
0x410	M0_T3	long	2	
0x412	M0_T4	long	2	
0x414	M1_Sum	long	2	Total energy of last month
0x416	M1_T1	long	2	T1-T4 Energy record of last month
0x418	M1_T2	long	2	
0x41a	M1_T3	long	2	
0x41c	M1_T4	long	2	
0x41e	M2_Sum	long	2	Total energy of the month before last month
0x420	M2_T1	long	2	T1-T4 Energy record of the month before last month
0x422	M2_T2	long	2	
0x424	M2_T3	long	2	
0x426	M2_T4	long	2	

Note:

To further clarify, take an example:

Assuming this month is March 2025,

M0 (this month): refers to March 2025;

M1 (last month): refers to February 2025;

M2 (the month before last month): refers to data from January 2025.

8.3.6.- THD and individual harmonic (max 127th times)

Register	Data	Byte mode		Instruction
0x500	THDUa	int	1	A-phase voltage THD
0x501	THDUB	int	1	B-phase voltage THD
0x502	THDUC	int	1	C-phase voltage THD
0x503	THDIA	int	1	A-phase current THD
0x504	THDIB	int	1	B-phase current THD
0x505	THDIC	int	1	C-phase current THD
0x508-0x545	HUa	int	62	Three phase voltage individual harmonic 2 to 63 rd
0x548-0x585	HUB	int	62	
0x588-0x5c5	HUC	int	62	
0x5c8-0x605	HIA	int	62	Three phase current individual harmonic 2 to 63 rd
0x608-0x645	HIB	int	62	
0x648-0x685	HIC	int	62	
0x688	TOHDUa	int	1	Three phase voltage total odd harmonic distortion, unit 0.1%
0x689	TOHDUB	int	1	
0x68a	TOHDUC	int	1	
0x68b	TEHDUa	int	1	Three phase voltage total even harmonic distortion, unit 0.1%
0x68c	TEHDUB	int	1	
0x68d	TEHDUC	int	1	
0x68e	THFFUa	int	1	Three phase voltage telephone harmonic form factor, unit 0.1%
0x68f	THFFUb	int	1	
0x690	THFFUc	int	1	
0x691	CFUa	int	1	Three phase voltage crest factor, unit 0.001
0x692	CFUb	int	1	
0x693	CFUc	int	1	
0x694	TOHDIa	int	1	A phase current total odd harmonic distortion, unit 0.1%
0x695	TOHDIB	int	1	
0x696	TOHDIC	int	1	
0x697	TEHDIa	int	1	Three phase current total even harmonic distortion, unit 0.1%
0x698	TEHDIB	int	1	
0x699	TEHDIC	int	1	

0x69a	KFIa	int	1	Three phase current K factor, unit 0.01
0x69b	KFIb	int	1	
0x69c	KFIc	int	1	
0xC00-0xC3F	HUa	int	64	Three phase voltage individual harmonic 64 to 127 th
0xC40-0xC7F	HUb	int	64	
0xC80-0xCBf	HUc	int	64	
0xCC0-0xCFF	HIa	int	64	Three phase current individual harmonic 64 to 127 th
0xD00-0xD3F	HIb	int	64	
0xD40-0xD7F	HIc	int	64	
0xE00-0xE3F	IHUa	int	64	Three phase voltage 0.5, 1.5, ..., 63.5th interharmonic components, unit: 0.1%
0xE40-0xE7F	IHUb	int	64	
0xE80-0xEBF	IHUc	int	64	
0xEC0-0xEFF	IHIa	int	64	Three phase current 0.5, 1.5, ..., 63.5th interharmonic components, unit: 0.1%
0xF00-0xF3F	IHIb	int	64	
0xF40-0xF7F	IHIc	int	64	

8.3.7.- SOE record

Register	Data	Byte mode		Instruction
0x700-0x731	I/O event 10 lists	int	5	Byte 0: Fault type Byte 1: Fault event Byte 2,3: Fault value Byte 4: Fault time: Year Byte 5: Fault time: Month Byte 6: Fault Time: Date Byte 7: Fault time: Time Byte 8: Fault time: Minute Byte 9: Fault time: Seconds
0x732-0x7F9	Alarm event 40 lists			

Byte 0	Byte 1
1:DI1 Closed 2:DI2 Closed 3:DI3 Closed 4:DI4 Closed 21:DI1 Opened 22:DI2 Opened 23:DI3 Opened 24:DI4 Opened 51: Alarm_1 tripped 52: Alarm_2 tripped 53: Alarm_3 tripped 54: Alarm_4 tripped 55: Alarm_5 tripped 61: Alarm_1 released 62: Alarm_2 released 63: Alarm_3 released 64: Alarm_4 released 65: Alarm_5 released 101:DO1 Closed 102:DO2 Closed 121:DO1 Opened 122:DO2 Opened	0: Remote control 1: DZ Alarm_1 2: DZ Alarm_2 3: DZ Alarm_3 4: DZ Alarm_4 5: DZ Alarm_5 6: Manually close DO 7: Manually open DO 100: Manually turn off DZ when tripped 101:UA upper alarm 102:UB upper alarm 103:UC upper alarm 104:UAB upper alarm 105:UBC upper alarm 106:UCA upper alarm 107:UA/UB/UC upper alarm 108:IA upper alarm 109:IB upper alarm 110:IC upper alarm 111:IA/IB/IC3 upper alarm 112:PA upper alarm 113:PB upper alarm 114:PC upper alarm 115:total active power upper alarm 116:QA upper alarm 117:QB upper alarm 118:QC upper alarm 119:total reactive power upper alarm 120:SA upper alarm 121:SB upper alarm 122:SC upper alarm 123:total apparent power upper alarm 124:total power factor upper alarm 125:frequency upper alarm 126:DI1 close alarm 127:DI2 close alarm 128:DI3 close alarm 129:DI4 close alarm 130:DI5 close alarm 131:DI6 close alarm 132:UA lower alarm 133:UB lower alarm 134:UC lower alarm 135:UAB lower alarm 136:UBC lower alarm 137:UCA lower alarm 138:UA/UB/UC lower alarm 139:IA lower alarm 140:IB lower alarm 141:IC lower alarm 142:IA/IB/IC3 lower alarm 143:PA lower alarm 144:PB lower alarm 145:PC lower alarm 146:total active power lower alarm 147:QA lower alarm 148:QB lower alarm 149:QC lower alarm 150:total reactive power lower alarm 151:SA lower alarm 152:SB lower alarm 153:SC lower alarm 154:total apparent power lower alarm 155:total power factor lower alarm 156:frequency lower alarm 157:DI1 open alarm 158:DI2 open alarm 159:DI3 open alarm 160:DI4 open alarm 161:DI5 open alarm 162:DI6 open alarm

8.3.8.- Waveform capture record- secondary side

Register	Data	Byte mode		Instruction
0x920	Register waveform record number	int	1	Input range: 1–30 For example, when set to 3, means that registers 0x2AF8–0xD59E temporarily store the 3rd waveform record.
0x2AF8 – 0x2B77	Ua1-Ua128	int	1	Three-phase voltage waveform data from point 1 to 128, unit 0.1V
0x2B78 – 0x2BF7	Ub1-Ub128	int	1	
0x2BF8 – 0x2C77	Uc1-Uc128	int	1	
0x2C78 – 0x2CF7	Ia1-Ia128	int	1	Three-phase current waveform data from point 1 to 128, unit 0.001A
0x2CF8 – 0x2D77	Ib1-Ib128	int	1	
0x2D78 – 0x2DF7	Ic1-Ic128	int	1	
0x2DF8 – 0x30F7		int	1	Three-phase voltage/ current point 129-256 data
0x30F8 – 0x33F7		int	1	Three-phase voltage/ current point 257-384 data
...
0xD278 – 0xD2F7		int	1	Three-phase voltage/ current point 7041-7168 data
0xD2F8 – 0xD317	Ua	int	1	Three-phase voltage point 7169-7200 data, unit 0.1V (Note that the address here is not continuous)
0xD378 – 0xD397	Ub	int	1	
0xD3F8 – 0xD417	Uc	int	1	
0xD478 – 0xD497	Ia	int	1	Three-phase current point 7169-7200 data, unit 0.001A (Note that the address here is not continuous)
0xD4F8 – 0xD517	Ib	int	1	
0xD578 – 0xD597	Ic	int	1	
0xD598	Type	int	1	Trigger recording reason 1: Alarm-1 2: Alarm-2 3: Alarm-3 ...
0xD599	Year	int	1	Trigger recording time
0xD59A	Month	int	1	
0xD59B	Date	int	1	
0xD59C	Hour	int	1	
0xD59D	Minute	int	1	
0xD59E	Second	int	1	

Command example:

If device communication address is 1, read the data of UA point 1~18 in the second recording, a total of 18 registers:

Step 1:

Host inquiry: 01 06 09 20 00 02 0A 5D

Slave response: 01 06 09 20 00 02 0A 5D

Step 2:

Host inquiry: 01 03 2A F8 00 12 D3 25

Slave response: 01 03 24 09 20 09 8A 07 A5 06 48 07 7F 09 35 08 94 06 67 05 DA 07 94 08 94 07 08 05 08 05 67 07 37 07 86 05 BA 03 CE EC F4

8.3.9.- Load record- secondary side (optional)

Register	Data	Byte mode		Instruction
0xA00	Recording time 1	int	1	Bit8-15: Month Bit0-7: Date
0xA01	Recording time 2	int	1	Bit8-15: Hour Bit0-7: Minute
0xA02	Ua	int	1	Three-phase voltage average value, unit 0.1V
0xA03	Ub	int	1	
0xA04	Uc	int	1	
0xA05	Ia	int	1	Three-phase current average value, unit 0.001A
0xA06	Ib	int	1	
0xA07	Ic	int	1	
0xA08	$P\Sigma$	int	1	Total active power average value, unit W
0xA09	$Q\Sigma$	int	1	Total reactive power average value, unit var
0xA0A	Ep+1	int	1	Positive active energy high 16 bits, unit 0.01kWh
0xA0B	Ep+2	int	1	Positive active energy low 16 bits, unit 0.01kWh
0xA0C	Eq+1	int	2	Positive reactive energy high 16 bits, unit 0.01kvarh
0xA0D	Eq+2	int	2	Positive reactive energy low 16 bits, unit 0.01kvarh
0xA0E	$S\Sigma$	int	1	Total apparent power average value, unit VA

Note:

The index number is read from 0x930, and the recording interval is 15 minutes. If 0xEEEE is read, it means it is empty.

8.3.10.- Configuration menu (Function 03 to Read & Function 06 to Write)

Register	Data	Byte mode		Instruction
0x20A	RTC. year	int	1	Internal RTC real-time time: year-month-date-hour-minute-second-week
0x20B	RTC. month	int	1	
0x20C	RTC. date	int	1	
0x20D	RTC. hour	int	1	
0x20E	RTC. minute	int	1	
0x20F	RTC. second	int	1	
0x210	RTC. week	int	1	
0x900	Line	int	1	Wiring method: 0: 3-phase 4-line 1: 3-phase 3- line 2CT 2: 3-phase 3- line 3CT
0x901	U.SCL	int	1	Voltage range 0:100V; 1:380V
0x902	I.SCL	int	1	Current range 0:1A; 1:5A
0x903	PT	int	1	Voltage ratio: range 1-9999 (The direct access type is 1 and cannot be changed).
0x904	CT	int	1	Current ratio: range 1-9999 (The direct access type is 1 and cannot be changed).
0x905	RS485 address	int	1	1-247
0x906	Baud rate	int	1	0: 2400 1: 4800 2: 9600 3: 19200
0x907	Data format	int	1	0: n.8.1 1: o.8.1 2: e.8.1 3: n.8.2
0x920	Register waveform record number	int	1	Input range: 1–30 For example, when set to 3, means that registers 11000–54686 temporarily store the 3rd waveform record.
0x930	Load curved record index number	int	1	The historical index number corresponds to 0xA00. Read data: range 1-35040. When it is 1, it means reading the most recently recorded load data. When the host does not change this parameter for more than 300 seconds, it automatically restores the default value 1.

Notes:

1. Not all data above can be read by RS485
2. Whether the data can be read out or not depends on your multi-function meter model, please refer to the corresponding product manual before build your software.
3. Some software have different definitions of the start bit of register address, there will be offset, please add 1 for the right address. To get more info, please contact technical support tech@cqbluejay.com

8.4.- Example

Host inquiry slave device

Addr.	Func.	Data Address (high)	Data Address (low)	Data Number (high)	Data number (low)	CRC16 (low)	CRC16 (high)
0CH	03H	00H	00H	00H	06H	C4H	D5H

PC users are asked to upload UA, UB, UC, IA, IB, IC

Slave device answer

Addr.	Func.	Byte count	Data1 high	Data1 low	Data2 high	Data2 low	Data3 high	Data3 low
0CH	03H	0CH	03H	E8H	03H	E9H	03H	E8H
Data4 high	Data4 low	Data5 high	Data5 low	Data6 high	Data6 low	CRC16 low	CRC16 high	
13H	84H	13H	88H	13H	8AH	A6H	D6H	

Show the data:

UA=3E8H (100.0)

UB=3E9H (100.1)

UC=3E7H (99.9)

IA=1384H (4.996)

IB=1388H (5.000)

IC=138AH (5.002)

Notes:

1. Blue Jay disables the 06 function in default setting. If users want to activated the write command, please check the host device program to avoid the meaningless write operation, which may reduce the register working life.
2. When the write is unsuccessful, no return data from the slave device. In this case, please re-send write inquiry

9.- SAFETY CONSIDERATIONS



3-67628702

y.com

ilding 2, No.88, Jianxin East Road, Chongqing, 400020, China

Email: tech@cqbluejay.com

All installation specification described at the previous chapters named: **INSTALLATION AND STARTUP, INSTALLATION MODES and SPECIFICATIONS.**

Please note that with the instrument powered on, the terminals could be dangerous to touching and cover opening actions or elements removal may allow accessing dangerous parts. This instrument is factory-shipped at proper operation condition.

- ◆ The device must have a professional installation and maintenance.
- ◆ Any operation of the device, you must cut off the input signal and power.

10.- MAINTENANCE

The APM-96Q meter does not require any special maintenance. No adjustment, maintenance or repairing action should be done when the instrument is open and powered on, should those actions are essential, high-qualified operators must perform them.

Before any adjustment, replacement, maintenance or repairing operation is carried out, the instrument must be disconnected from any power supply source.

When any protection failure is suspected to exist, the instrument must be immediately put out of service. The instrument's design allows a quick replacement in case of any failure.

11.- TECHNICAL SERVICE

FAQ's

- 1.- Once cabled and connected is seen to give a correct voltage and current reading, but shows negative values for active power (generation).

This is an error with the cabling for the current transformer secondary; the direction of the transformer current has to be respected as shown in the connection diagram. The current transformers have a two face primary; the current must pass from P1 to P2 giving the result in secondary (S1 and S2) of 5 amps.

The error stems from:

- a). The current transformers have been incorrectly installed. As a result, it gives the direction of the current as passing from P2 to P1; to resolve this problem, the current transformer does not have to be dismantled and installed again, but the transformer secondary (S1 and S2) just has to be inverted.
 - b). The connection of the current secondary in the current transformers have been incorrectly connected; to resolve this problem just connect the S1 transformer secondary to the S1 on the meter and the S2 on the current transformer to the S2 on the meter.
- 2.- Once cabled and connected, is seen to give an incoherent Power factor and Cos Φ reading (-0.01 or similar).

This is again a current transformer and voltage phase connection error phase A, must correspond to the current transformer installed in phase A; phase B, must correspond to the current transformer installed in phase B; and phase C, must correspond to the current transformer installed in phase C.

This connection terminal is clearly shown on the area side of the device.

- 3.- The measuring voltage and is displaying the secondary voltage (for example 110 volts). Ensure that the voltage Transformer ratio has been correctly set (Please refer to voltage PT ratio setting section in chapter **SETUP PROCEDURE**).
- 4.- Device does not correctly display the current reading. It shows values varying between 0 to 5 amps of current. Ensure that the Current Transformer ratio has been correctly set; (Please refer to current CT ratio setting section in chapter **SETUP PROCEDURE**).

Calculation formula of electrical parameter

Formula	Parameter
$U = \sqrt{\frac{1}{N} \sum_{n=0}^N u_n^2} \quad n = 0, 1, 2, \dots, N$	Voltage RMS value
$I = \sqrt{\frac{1}{N} \sum_{n=0}^N i_n^2} \quad n = 0, 1, 2, \dots, N$	Current RMS value
$P = \frac{1}{N} \sum_{n=1}^N (i_{an} u_{an} + i_{bn} u_{bn} + i_{cn} u_{cn})$	Total active power cycle average
$P_s = UI$	Single-phase apparent power cycle average
$\cos \theta = \frac{P_p}{P_s}$	Power factor
$P_q = \sqrt{P_s^2 - P_p^2}$	Reactive power (Pq is positive and the direction cannot be determined; P algorithm can be used to shift the voltage component by 90°)
$W = \int P * dt$	Electric energy

Note: In above formula, N for sampling points in one AC wave, In standard APM-96Q, the N=128

For any inquiry about the instrument performance or any failure, contact to Blue Jay's technical service.

Blue Jay - After-sales service

E-mail: tech@cqbluejay.com

Tel: +0086-023-67628702

www.cqbluejay.com

Add: 1802, Building 2, No.88, Jianxin East Road, Chongqing, 400020, China

[Email: tech@cqbluejay.com](mailto:tech@cqbluejay.com)