

# DH-C16 Intelligent Compressor Dehumidifier

## User Manual



**Version: 1.10**

**Revision: 2026.03**

## Read me

**When you use DH-C16 Intelligent compressor dehumidifier, be sure to read this user manual carefully, and be able to fully understand the implications, the correct guidance of operations in accordance with user manual, which will help you make better use of DH-C16 Intelligent compressor dehumidifier and help to solve the various problems on the site.**

1. Always keep safe distance between the high voltage part and the instrument, probe and operator.
2. Measurements must not be taken when thunderstorms are nearby.
3. Do not operate the instrument or accessories in explosive atmospheres.
4. After the battery alarm of the instrument, please turn off the power to charge.
5. Do not open the instrument without permission, this will affect the warranty of the product. The factory is not responsible for self-disassembly.
6. When the instrument is transported, it should avoid rain erosion and prevent collision and falling.
7. When storing and keeping the instrument, attention should be paid to the ambient temperature and humidity, and it should be protected from dust, moisture, shock, acid, and corrosive gas.



- **Please read this user manual carefully**
- **Please save this document**

## Directory

<b>1.- SUMMARIZE .....</b>	<b>- 1 -</b>
<b>2.- FUNCTION INTRODUCTION .....</b>	<b>- 2 -</b>
2.1.- DEHUMIDIFICATION FUNCTION .....	- 2 -
2.2.- DEHUMIDIFICATION PRINCIPLE .....	- 3 -
2.3.- HEATING FUNCTION (OPTIONAL) .....	- 3 -
2.4.- RS485 COMMUNICATION FUNCTION (OPTIONAL) .....	- 3 -
2.5.- ALARM DIGITAL OUTPUT (OPTIONAL) .....	- 4 -
<b>3.- TECHNICAL SPECIFICATION .....</b>	<b>- 5 -</b>
<b>4.- INSTALLATION AND START-UP .....</b>	<b>- 7 -</b>
4.1.- BASE-MOUNTED INSTALLATION DIMENSION (UNIT: MM) .....	- 7 -
4.2.- CONNECTION TERMINAL AND WIRING METHOD .....	- 8 -
4.3.- KEY DESCRIPTION .....	- 9 -
<b>5.- COMMUNICATION INTERFACE .....</b>	<b>- 10 -</b>
5.1.- MODBUS © PROTOCOL .....	- 10 -
5.2.- COMMAND SAMPLES .....	- 11 -
5.3.- REGISTER MAP .....	- 15 -
<b>6.- SAFETY CONSIDERATIONS .....</b>	<b>- 16 -</b>
<b>7.- TECHNICAL SERVICE .....</b>	<b>- 16 -</b>

## 1.- SUMMARIZE

DH-C16 Intelligent compressor dehumidifier uses compressor refrigeration technology to make the moisture air inside the electric box condense into water on the surface of the condensation plate of the dehumidifier and then discharge it out of the cabinet, quickly reducing the humidity inside the cabinet.

DH-C16 Intelligent compressor dehumidifier is equipped with an intelligent control module and adopts anti-interference technology. The double-row digital tube displays the measured value and the set value at the same time, and alternately displays the current temperature and humidity, and realizes the automatic control function of humidity.

### FEATURES

- 16L/day dehumidification capacity;
- Built-in temperature & humidity sensor;
- Compressor refrigeration dehumidification;
- LCD display for real-time monitoring;
- Auto defrost control function;
- RS485/ Modbus-RTU communication;
- One channel fault alarm relay output;
- One channel heater control relay output;

### APPLICATIONS

- Power substation equipment rooms;
- Relay protection & control panels;
- Switchgear & transformer chambers;
- Data centers & telecom center;
- Distribution & control cabinets;
- Relay testing & maintenance rooms;
- Power Control & monitoring centers;

## 2.- FUNCTION INTRODUCTION

### 2.1.- Dehumidification function

After the device is powered on, it will be automatically controlled according to the actual humidity setting value. When it is higher than the setting value, it is in the dehumidification stage, and when it is lower than [setting value-hysteresis value], it is in the stop stage.

#### **Test step:**

1. In first start, when the humidity is greater than the dehumidification upper limit, the fan and compressor will start synchronously (so please do not frequently power off and on when there is a power outage);
2. When the humidity is lower than the lower limit, the dehumidification stops, and the fan and compressor stop synchronously;
3. When the measured humidity value is again greater than the upper limit or the second time manually started dehumidifier. to protect the compressor and the starting capacitor working life, the compressor will lag the fan for 3 minutes each time before starting;
4. During the dehumidification process, the dehumidification runs for more than 20 minutes and the condenser temperature is lower than the setting value (for example, -1 degree) for more than 5 minutes, and then enters the defrost mode;
5. When the condenser temperature is greater than 3 degrees or the temperature rises by more than 14 degrees, set the defrost temperature minutes, release the defrost mode.
6. External heater working principle: when the ambient temperature is lower than the set temperature, start the external heater, and stop heating when the temperature is higher than the set temperature plus the hysteresis;
7. When the ambient temperature and humidity sensor fails, the dehumidifier does not work.

## 2.2.- Dehumidification principle

The intelligent compressor dehumidifiers operate based on the vapor-compression refrigeration principle. Humid air is drawn into the unit and passes through the evaporator, where moisture condenses into water and is discharged through the drainage tube. The air reheated by the condenser and released back into the environment, enabling continuous dehumidification. The refrigerant circulates through the compressor, condenser, expansion device, and evaporator to complete the refrigeration cycle and continuously reduce ambient humidity.

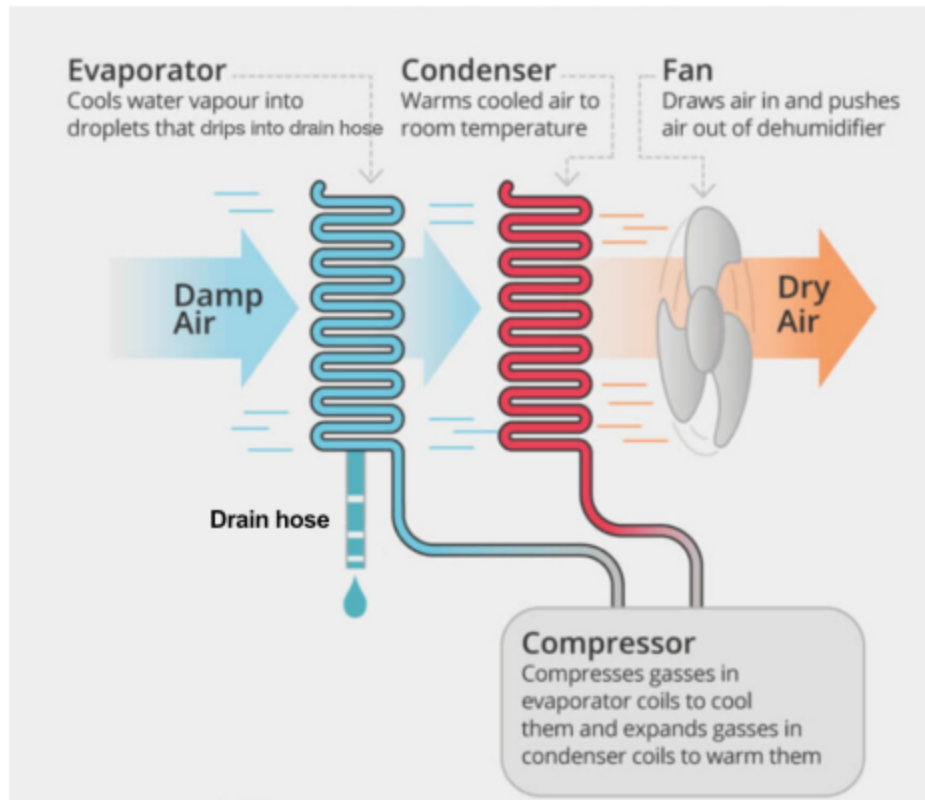

## 2.3.- Heating function (optional)

When the temperature of the box is lower than the set start threshold, Default 5°C, the dehumidification device starts the internal heater circuit (the heater is connected externally, and the power can be connected to 50-500W), until the temperature of the box rises to the set start threshold, the heater circuit stops working.

## 2.4.- RS485 communication function (optional)

When equipped with RS485, the dehumidifier communicates with the host computer by receiving and responding to data packets. A single host can connect up to 28 units (a 120 Ω termination resistor between A and B is recommended), with a max communication distance of 1000 meters. Each unit has a configurable communication address. The interface supports remote control, parameter adjustment, and fault reporting.

## **2.5.- Alarm digital output (optional)**

The dehumidifier provides a single-channel alarm digital output (DO) to indicate abnormal conditions, including sensor disconnection, power failure, and temperature or humidity exceeding preset limits.

Upon any abnormal event, the DO output triggers immediately, enabling external monitoring or integration with control systems for rapid response. The output default passive dry contact, normally open under normal operation and closed when a fault occurs.

### 3.- TECHNICAL SPECIFICATION

<b>Working power</b>	
Power supply	85-265Vac/dc, $\pm 10\%$ , 50Hz
Rated input power	300W
Dehumidification capacity	16L/day @30°C, 80%RH
Max dehumidification space	40 cubic meters
Refrigerant	R134a,130g
<b>Measurement and ability</b>	
Ambient temperature Measurement & control range	-40.0°C ~70.0°C, accuracy $\pm 1^\circ\text{C}$ , Display resolution 0.1
Ambient humidity measurement range	20.0~99.0%RH, Display resolution 0.1
Ambient humidity control range	20.0~95.0%RH
Ambient humidity accuracy	$\pm 3\%$ RH
External ambient temp. measurement range	-40°C ~70°C, Class 2.0
Heater start threshold	1~55°C, Default 5°C
Heater power	50~500W optional
Relay contact capacity	2*DO, Both dry contact, normally open For heater: 5A@250Vac/ 30Vdc For fault alarm: 3A@250Vac/ 30Vdc
<b>Safety</b>	
Dielectric strength	2kV AC RMS 1 minute, between input / output / case / power supply Input, output and power supply to the chassis $\geq 100\text{M}\Omega$
Surge (impact) immunity	GB/T 17626.5-2008, Level 3
Electrical fast transient/ burst immunity	GB/T 17626.4-2008, Level 3
Power frequency magnetic field immunity	GB/T 17626.8-2006, Level 3

<b>Other</b>	
Environment	Storage: -10°C ~50°C, ≤90%RH, no condensation Operating: 5°C ~40°C, ≤90%RH, no condensation
Dimensions (W*H*D)	Body: 309x476x239mm Base plate: 315 x275x11mm
Drain hose	Silicone, OD 10 mm, ID 8 mm, length 2/3m optional
Net weight	14KG
RS485 Communication	RS485, Modbus-RTU (Optional)

## 4.- INSTALLATION AND START-UP

### 4.1.- Base-mounted installation dimension (unit: mm)

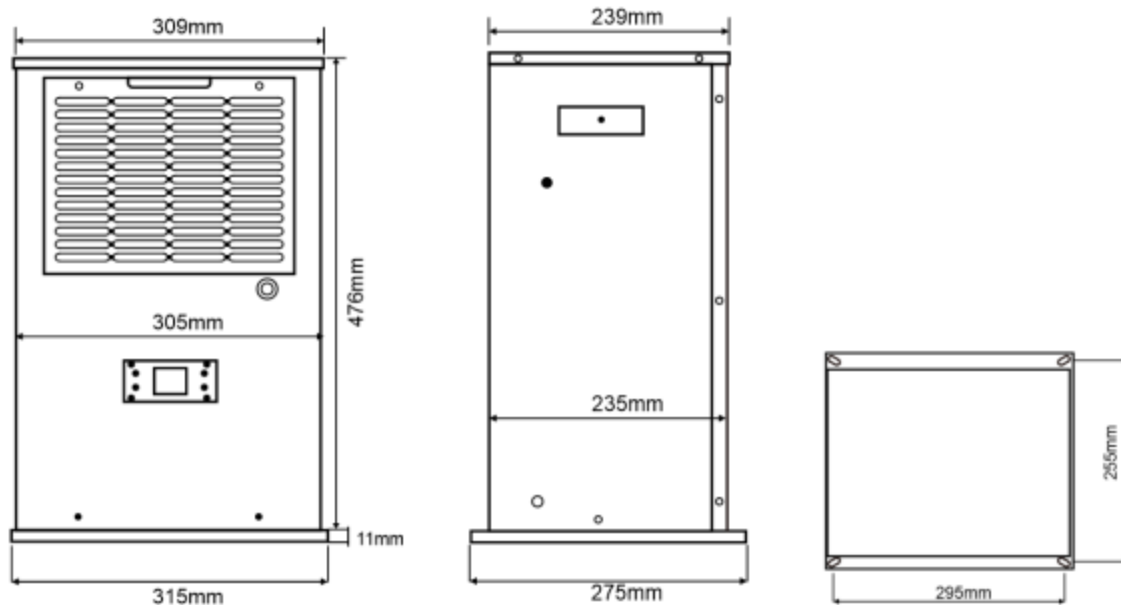

#### Notes:

1. Fix with M5 screws or 5mm rivets. When installing, the dehumidifier must be placed vertically with the water outlet facing down.
2. Ensure that there is more than 5cm of space between the front of the dehumidifier and other devices to ensure the air from the front fan outlet.
3. One end of the outlet pipe is connected to the drain of the dehumidification device, fixed with a clamp to keep the water pipe smooth and not entangled, and the other end leads to the outside of the box.
4. Connect the power terminal L/N to AC220V power supply.

### 4.2.- Connection terminal and wiring method

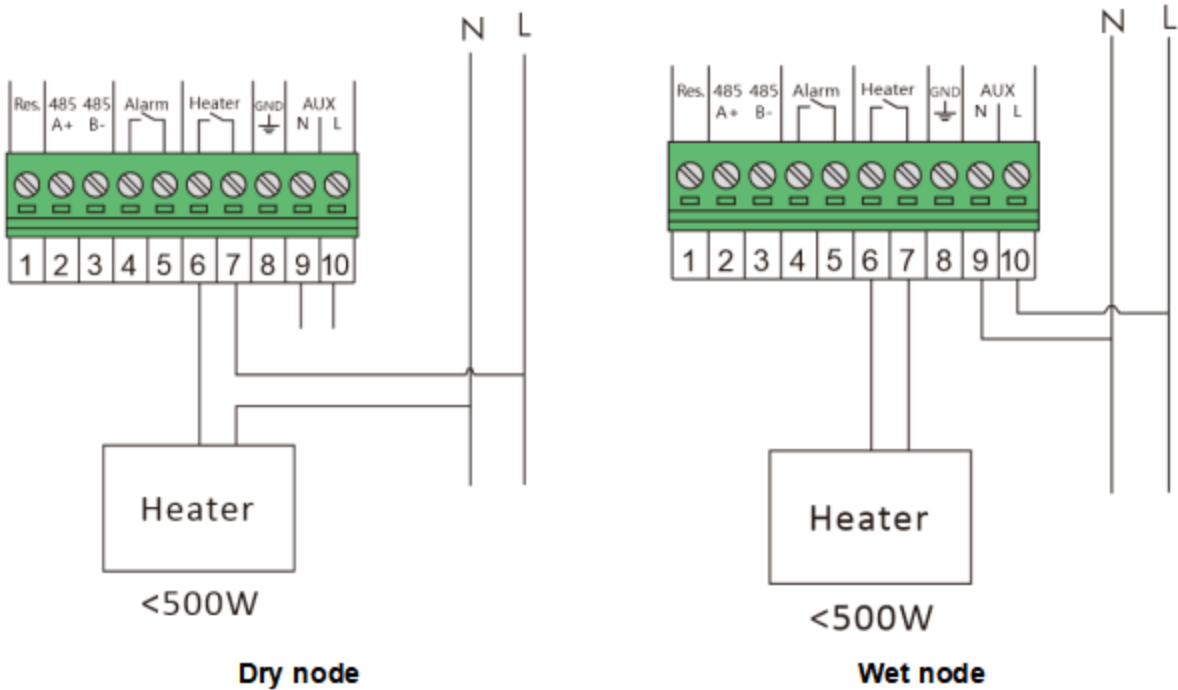





No.	Notes
1	Reserve port
2-3	RS485 communication port
4-5	Fault alarm normally open port
6-7	External heater normally open port
8	Shield ground
9-10	Power supply port

**Note:**

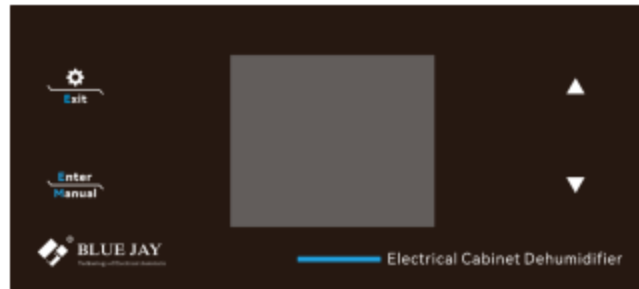
**Heater DO port:** Passive dry contact by default, external power supply required. optional active wet node version, the relay is energized and can directly drive the heater, no need external power supply.

### 4.3.- Key description



Key	In Working state	In Setting state
	/	Increase / decrease value
	Enter the setting menu	Exit the setting menu
	Switch between Auto/ Manual mode	After setting the value, press the key to confirm

## 5.- COMMUNICATION INTERFACE

This device adopts RS485/ MODBUS RTU communication protocol, baud rate 9600bps, 1 start bit, 8 data bit, no parity, 1 stop bit, that is, 1 byte of data in total 10 bits. The factory default address is 01, user can reset it according to the site conditions.

### 5.1.- MODBUS © protocol

#### Modbus RTU Frame Format

<b>Address code</b>	<b>1 BYTE</b>	Slave device address <b>1-247</b>
<b>Function code</b>	<b>1 BYTE</b>	Indicates the function codes like read coils / inputs
<b>Data code</b>	<b>4 BYTE</b>	Starting address, high byte Starting address, low byte Number of registers, high byte Number of registers, low byte
<b>Error Check code</b>	<b>2 BYTE</b>	Cyclical Redundancy Check ( <b>CRC</b> )

#### MODBUS FUNCTIONS

<b>Code</b>	<b>Meaning</b>	<b>Description</b>
<b>FUNCTION 03</b>	<b>Read holding register</b>	Read setting parameters
<b>FUNCTION 04</b>	<b>Read input registers</b>	Read setting parameters
<b>FUNCTION 10</b>	<b>Write multiple registers</b>	Set the device parameters

## 5.2.- Command samples

### 5.2.1.- Query the temperature and humidity value, Read only, “03H” code to read

#### Host inquiry

Address	01H
Function code	03H
Starting register _H	00H
Starting register _L	07H
Inquiry length _H	00H
Inquiry length _L	03H
CRC_L	XXH
CRC_H	XXH

#### Slave response

Address	01H
Function code	03H
Data length	06H
Temperature _H	...
Temperature _L	...
Humidity _H	...
Humidity _L	...
Evaporator fin _H	...
Evaporator fin temperature value - L	...
CRC_L	XXH
CRC_H	XXH

#### Example: Host inquiry

01 03 00 07 00 03 B4 0A

#### Slave response

01 03 06 00 FA 02 58 00 00 BA 07

#### Note:

When the temperature is negative value, and the most significant bit (MSB) of the 16-bit temperature value is 1, using standard two’s complement format.

For example: -10°C is expressed as 1111 1111 1111 0110

## 5.2.2.- Query setting value and working status, Read only, "04H" code to read

### Host inquiry

Address	01H
Function code	04H
Starting register_ H	00H
Starting register_ L	00H
Inquiry length_ H	00H
Inquiry length_ L	07H
CRC_ L	XXH
CRC_ H	XXH

### Slave response

Address	01H
Function code	04H
Data length	0EH
Working status	...
Working mode	...
Humidity start threshold_ H	...
Humidity start threshold_ L	...
Humidity stop threshold_ H	...
Humidity stop threshold_ L	...
Temperature start threshold_ H	...
Temperature start threshold_ L	...
Temperature HYS. threshold_ H	...
Temperature HYS. threshold_ L	...
Condenser fins threshold_ H	...
Condenser fins threshold_ L	...
Device communication address_ H	...
Device communication address_ L	...
CRC_ L	XXH
CRC_ H	XXH

### Example: Host inquiry

01 04 00 00 00 07 B1 C8

### Slave response

01 04 0E 00 00 00 4B 00 41 00 05 00 05 00 00 00 01 B9 51

Heating relay output status (01 means closed, 00 means normally open)

### 5.2.3.- Modify device parameters, Write only, “10H” code to write

#### Host inquiry

Address	01H
Function code	10H
Starting register	00H
	01H
Register NO.	00H
	06H
Inquiry length	0C
Humidity start threshold	0X004B
Humidity stop threshold	0X0041
Temperature start threshold	0X0005
Temperature HYS. threshold	0X0005
Condenser fins stop threshold	0x0001
Device address	0x0001
CRC_L	XXH
CRC_H	XXH

#### Example: Host inquiry

01 10 00 01 00 06 0C 00 4B 00 41 00 05 00 05 00 01 00 01 8E F1

#### Slave response

01 10 00 01 00 06 11 CB

#### Means that:

Humidity start threshold is set to: 75%RH

Humidity stop threshold is set to: 65%RH

Temperature start threshold is set to: 5°C

**5.2.4.- Set manual dehumidification/ auto dehumidification, Write only, “10H” code to write****Host inquiry**

Address	01H
Function code	10H
Starting register	00H
	07H
Register NO.	00H
	01H
Inquiry length	02H
Manual switch command byte	0XAA55
CRC_L	XXH
CRC_H	XXH

**Example: Host inquiry**

01 10 00 07 00 01 02 AA 55 19 78

**Slave response**

01 10 00 07 00 01 B0 08

**Means that:**

Manual/ automatic dehumidification switch command

**Note:**

Register 0007 is a multiplexed register: reading returns the ambient temperature value, writing sends manual or automatic dehumidification control commands.

### 5.3.- Register map

Register	Item	Byte	Description
0000	Working mode/ display mode	2	<p><b>The lower 8 bits indicate the working mode:</b>                      0 = Heating working mode;                      1 = Cooling working mode.</p> <p><b>The upper 8 bits indicate the working status:</b>                      0 = Automatic status;                      1 = Manual status;                      2 = Setting status;                      3 = Running status;                      4 = Dehumidifier working status;                      5 = Heater working status;                      6 = Fan working status;                      7 = Deicing working status</p> <p>Default: 0,0</p>
0001	Dehumidification start threshold	2	Range: 0 ~ +99.0%RH, default: 75%
0002	Dehumidification stop threshold	2	Range: 0 ~ +99.0%RH, default: 65%
0003	Temperature start threshold	2	Range: 0.0°C ~ 99.9°C, default: 5.0°C
0004	Temperature HYS. threshold	2	Range: 0°C ~ 20°C, default: 0.0°C
0005	Condenser fins threshold	2	Range: -9°C ~ +9°C, default: 0.0°C
0006	Device communication address	2	Range: 1~247, default: 1
0007	Ambient temperature value	2	Range: 0°C ~+99.9°C
0008	Ambient humidity value	2	Range: 0 ~ +99.0% RH
0009	Evaporator fin temperature value	2	Range: -50°C ~ +99.9°C

**Note:**

The data in register 0000 ~ 0008 involve decimal points, so the data must be multiplied by 10 or divided by 10 to get the actual data of the decimal point.

## 6.- SAFETY CONSIDERATIONS



All installation specification described at the previous chapters named:

**INSTALLATION AND STARTUP, INSTALLATION MODES and SPECIFICATIONS.**

Please note that with the instrument powered on, the terminals could be dangerous to touching and cover opening actions or elements removal may allow accessing dangerous parts. This instrument is factory-shipped at proper operation condition.

- ◆ The device must have a professional installation and maintenance.
- ◆ Any operation of the device, you must cut off the input signal and power.

## 7.- TECHNICAL SERVICE

For any inquiry about the instrument performance or whether any failure happens, contact to Blue Jay's technical service.

*Blue Jay - After-sales service*

*1802, Building 2, No.88, Jianxin East Road,  
Chongqing,400020, China*

*Tel - + 0086 023 67628702  
E-mail: tech@cqbluejay.com*