

# **Multi-channel Circuit Metering System**

## **BJ-MCM1300**

## **User Manual**

### **Version: 1.7**

## Read me

**When you use BJ-MCM1000 series Multi-channel Circuit Metering system, be sure to read this user manual carefully, and be able to fully understand the implications, the correct guidance of operations in accordance with user manual, which will help you make better use of BJ-MCM1000, and help to solve the various problems at the scene.**

1. Before the meter turning on the power supply, be sure that the power supply within the provisions of the instrument;
2. When installation, the current input terminal must non-open, voltage input terminals must Non-short circuit;
3. Communication terminal (RS232/RS485 or Ethernet) is strictly prohibited to impose on high pressure;
4. Be sure the instrument wiring consistent with the internal system settings;
5. When communicating with the PC, instrument communication parameters must be consistent with the PC.



- **Please read this user manual carefully**
- **Please save this document**

# Directory

<b>CONTENTS</b>	<b>Page</b>
<b>1. - SUMMARIZE.....</b>	<b>- 4 -</b>
2. - ELECTRICITY METERING.....	- 5 -
<b>3. - SPECIFICATIONS .....</b>	<b>- 6 -</b>
<b>4.- INSTALLATION AND START-UP.....</b>	<b>- 8 -</b>
4.1.- INSTALLATION.....	- 8 -
4.2. - CONNECTION TERMINAL.....	- 11 -
<b>5. SCREEN DISPLAY .....</b>	<b>- 13 -</b>
5.1. - PANEL DIAGRAM.....	- 13 -
5.2.- DISPLAY UNIT CONNECTION .....	- 13 -
<b>6. - OPERATION MODE .....</b>	<b>- 14 -</b>
<b>7. - SETUP PROCEDURE .....</b>	<b>- 18 -</b>
7.1.- INPUT PASSWORD.....	- 18 -
7.2.- MENU TREE QUICK GUIDE .....	- 18 -
7.3. – DETAILS EXPLAIN OF MENU STRUCTURE .....	- 20 -
7.4.- DISPLAY CHARACTER INSTRUCTIONS .....	- 21 -
<b>8.- COMMUNICATION INTERFACE.....</b>	<b>- 22 -</b>
8.1.- CONNECTION FOR THE RS485 BUS.....	- 22 -
8.2.- MODBUS © PROTOCOL .....	- 22 -
8.3. - REGISTER ADDRESS TABLE .....	- 23 -
8.4.- EXAMPLE.....	- 29 -
<b>9. - SAFETY CONSIDERATIONS .....</b>	<b>- 30 -</b>
<b>10. - MAINTENANCE.....</b>	<b>- 30 -</b>

## 1. - SUMMARIZE

The MCM1000 Series provides a compact and robust metering solution, enable reliable monitoring of building electrical loads with a low installation cost-per-point by combining sub-metering. The unit performs real-time metering, measures energy consumption for max 18 channel circuits for single phase or 6 channel for three phase circuits.

Advanced communications options including Modbus via RS485, I/O communications provide for extensive reliable data exchange. Multiple units can be connected together to meter unlimited number of circuits. The versatility of MCM1000 meters are ideal for multi-tenant or departmental metering applications within office towers, condominiums, apartment buildings, shopping centers and other multi-user environments.

### Measurement Function

**Voltage:** Line Voltage; Phase Voltage

**Current:** Total Current; Current per channel

**Power and Power Factor:** Total power Reactive Power, Apparent Power, Power Factor and for per channel

**Frequency:** System Frequency

### Energy Function

Energy (kWh) measurement meeting international standards, accuracy is Class 1.0.

### Over/Under Limit Alarming

Users can select parameters and set their set points. An alarm will be triggered when the setpoint is reached. At the same time, sound and light signals could be sent out via relay output. The time and reason of an alarm event will be recorded.

### I/O Option

Standard output ports provide energy (kWh) pulse output and time pulse output; optional 6 channel digital inputs (DI) provide pulse counting from water, electricity and gas meter, and monitor switch status; optional 2 channel relay outputs (DO) react upon alarming conditions.

### Communication and Network

Supports RS485 communication open protocol: Modbus RTU;

Tel: +0086-023-67628702

[www.cqbluejay.com](http://www.cqbluejay.com)

Add: 1802, Building 2, No.88, Jianxin East Road, Chongqing, 400020, China

Email: [tech@cqbluejay.com](mailto:tech@cqbluejay.com)

## 2. - ELECTRICITY METERING

MCM1000 series has two models:

MCM13xx - three phase measurement, max connect 6 channel three phase circuit

MCM11xx -single phase measurement, max connect 18 channel single phase circuit.

The MCM delivers the of parameters listed by RS485 ports, Blue Jay Technology also provide advanced model can connect display unit show visualization information, and do configuration of the MCM device. In the main display area shows 4 power parameters, with other display area show the various parameters and state of meter on each page jump. For more details of measurement parameters please refer to the subsequent for displays introduction.

### Metering parameter overall

Function		Parameter	MCM1310	MCM1320
Real-time Parameter	Voltage	Va, Vb, Vc / Vab, Vbc, Vca	●	●
	Current	per channel / per phase	●	●
	Power	per channel / per phase	●	●
	Reactive Power	per channel / per phase	●	●
	Apparent Power	per channel / per phase	●	●
	Power Factor	per channel / per phase	●	●
	Frequency	per channel	●	●
Energy	Active Energy +	per channel	●	●
	Reactive Energy +	per channel	●	●
	Active Energy -	per channel	●	●
	Reactive Energy -	per channel	●	●
Communication	RS485	Modbus-RTU	●	●
Alarming	Over/Under Limit Alarm		○	●
I/O	6DI & 2DO		○	●
Display	External LCD display	(RS485 connection)		●

Notes: "●" for Standard; "○" for Optional; Blank means Not Available

### 3. - SPECIFICATIONS

**Reference standard:**

Basic electricity: IEC 61557-12:2007

Active energy: IEC 62053-21:2003

Reactive energy: IEC 62053-23:2003

**Accuracy standards**

Parameter	Accuracy	A phase	B phase	C phase	All
Voltage	0.2	V1	V2	V3	
Current	0.2	A1	A2	A3	
Active Power	0.5	W1	W2	W3	W
Reactive Power	0.5	var1	var2	var3	var
Apparent power	0.5	VA1	VA2	VA3	VA
Power Factor	0.5	PF1	PF2	PF3	PF
Active Energy	1				Wh
Reactive Energy	2				varh
Frequency	0.1				Hz

**Input**

Voltage: Rated 40~400V

Current: Rated 5A (optional 1A)

Frequency: 45-65Hz

**Overload**

Current: 1.2 times rated continuous; 5 seconds for 10 times the rated

Voltage: 30 seconds for 2 times the rated

**Dielectric strength**

IEC/EN 61010-1:2010

2kV AC RMS 1 minute, between input / output / case / power supply

**EMC Test**

	standard	Test voltage
Electrostatic discharge immunity test:	IEC-61000-4-2 level 4	8Kv
Electrical fast transient burst immunity test	IEC61000-4-4 level 3	Input 1kV; Power supply 2kV
Surge (Shock) immunity test	IEC61000-4-5 level 4	common mode test voltage 4kV

**Work environment**

Temperature: -15C~ +55C

Humidity: RH 20%~95% (No condensation)

**Storage Conditions**

Temperature: -25C~+70C

Humidity: RH 20%~95%

**Working Power**

AC 80-265V, 45-65Hz, DC 100-350V

DC 20-60V (Optional)

Maximum power consumption 6W

**Dimensions**

L × H × D =180mm×122mm×48mm

**Installation**

35mm Din-Rail

## 4.- INSTALLATION AND START-UP



The manual you hold in your hand contains information and warnings that the user should respect in order to guarantee a proper operation of all the instrument functions and keep it in safety conditions. The instrument must not be powered on and used until its definitive assembly is on the cabinet's door.

**If the instrument is not used as manufacturer's specifications, the protection of the instrument will be damaged.**

When any protection failure is suspected to exist (for example, it presents external visible damages), the instrument must be immediately powered off. In this case contact a qualified service representative.

### 4.1.- Installation

#### Mounting

This meter is DIN rail mounted, which fits 35 mm standard rails. Keep all connections into the cabinet. Note that with the instrument powered on, the terminals could be dangerous to touch and cover opening actions or elements removal may allow accessing dangerous parts. Therefore, the instrument must not be used until this is completely installed.



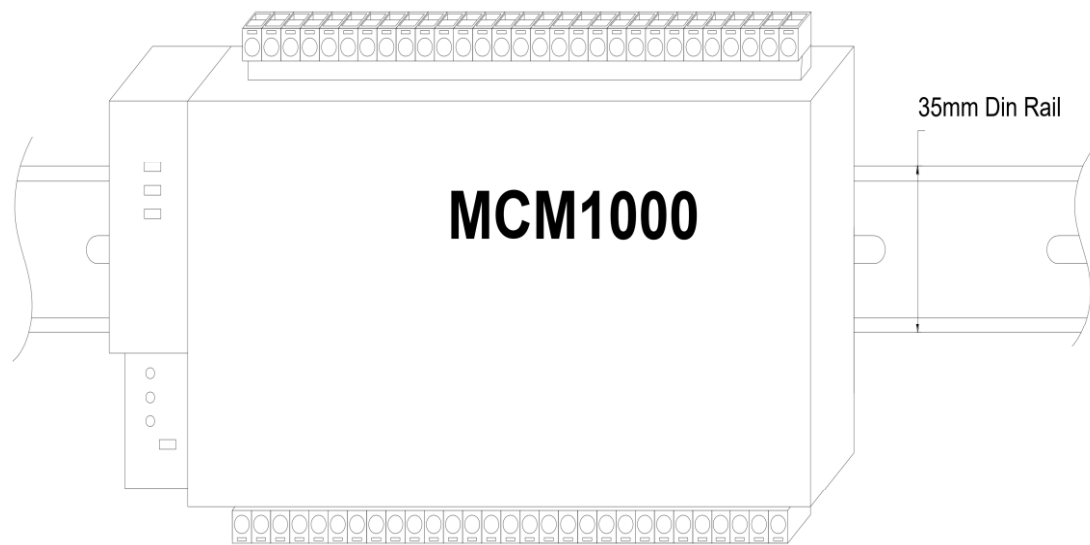

**Notes:**

Input signal: MCM1000 using a separate acquisition calculate for each measurement channel, to ensure consistent in use, for different load forms, it's a variety of connection mode. Access wire shall be met: the current 2.5 square mm, voltage of 1.5 square millimeters.

**A. Voltage input:**

Input voltage should not exceed the rated input voltage products (100V or 400V), Otherwise, you should use external CT. Suggest 1A fuse be installed in the voltage input side.

**B. Current Input:**

Standard input current is 5A, if greater than 5A should use external CT. When the CT is connected with other instruments, make sure wiring methods be used in series.

Before remove the current input connection, must be sure to disconnect the primary circuit or shorted secondary circuit of CT. In order to facilitate disassembly, please do not connect to CT directly, and the terminal block is suggested.

**C. Please make sure that the input voltage and current corresponding to the same phase sequence, and the same direction; Otherwise, the Values and symbols will be wrong!! (Power and Energy)**

The input network configuration of instrument depends on the CT number of the system:

in the condition of 2 CT, select the three-phase, three-lines two components;  
in the condition of 3 CT, select the three-phase, four-lines three component mode.

Instrument connection mode, set of the instrument (programming input network NET) should be the same load wiring as measured wiring. Otherwise, the measurement instrument will lead to incorrect voltage or power.

In three-phase three-wire mode, the measurement and shows the line voltage;  
In three-phase four-wire mode, the measurement and shows the phase voltage.

**Auxiliary power:**

MCM1000 Series with universal (AC / DC) power input, if not for a special statement, we provide the 220VAC or 110V/DC power interface for standard products. Instruments limit work power supply: AC: 85-265V / DC: 100~300V, please ensure that the auxiliary power can match with MCM1000 series meter to prevent damage to the product.

- A. Suggest install 1A fuse in the fire line side.
- B. For the areas with poor power quality, suggest install lightning surge suppressor and rapid burst suppressor to prevent lightning strikes.

## 4.2. - Connection Terminal

Meter Base Terminals:

Upper row: Digital input, Current Sampling (4-6) Pulse Output, Relay Output

Lower row: Voltage sampling, Current Sampling (1-3), Display port, Communication, Power Supply

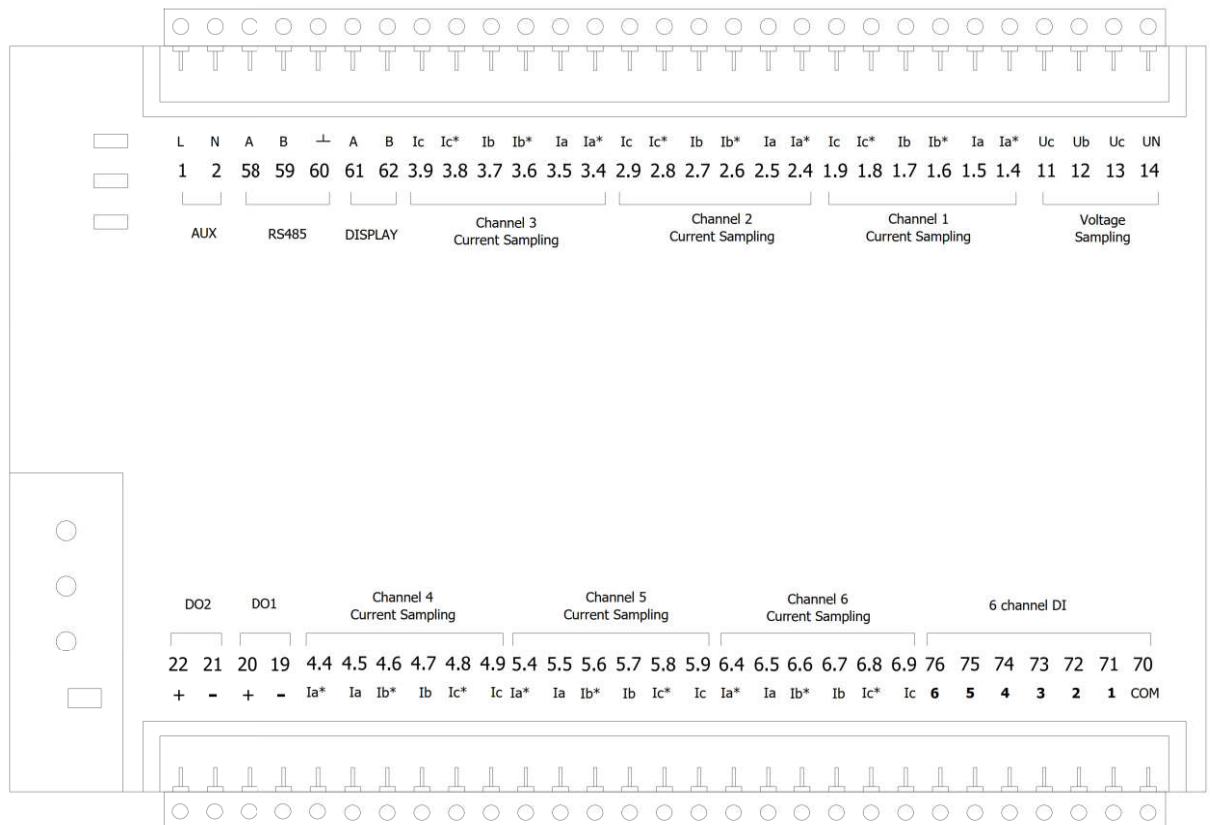

**Notes:** The terminal pin will change depends on customer order; please refer to the label on the meter!

Typical wiring- 3P4W (max 6channel)

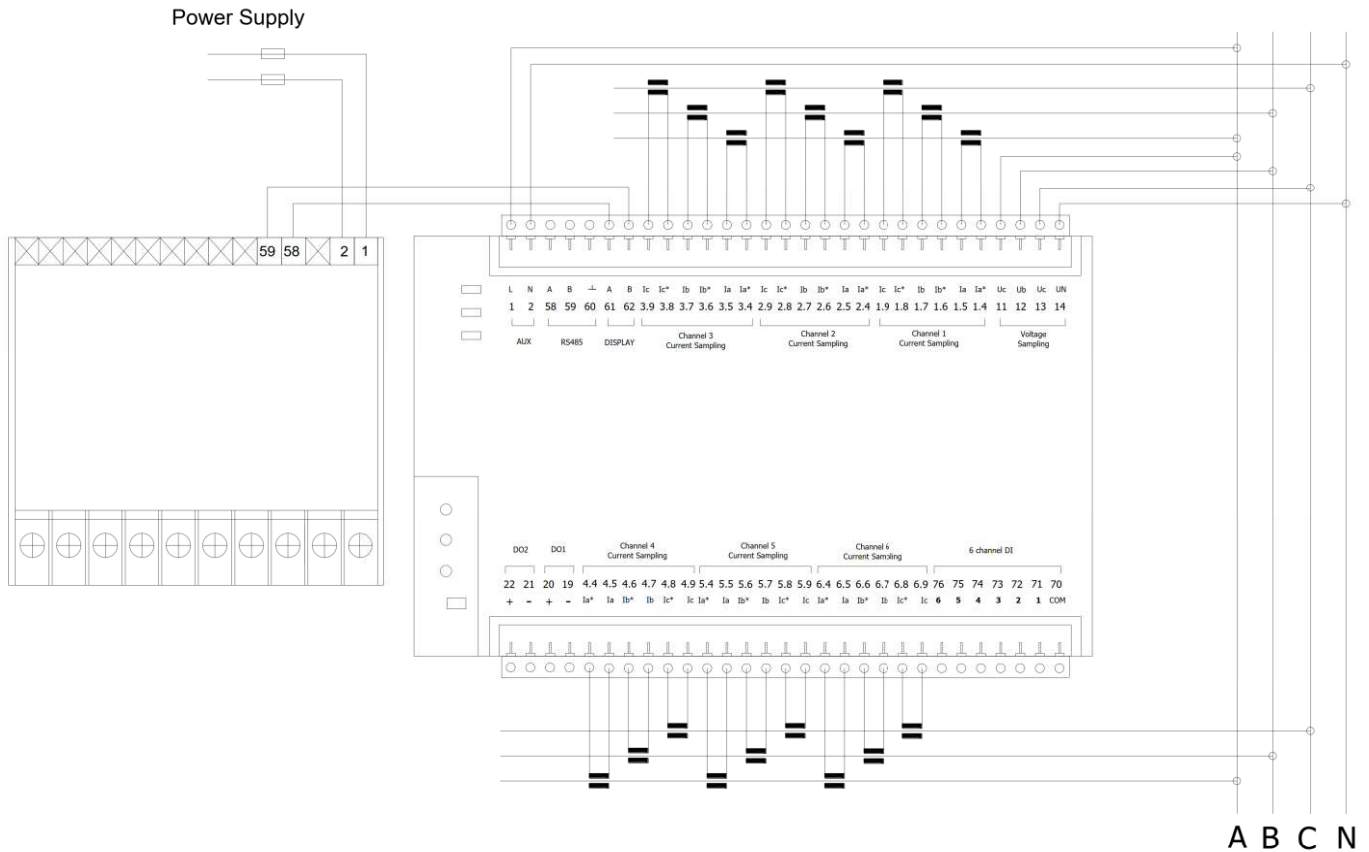

**IMPORTANT REMARK!**

If power = -0.01 is shown for any of the phases and voltage and current are not zero for this phase, check out following points:

- Assure that A, B and C phases coincide in voltage and current.
- Correct polarity? Reverse the current transformer placed at this phase.

**Note:** This connection drawing is for reference only; the actual connecting terminal please refer to the label on the rear part.

## 5. SCREEN DISPLAY

### 5.1. - Panel Diagram

MCM1000 optional LCD screen module, connect to RS485 wire to MCM body "DISPLAY" pin, provide electrical data display and on-site configuration.

**Note:** If your MCM do not have external display unit, please skip chapter 5 and chapter 6, and use RS485 port for operation.

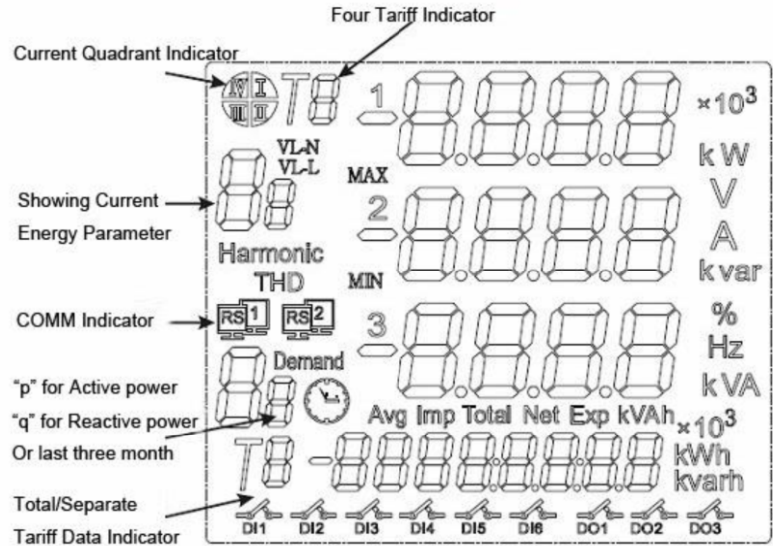

### 5.2.- Display unit

#### connection

Display unit shape and size are same as 194 series power meter. need 85~265VAC/DC AUX power, RS-485 cabling must be carried out with a meshed screen cable (minimum 3 wire), diameter of not less than 0.5mm<sup>2</sup>, with a maximum distance of 50m between the MCM1000 and the display unit

This unit is to be mounted on panel (cut-out 70+0.8 x 70+0.8 mm). Keep all connections into the cabinet.

Note that with the instrument powered on, the terminals could be dangerous to touch and cover opening actions or elements removal may allow accessing dangerous parts. Therefore, the instrument must not be used until this is completely installed.

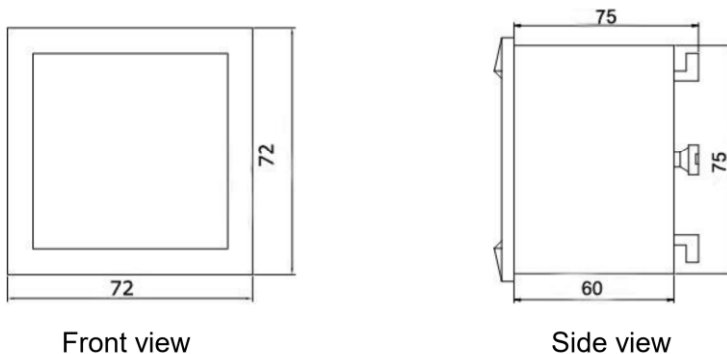

#### size of display unit



## 6. - OPERATION MODE

When the MCM1000 and display unit are powered up, the entire symbol will be on, and the meter starts to self- test. After some seconds, the meter is ready for operation and shows one of the available screens.



Parameters on display can be switched by pressing key  or  LCD shown on screen at any moment

When the key  is pressed, the screen CURRENT values of each phase are now showing.

Pressing again the key , the screen will show the following parameters successively.

In setting menu, pressing key  move the setting cursor to left;

Pressing  can enter the number 0 ~ 9.





This key named "SET" key, pressing it can open the programming menu and return to previous menu.



This key named "Enter" key, pressing this key you can exit it with saving any modification that you might have done, in menu operation press "Enter" key, and user can go to the next menu.

### Note:

Press key  or  in normal standby status, and the meter will show different data in main screen:

In the menu set mode, when changes the parameter and exit setting, the meter will ask to "SAVE",

press  *exit without saving*

press  *save and exit.*

**Screen 1:** Displays the three phase voltage  $U_a$ ,  $U_b$ ,  $U_c$ ;  
 As shown:  $U_a = 380.0V$ ;  $U_b = 380.0V$ ;  $U_c = 380.0V$ ;

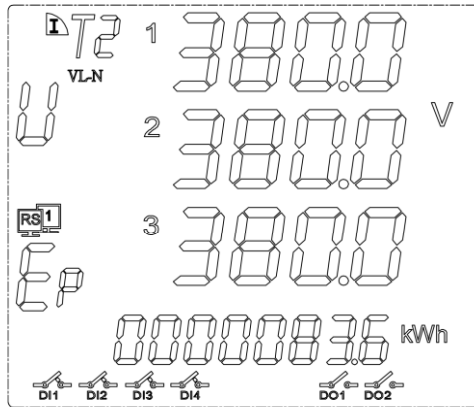

In the bottom character “Ep” show **total active energy** is 83.6KWh.

In other display area region show the system information:

$DI1$ ,  $DI2$ ,  $DI3$ ,  $DI4$  in the close state;

$DO1$ ,  $DO2$  in the open state;

Communication transceiver normal;

**Note:** Detail information for each symbol, please refer **chapter 5**, following sections as same

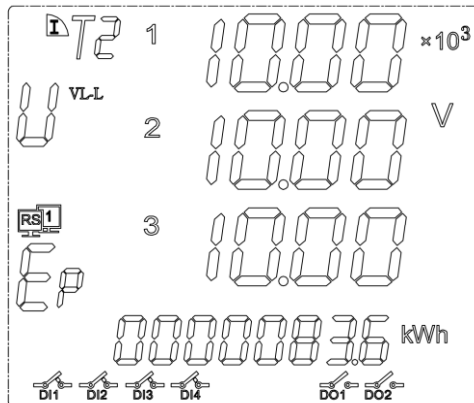

**Note:** in the high voltage measurement,  $X10^3$  mean the showing voltage value multiplied by 1000, in the screen diagram mean the voltage is  $10 \times 1,000 = 10,000$ volt

**Screen 2:** Display the three-phase current Ia, Ib, Ic.

In the bottom **Ep** shows **total negative active energy**.

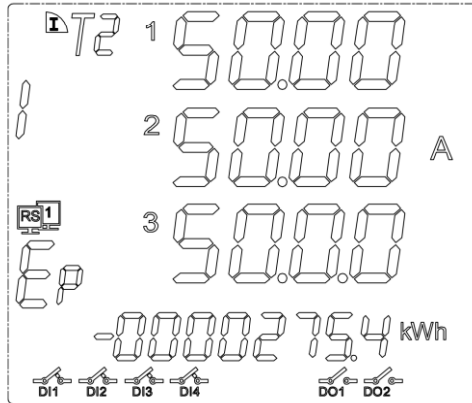

**Screen 3:** Display the total active power, total reactive power, and total factor.

In the bottom "**Eq**" shows **total active energy**.

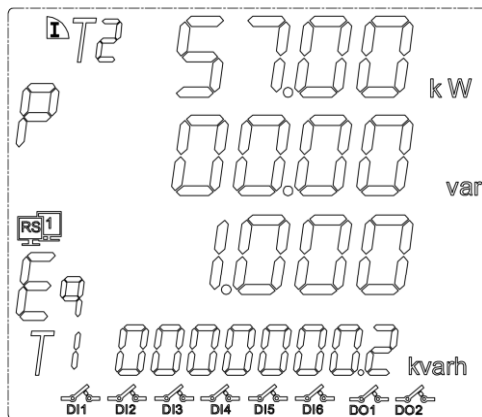

**Screen 4:** Display the frequency of a phase.

In the bottom "**Eq**" shows **total negative reactive energy**.



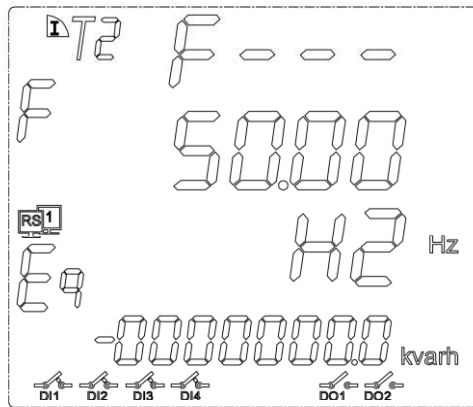

## 7. - SETUP PROCEDURE

This chart just suits MCM1310 and MCM1110, or client optional display unit, other models please skip this chart to RS485 communication guide, use any series scan programming also can do same setting!!



Once into the SETUP, use the keyboard to select different options and enter required variables:

### 7.1.- Input Password

A 4-figure password is required to be entered (in case that in case that the meter will work without permission.)

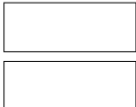
At normal display mode, press  to enter the programming mode, meter display

Meter display "  " ,  

Ask for the password. Press  to input the password number, from "0~9". Press  to move the cursor. After password switch press  to confirm the input.

If password is correct, meter can enter next setting.

**Notes:** the default password is 0001.

### 7.2.- Menu tree quick guide

In the Setup menu, include following 4 parts:

**SYS**  
**-IN-**  
**BUS**  
**DO**

Sub-menu please refer to following drawing:

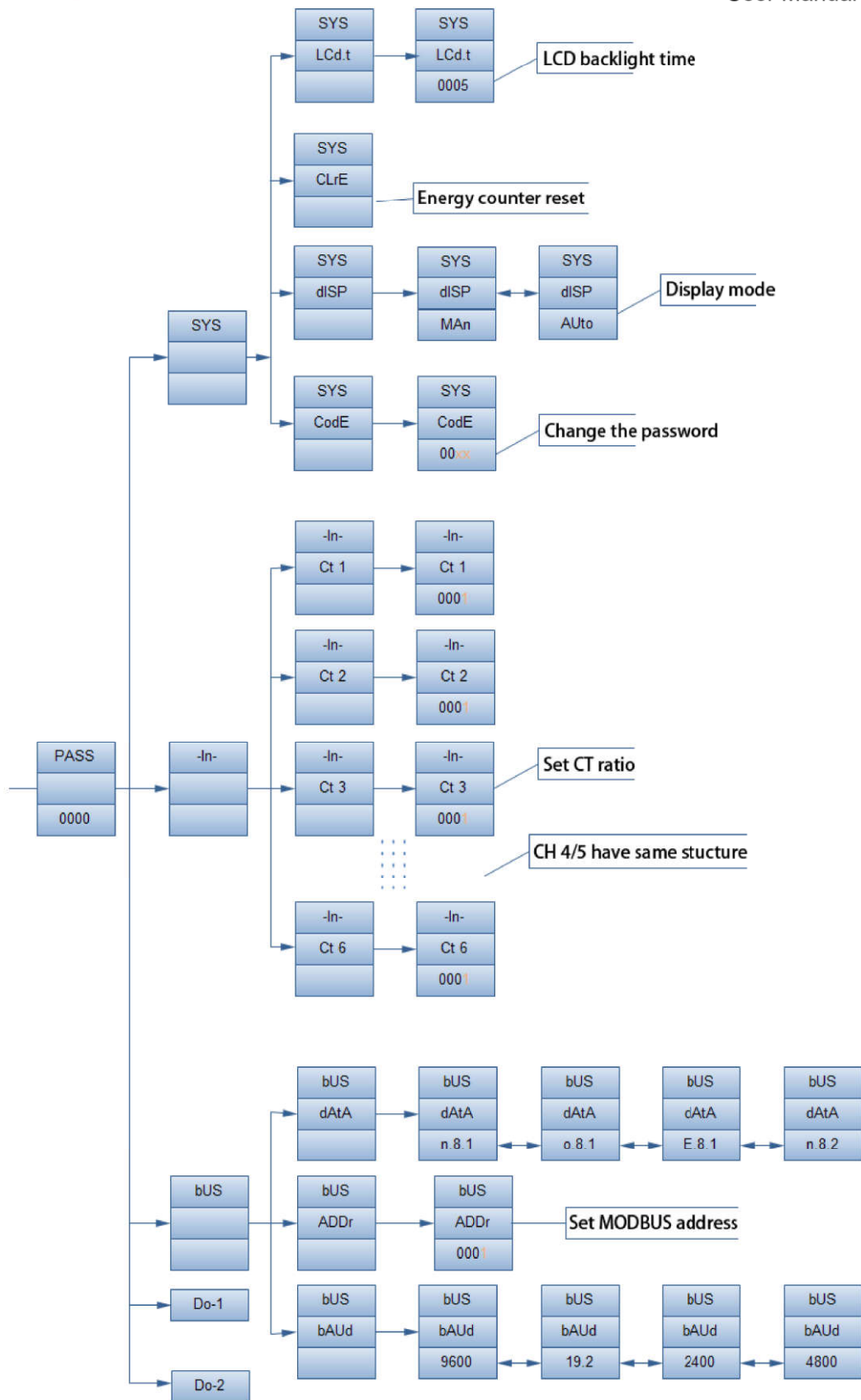

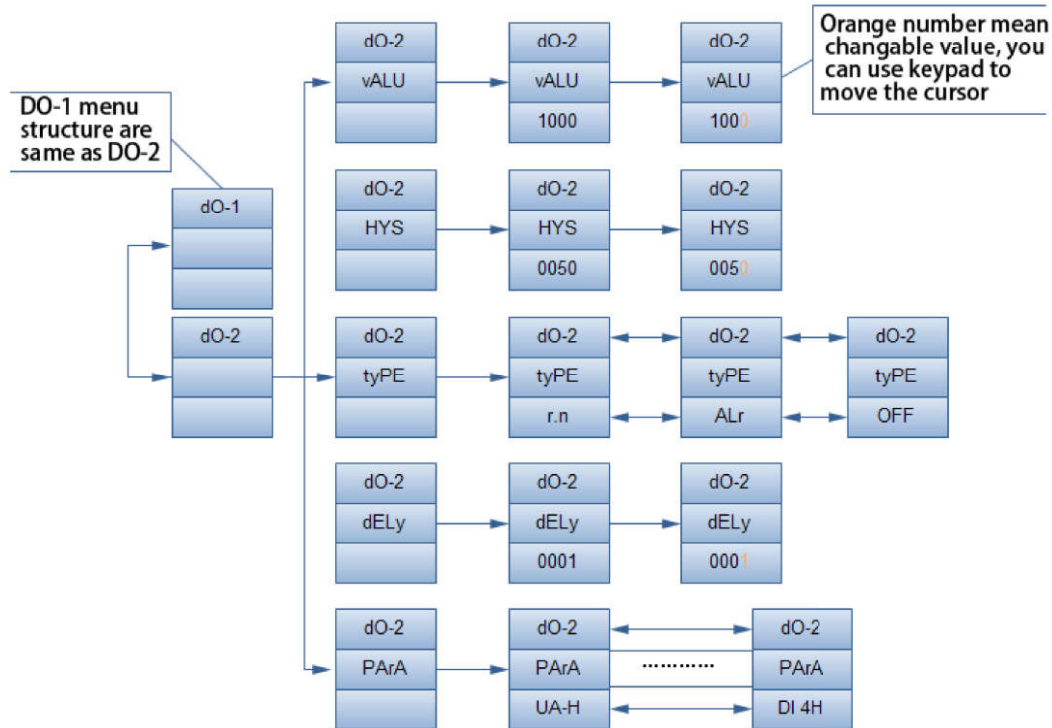

### 7.3. – Details explain of menu structure

level 1	Level 2	Level 3	Description
(System setting) <b>SYS</b>	(LCD backlight time) <b>LCd.t</b>	0000~1000	Factory default is 0005
	(Energy counter reset) <b>CLr.E</b>		Unrecoverable for Clear data
	(Display mode) <b>dISP</b>	0-99	0 for manual switching, 1-99 for X sec auto switch to next screen Factory default is manual
	(Change the password) <b>CodE</b>	0000~9999	Default is 0001
(Signal input) <b>-IN-</b>	(Net) <b>Lin.e</b>	N.3.4, N.3.3, N.1	Select the input signal network measurement
	(Voltage Range) <b>U.SCL</b>	100V, 220V, 380V	Select the range of measured voltage signal
	(Current Range) <b>I.SCL</b>	5A and 1A	Select the range of measured current signal
	(Voltage transformation ratio) <b>R.PT</b>	1-9999	Setting voltage signal transformation ratio = 1 / 2 scale

	(Current transformation ratio) <b>R.CT</b>	1-9999	Setting current signal transformation ratio = 1 / 2 scale
(Communication Parameters) <b>bUS</b>	(Address) <b>ADDR</b>	1-247	Instrument address range 1-247
	(Communication speed) <b>BAUD</b>	4800~9600	Default is 9600
	Protocol <b>DATA</b>	o.8.1; e.8.1; n.8.1	Factory default communication mode for the word ( <b>n.8.1</b> )
(Digital output setting) <b>DO-1 to DO-2</b>	(Output type) <b>TYPE</b>	r.n, Alr, OFF	Default is Alr
	(Set output delay) <b>DELY</b>	0000~9999	Default is 0010
	Choose the electrical parameter <b>PARA</b>	I3-H, PS-H...U3-H	Default is I3-H
	(Set the alarm value) <b>VALU</b>	0000~9999	Default is 0050
	hysteresis value <b>HYS</b>	4800~9600	Default is 4800

#### 7.4.- Display Character instructions

PRSS	User passwords	USCL	Input voltage range selection
Erro	Input error	I.SCL	Input current range selection
-1 n.-	User settings menu	r. Ct	Set CT ratio
bUS	Communication settings menu	r. Pt	Set PT ratio
SCAL	Shows scal input value	LI nE	Select phase
Pol t	Set the decimal point	do-1	Route 1 switch output settings
dAtA	Communication parameter setting	do-2	Route 2 switch output settings
Addr	Metter address setting	SYS	System parameter settings
bAUD	Baud rate	tYPE	Choose set parameter
o.8.1	8 data bits, 1 stop bit, even parity	PARA	The corresponding parameters
e.8.1	8 data bits, 1 stop bit, odd parity	VALU	Set the alarm value
n.8.1	8 data bits, 1 stop bit, no parity	LdI S	Show Low alarm setting
SUR E	Confirm the change	HdI S	Show High alarm setting
Code	System password		

## 8.- COMMUNICATION INTERFACE

### 8.1.- Connection for the RS485 BUS

The composition of the RS-485 cabling must be carried out with a meshed screen cable (minimum 3 wire), diameter of not less than 0.5mm<sup>2</sup>, with a maximum distance of 1,200 meters between the MCM1000 and the master unit. This Bus may connect a maximum of 247 MCM1000

**Note:**

1. Full range of MCM1000 meter RS485 PIN number is 58,59,60
2. Due to product modifications or custom requirements, the interface pin place may be change.  
For details, please refer to product label on the rear board

### 8.2.- MODBUS © protocol

**Modbus RTU Frame Format:**

<b>Address code</b>	<b>1 BYTE</b>	<i>Slave device address 1-247</i>
<b>Function code</b>	<b>1 BYTE</b>	<i>Indicates the function codes like read coils / inputs</i>
<b>Data code</b>	<b>4 BYTE</b>	<i>Starting address, high byte Starting address, low byte Number of registers, high byte Number of registers, low byte</i>
<b>Error Check code</b>	<b>2 BYTE</b>	<i>Cyclical Redundancy Check (CRC)</i>

### MODBUS FUNCTIONS

<b>Code:</b>	<b>Meaning:</b>	<b>Description:</b>
<b>FUNCTION 03</b>	Reading of n Words	<i>This function permits to read all the electrical parameters of the BJ...series.</i>
<b>FUNCTION 06</b>	Write of Registers	<i>Write value in to the relevant register</i>

**Notes:** Blue Jay Default disable the write function, if want change configuration via RS485, please contact Blue Jay Sales Team before your order.

### 8.3. - Register address table

#### 8.3.1- Basic Power Data—Primary Side

Address	Data	Byte mode		Instruction
0x00	Ua	float	2	Channel_1 Phase to Line Voltage, Unit: V
0x02	Ub	float	2	
0x04	Uc	float	2	
0x06	Uab	float	2	Channel_1 Phase to Phase Voltage, Unit: V
0x08	Ubc	float	2	
0x0a	Uca	float	2	
0x0c	Ia	float	2	Channel_1 Three phase Current, Unit: A
0x0e	Ib	float	2	
0x10	Ic	float	2	
0x12	Pa	float	2	Channel_1 Individual phase active power, Unit: kW
0x14	Pb	float	2	
0x16	Pc	float	2	
0x18	$P\Sigma$	float	2	Channel_1 Total active power, Unit: kW
0x1a	Qa	float	2	Channel_1 Individual phase reactive power, Unit: kVar
0x1c	Qb	float	2	
0x1e	Qc	float	2	
0x20	$Q\Sigma$	float	2	Channel_1 Total reactive power, Unit: kVar
0x22	Sa	float	2	Channel_1 Individual apparent power, Unit: kVA
0x24	Sb	float	2	
0x26	Sc	float	2	
0x28	$S\Sigma$	float	2	Channel_1 Total apparent power, Unit: kVA
0x2a	PFa	float	2	Channel_1 Individual power factor, 0~1.000
0x2c	PFb	float	2	
0x2e	PFc	float	2	
0x30	$PF\Sigma$	float	2	Channel_1 Total power factor, 0~1.000
0x32	FR	float	2	Channel_1 Frequency, Unit:0.01Hz
0x34	Ep+	float	2	Channel_1 Positive active energy, Unit: kWh
0x36	Ep-	float	2	Channel_1 Negative active energy, Unit: kWh
0x38	Eq+	float	2	Channel_1 Positive reactive energy, Unit: kVarh
0x3a	Eq-	float	2	Channel_1 Negative reactive energy, Unit: kWh
0x64~ 0x9e	/	float		Channel_2 Electrical data

0xc8~ 0x102	/	float		Channel_3 Electrical data
0x12c~ 0x166	/	float		Channel_4 Electrical data
0x190~ 0x1ca	/	float		Channel_5 Electrical data
0x1f4~ 0x22e	/	float		Channel_6 Electrical data

Float data follow IEEE754, float low bit first, high bit next. (CD AB)

### 8.3.2 - Basic Power Data—Secondary Side

Address	Data	Byte mode		Instruction
0x258	Ua	int	1	Channel_1 Phase to Line Voltage, Unit: 0.1V
0x259	Ub	int	1	
0x25a	Uc	int	1	
0x25b	Uab	int	1	Channel_1 Phase to Phase Voltage, Unit: 0.1V
0x25c	Ubc	int	1	
0x25d	Uca	int	1	
0x25e	Ia	int	1	Channel_1 Three phase Current, Unit: 0.001A
0x25f	Ib	int	1	
0x260	Ic	int	1	
0x261	Pa	int	1	Channel_1 Individual phase active power, Unit: W
0x262	Pb	int	1	
0x263	Pc	int	1	
0x264	$P\Sigma$	int	1	Channel_1 Total active power, Unit: W
0x265	Qa	int	1	Channel_1 Individual phase reactive power, Unit: Var
0x266	Qb	int	1	
0x267	Qc	int	1	
0x268	$Q\Sigma$	int	1	Channel_1 Total reactive power, Unit: Var
0x269	Sa	int	1	Channel_1 Individual phase apparent power, Unit: VA
0x26a	Sb	int	1	
0x26b	Sc	int	1	
0x26c	$S\Sigma$	int	1	Channel_1 Total apparent power, Unit: VA
0x26d	PFa	int	1	Channel_1 Individual power factor, 0~1.000
0x26e	PFb	int	1	
0x26f	PFc	int	1	
0x270	$PF\Sigma$	int	1	Channel_1 Total power factor, 0~1.000
0x271	FR	int	1	Channel_1 Frequency, Unit:0.01Hz
0x272	Ep+	int	2	Channel_1 Positive active energy, Unit: Wh
0x273	Ep-	int	2	Channel_1 Negative active energy,



				Unit: Wh
0x274	Eq+	int	2	Channel_1 Positive reactive power, Unit:Varh
0x275	Eq-	int	2	Channel_1 Negative reactive power, unit: Varh
0x2bc~0x2d9	/	int	/	Channel_2 electrical data
0x320~0x33d	/	int	/	Channel_3 electrical data
0x384~0x3a1	/	int	/	Channel_4 electrical data
0x3e8~0x405	/	int	/	Channel_5 electrical data
0x44c~0x469	/	int	/	Channel_6 electrical data

### 8.3.3- Meter status data

Address	Data	Byte mode		Instruction
0x4b0	DO	int	1	Digital output: Bit 0~1 show channel 1and channel 2 status 0 for open, 1 for closed
0x4b1	DI	int	1	Digital input: Bit 0~5 show channel 1 to channel 6 status 0 for open, 1 for closed

### 8.3.4- R/W parameters

**Notes:** If do not clear the MCM1000 communication parameter, please shot the "RESET" pin and hole 5sec for recover the communication to default setting

**Default setting:**

address: 1

Baud ratio: 9600

Data format: n.8.1

Address	Item	Byte mode		Description
0x4ba	Port_1 COMM address	Int	1	Range: 1-247
0x4bb	Port_1 Baud Ratio	Int	1	0: 2400 1: 4800 2: 9600 3: 19200
0x4bc	Port_1 Data format	Int	1	0: n.8.1 1: o.8.1 2: e.8.1 3: n.8.2
0x4bd	Port_2 COMM address (for DISPLAY unit)	Int	1	Disallowed configuration when work with DISPLAY unit! or will may display error; If done some change, please shot the "RESET" for recover the fault setting
0x4be	Port_2 Baud Ratio (for DISPLAY unit)	Int	1	
0x4bf	Port_2 Data format (for DISPLAY unit)	Int	1	
0x4c0~0x4c3	/	Int	1	reversed
0x4c4	DO1 Mode	Int	1	0: Remote 1: Alarm 2: OFF
0x4c5	DO1 Act delay	Int	1	Alarm mode: 0.0-999.9sec Remote mode: 0: Level mode Other value: 0.1-999.9sec (Pulse width)
0x4c6	DO1 Alarm data	Int	1	0: UA upper alarm 1: UB upper alarm 2: UC upper alarm 3: UAB upper alarm 4: UBC upper alarm 5: UCA upper alarm 6: UA/UB/UC upper alarm 7: channel_1 IA upper alarm 8: channel_1 IB upper alarm 9: channel_1 IC upper alarm 10: channel_2 IA upper alarm 11: channel_2 IB upper alarm 12: channel_2 IC upper alarm 13: channel_3 IA upper alarm 14: channel_3 IB upper alarm 15: channel_3 IC upper alarm 16: channel_4 IA upper alarm 17: channel_4 IB upper alarm 18: channel_4 IC upper alarm 19: channel_5 IA upper alarm 20: channel_5 IB upper alarm 21: channel_5 IC upper alarm 22: channel_6 IA upper alarm 23: channel_6 IB upper alarm 24: channel_6 IC upper alarm 25: current upper alarm for any channel 26: PA upper alarm 27: PB upper alarm

			<p>28: PC upper alarm  29: total active power upper alarm  30: QA upper alarm  31: QB upper alarm  32: QC upper alarm  33: total reactive power upper alarm  34: SA upper alarm  35: SB upper alarm  36: SC upper alarm  37: total apparent power upper alarm  38: total power factor upper alarm  39: frequency upper alarm  40: DI1 close alarm  41: DI2 close alarm  42: DI3 close alarm  43: DI4 close alarm  44: DI5 close alarm  45: DI6 close alarm</p> <p>46: UA lower alarm  47: UB lower alarm  48: UC lower alarm  49: UAB lower alarm  50: UBC lower alarm  51: UCA lower alarm  52: UA/UB/UC lower alarm  53: channel_1 IA lower alarm  54: channel_1 IB lower alarm  55: channel_1 IC lower alarm  56: channel_2 IA lower alarm  57: channel_2 IB lower alarm  58: channel_2 IC lower alarm  59: channel_3 IA lower alarm  60: channel_3 IB lower alarm  61: channel_3 IC lower alarm  62: channel_4 IA lower alarm  63: channel_4 IB lower alarm  64: channel_4 IC lower alarm  65: channel_5 IA lower alarm  66: channel_5 IB lower alarm  67: channel_5 IC lower alarm  68: channel_6 IA lower alarm  69: channel_6 IB lower alarm  70: channel_6 IC lower alarm  71: current lower alarm for any channel  72: PA lower alarm  73: PB lower alarm  74: PC lower alarm  75: total active power lower alarm  76: QA lower alarm  77: QB lower alarm  78: QC lower alarm  79: total reactive power lower alarm  80: SA lower alarm  81: SB lower alarm</p>
--	--	--	--

				82: SC lower alarm 83: total apparent power lower alarm 84: total power factor lower alarm 85: frequency lower alarm 86: DI1 open alarm 87: DI2 open alarm 88: DI3 open alarm 89: DI4 open alarm 90: DI5 open alarm 91: DI6 open alarm
0x4c7	DO1 Alarm value	Int	1	Secondary side electrical value
0x4c8	DO1 HYS	Int	1	Hysteresis value
0x4c9	DO2 mode	Int	1	Same as DO1 port
0x4ca	DO2 Act delay	Int	1	
0x4cb	DO2 Alarm data	Int	1	
0x4cc	DO2 Alarm value	Int	1	
0x4cd	DO2 HYS	Int	1	
0x4ce~ -0x4d7	reversed	Int	1	/
0x4d8	input net mode	Int	1	0: 3P4W 1: 3P3W 2CT 2: 3P3W 3CT
0x4d9	Voltage measure range	Int	1	0: 100V 1: 380V
0x4da	Current measure range	Int	1	0: 1A 1: 5A
0x4db	Voltage transformation ratio	Int	1	1-9999
0x4dc	Channel_1 CT ratio	Int	1	1-9999
0x4dd	Channel_2 CT ratio	Int	1	1-9999
0x4de	Channel_3 CT ratio	Int	1	1-9999
0x4df	Channel_4 CT ratio	Int	1	1-9999
0x4e0	Channel_5 CT ratio	Int	1	1-9999
0x4e1	Channel_6 CT ratio	Int	1	1-9999
0x4e2~ 0x4ed	Channel_7~18 CT ratio	Int	1	1-9999 (only for single phase type)
0xbb8	Clear energy counter	Int	1	Send code: 0x0A0A,

**Note:**

1. Not all of the data above can be read by RS485, the reading address will be unsuccessful
2. The data can be read out depends on your multi-function meter model, please refer to the corresponding product manual before build your software.
3. Some software has different definitions of the start bit of register address, there will be offset, please add 1 for the right address. To get more info, please contact technical support [tech@cqbluejay.com](mailto:tech@cqbluejay.com)

4. Blue Jay provide BOS1000 software for small measurement network and customer testing, it can connect max 32pcs of power meter, user can free to download this software on Blue Jay online site: [www.cqbluejay.com](http://www.cqbluejay.com)

### 8.4.- Example

Host to Slave inquiry

Addr	Fun	Data Address (high)	Data Address (low)	Data Number (high)	Data number (low)	CRC16 (low)	CRC16 (high)
0CH	03H	00H	00H	00H	06H	C4H	D5H

*PC user ask upload UA, UB, UC, IA, IB, IC*

Slave to Host answer

Addr	Fun	Byte count	Data1 high	Data1 low	Data2 high	Data2 low	Data3 high	Data3 low
0CH	03H	0CH	03H	E8H	03H	E9H	03H	E8H
Data4 high	Data4 low	Data5 high	Data5 low	Data6 high	Data6 low	CRC16 low	CRC16 high	
13H	84H	13H	88H	13H	8AH	A6H	D6H	

**Show the data:**

UA=3E8H (100.0)  
 UB=3E9H (100.1)  
 UC=3E7H (99.9)  
 IA=1384H (4.996)  
 IB=1388H (5.000)  
 IC=138AH (5.002)

**Notes:**

1. User can write register data for meter testing and remote control the meter
2. When the write is unsuccessful, no return data from the slave, in this addition, user can send write inquiry again

## 9. - SAFETY CONSIDERATIONS



All installation specification described at the previous chapters named:  
**INSTALLATION AND STARTUP, INSTALLATION MODES and SPECIFICATIONS.**

Note that with the instrument powered on, the terminals could be dangerous to touching and cover opening actions or elements removal may allow accessing dangerous parts. This instrument is factory-shipped at proper operation condition.

## 10. - MAINTENANCE

The MCM1000 does not require any special maintenance. No adjustment, maintenance or repairing action should be done when the instrument is open and powered on, should those actions are essential, high-qualified operators must perform them.

Before any adjustment, replacement, maintenance or repairing operation is carried out, the instrument must be disconnected from any power supply source.

When any protection failure is suspected to exist, the instrument must be immediately put out of service. The instrument's design allows a quick replacement in case of any failure.

For any inquiry about the instrument performance or any failure,  
contact to Blue Jay's technical service.

*Blue Jay - After-sales service*