

DEM-4M1D-2RS Single Phase Energy Meter

User Manual



Version: 1.10

Revision: 2026.02

Read me

When you use DEM-4M1D-2RS single phase energy meter, be sure to read this user manual carefully, and be able to fully understand the implications, the correct guidance of operations in accordance with user manual, which will help you make better use of DEM-4M1D-2RS single phase energy meter, and help to solve the various problems at the scene.

1. Before the meter turning on the power supply, be sure that the power supply within the provisions of the instrument;
2. When installation, the current input terminal must non-open, voltage input terminals must Non-short circuit;
3. Communication terminal (RS232/RS485) is strictly prohibited to impose on high pressure;
4. Be sure the instrument wiring consistent with the internal system settings;
5. When communicating with the PC, instrument communication parameters must be consistent with the PC.



- **Please read this user manual carefully**
- **Please save this document**

Directory

1.- SUMMARIZE	- 1 -
2.- TECHNICAL PARAMETERS	- 2 -
3.- INSTALLATION AND START-UP	- 3 -
3.1.- INSTALLATION	- 3 -
3.2.- CONNECTION TERMINAL	- 5 -
3.3.- TYPICAL WIRING	- 5 -
4.- SCREEN DISPLAY	- 6 -
4.1.- SCREEN DESCRIPTION	- 6 -
4.2.- INDICATOR LIGHT DESCRIPTION	- 6 -
4.3.- KEY FUNCTION DESCRIPTION	- 6 -
4.4.- SCREEN PAGES DESCRIPTION	- 7 -
5.- SETUP PROCEDURE	- 8 -
5.1.- Details of setting menu	- 8 -
5.2.- Description of menu characters	- 10 -
6.- PULSE OUTPUT	- 12 -
7.- COMMUNICATION INTERFACE	- 13 -
7.1.- CONNECTION FOR RS485	- 13 -
7.2.- MODBUS © PROTOCOL	- 14 -
7.3.- REGISTER MAP	- 15 -
7.4.- EXAMPLE	- 21 -
8.- SAFETY CONSIDERATIONS	- 22 -
9.- MAINTENANCE	- 22 -
10.- TECHNICAL SERVICE	- 23 -

1.- SUMMARIZE

DEM-4M1D-2RS single-phase rail-type electric energy meter is an intelligent device used in medium and low voltage systems (6-35KV and 0.4KV). It integrates data acquisition and control functions, adopts segment LCD screen, and has single-phase AC power measurement and calculation. Energy accumulation, RS485 communication and other functions.

DEM-4M1D-2RS single phase energy meter is 4M width single phase din rail energy meter, maximum load can directly have connected to 80A current. Built-in interfaces provide 1 channel pulse output and 2 channels RS485/ Modbus RTU communication.

Measurement Functions:

Voltage & current	power	Total reactive energy
Average voltage & current	Total & split-phase power factor	Multi-tariff (TOU)
Total & split-phase active power	System frequency	Demand record
Total & split-phase reactive	Total active energy	RTC

FEATURES

- 20(80)A direct access, 0.04A start current;
- Din-rail mounting 35mm, 4M width size;
- Measures and display KWh Kvarh, KW, PF, HZ, V, A, etc;
- Provide energy import and export measurement (IMP & EXP);
- Current & voltage accuracy is 0.5%;
- Active energy accuracy is class 1.0;
- Reactive energy accuracy is class 2.0;
- With 1* Energy pulse output, 3200imp/kwh;
- With 2* RS485 port, Modbus RTU protocol;
- With multi-tariff record (TOU), 3 tariff rates;
- Optional max demand and other parameters;

APPLICATIONS

- All power parameter measurement;
- Energy measurement and electrical fire monitor and control;
- Transformers, generators, capacitors and electric motors distributed detection;
- Medium and low voltage systems;
- SCADA, EMS, DCS integrators;

2.- TECHNICAL PARAMETERS

Measurement & Display

AUX Power	Single-phase voltage signal direct input: 85-265Vac, \leq 4VA
Voltage	Rated 220Vac RMS value, Accuracy 0.5%
Current	0.04-20(80)A, Direct access, Accuracy 0.5%
Current overload	Measurement: 1.2 times, Instantaneous: 10 times/1s
Voltage overload	Measurement: 1.2 times, Instantaneous: 2 times/10s
Frequency	40-65Hz, Accuracy \pm 0.01Hz
Active energy accuracy	Class 1.0, IEC 62053-22
Reactive energy accuracy	Class 2.0, IEC 62053-23
Display	LCD with white backlit
Maximum display value	99,999,999KWh

Other parameters

Communication	2 channels RS485, Modbus RTU
Pulse output port	1 channels pulse output, 3200imp/kWh
Multi- tariffs records	3 months energy data record, 4 set rates
Working environment	-10~55°C Altitude \leq 2000m, 0~93%RH, non-condensing, non-corrosive gas
Storage environment	-30~70°C
Withstand voltage	2kV AC RMS 1 minute, between input / output / case / power supply
Insulation	Input, output, power supply to the case $>$ 5M Ω

3.- INSTALLATION AND START-UP



The manual you hold in your hand contains information and warnings that the user should respect in order to guarantee a proper operation of all the instrument functions and keep it in safety conditions. The instrument must not be powered on and used until its definitive assembly is on the cabinet's door.

If the instrument is not used as manufacturer's specifications, the protection of the instrument will be damaged.

When any protection failure is suspected to exist (for example, it presents external visible damages), the instrument must be immediately powered off. In this case contact a qualified service representative.

3.1.- Installation

Mounting

Instrument is to be mounted on 35mm Din-rail. Keep all connections into the cabinet. Please note that with the instrument powered on, the terminals could be dangerous to touch and cover opening actions or elements removal may allow accessing dangerous parts. Therefore, the instrument must not be used until this is completely installed.

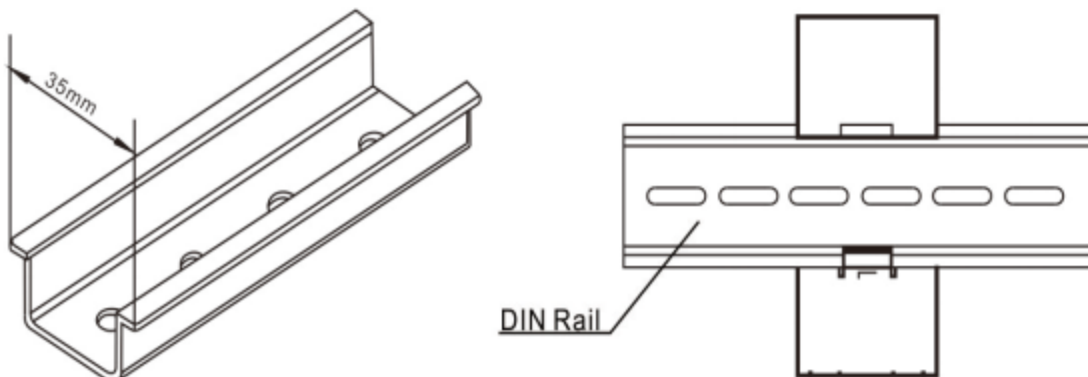

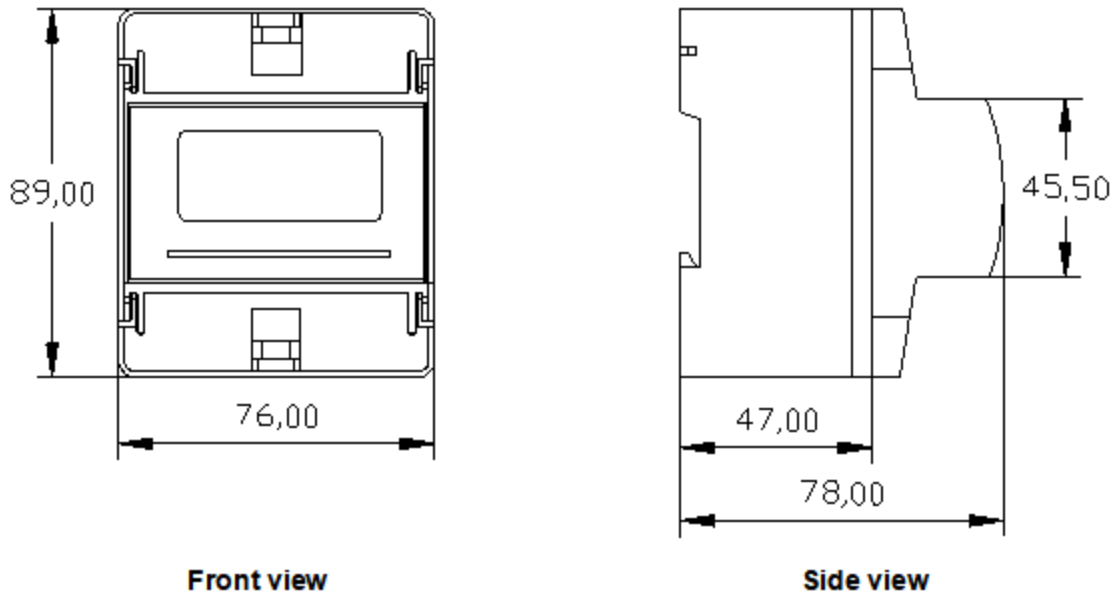
Dimension:**Unit: mm****Notes:**

Input signal: DEM-4M1D-2RS using a separate acquisition calculate for each measurement channel, to ensure consistent in use, for different load forms, it's a variety of connection mode. Access wire shall be met 3 square mm.

A. Voltage input

Input voltage should not exceed the rated input voltage products 450V. Otherwise, you should use external VT. Suggest 1A fuse be installed in the voltage input side.

B. Current Input

The meter adopts a direct connection type current input design, supporting rated current ranges of 0.04-20(80)A. The current is measured by directly passing the load current through the meter's internal current path, eliminating the need for external current transformers (CTs).

C. Auxiliary power

DEM-4M1D-2RS with universal (AC / DC) power input, if not for a special statement, we provide the 90-240AC/DC power interface for standard products, please ensure that the auxiliary power can match with meter to prevent unexpected damage.

A. Suggest install 1A fuse in the fire line side.

B. For the areas with poor power quality, suggest install lightning surge suppressor and rapid burst suppressor to prevent lightning strikes.

3.2.- Connection terminal

5	6	7	8	9	10
RS485-1		RS485-2		+	-

5-6: RS485-1 B, A

7-8: RS485-2 B, A

9-10: Active energy pulse output (+/-)

4	3	2	1
		N	L

1-2: Auxiliary power supply +/-

Note: The terminal pin definition may change depends on customer order; please refer to the label on the meter!

3.3.- Typical wiring

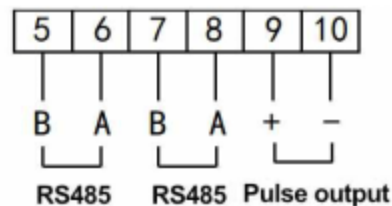
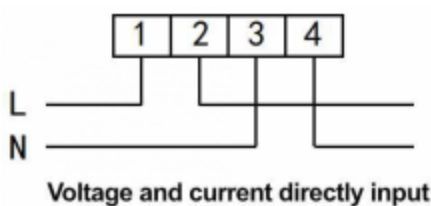

Note:

This connection drawing is for reference only; the actual connecting terminal please refer to the label on the rear part.

WARNINGS!

If power = -0.01 is shown for any of the phases and voltage and current are not zero for this phase, check out following points:

- Assure that A, B and C phases coincide in voltage and current.
- Correct polarity? Reverse the current transformer placed at this phase.



4.- SCREEN DISPLAY

4.1.- Screen description





- 1.- LED indicator
- 2.- Display measurement data
- 3.- Key Button









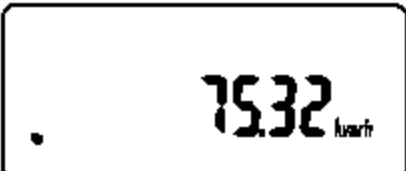

4.2.- Indicator light description

LED	Definition (when lighting)
	Active energy pulse output
	Reverse active energy (Export)

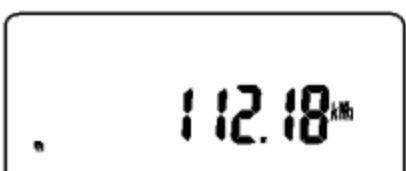
4.3.- Key function description

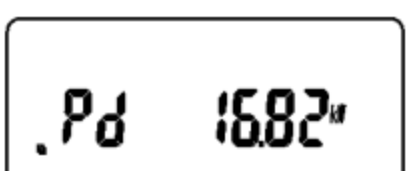
KEY	Function definition
	Short press is the left key to switch the measurement screen.
	Long press is the menu key to call out password screen and enter/ exit setting menu; Short press is the right key to switch the measurement screen;
	Long press is the confirmation key and to enter password 0001, and when exit setting menu to save the modified data.

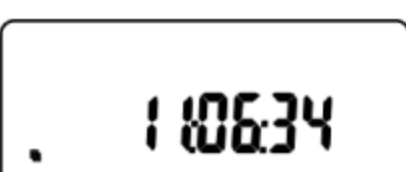
4.4.- Screen pages description

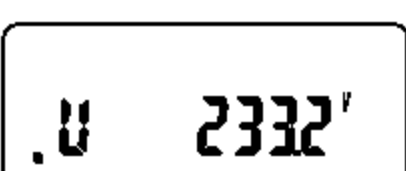
No.	Screen interface	Description
1		Present total positive active energy
2		Present total negative active energy
3		Present total positive reactive energy
4		Present total negative reactive energy
5		Active energy of multi tariff function Press  to view more details
6		Max demand function (optional) Press  to view more details
7		Real-time clock (RTC) Press  to view more details
8...		Show the measurement data U, I, P, Q, S, PF, Hz, RS485 info...

5.- SETUP PROCEDURE

In the case of measuring data, long press the "↻" key, and a prompt of "PASS" (that is, "password") will appear, short press the "↻" key to enter the password (default 0001), and long press the "↻" key to enter programming. In the status, the meter provides three menu items: system factory commissioning (SYS), input (-IN-), communication (bus), and additional other settings: time, meter reading day (E.day), rate (E.SEG).

5.1.- Details of setting menu

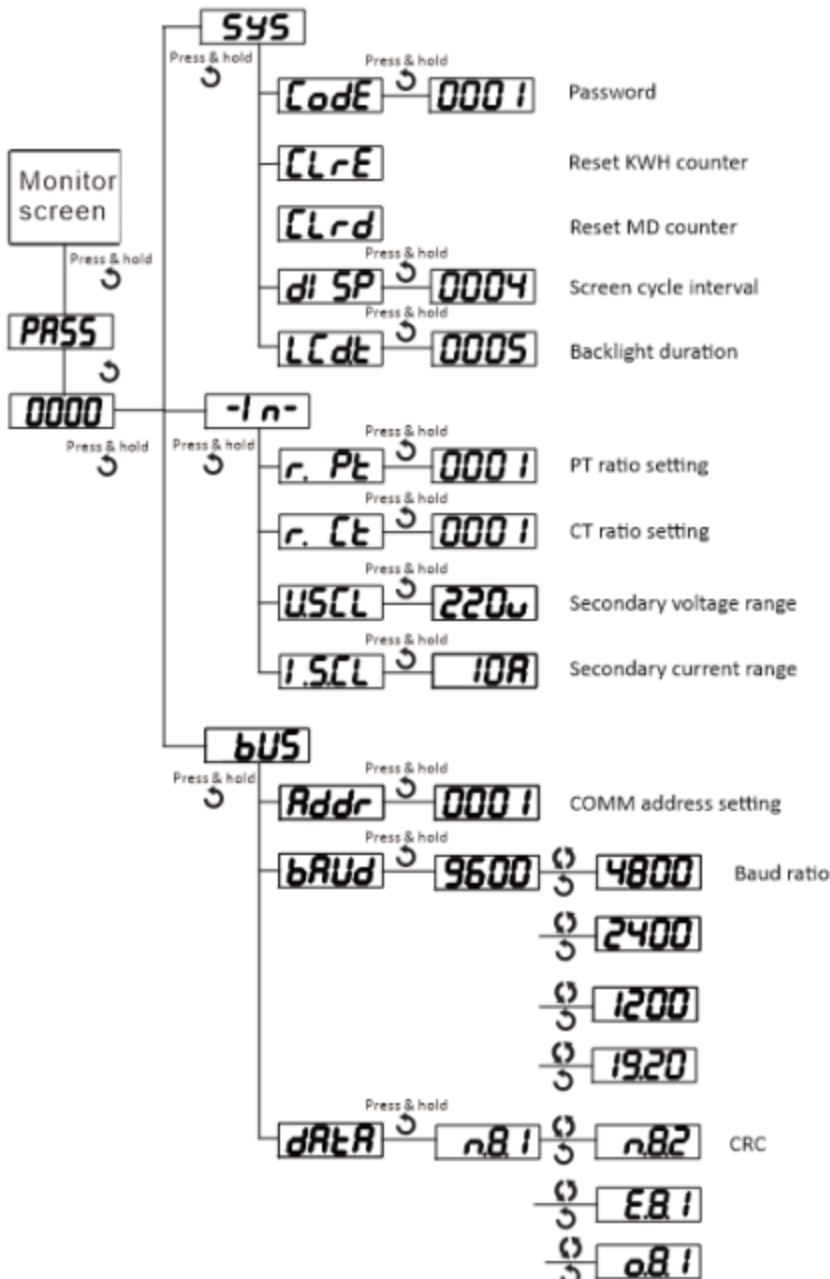

Time of use/multi-tariff setting: the meter supports four sets TOU tariff modes, supporting up to 12 programmable time segments for flexible billing structures:

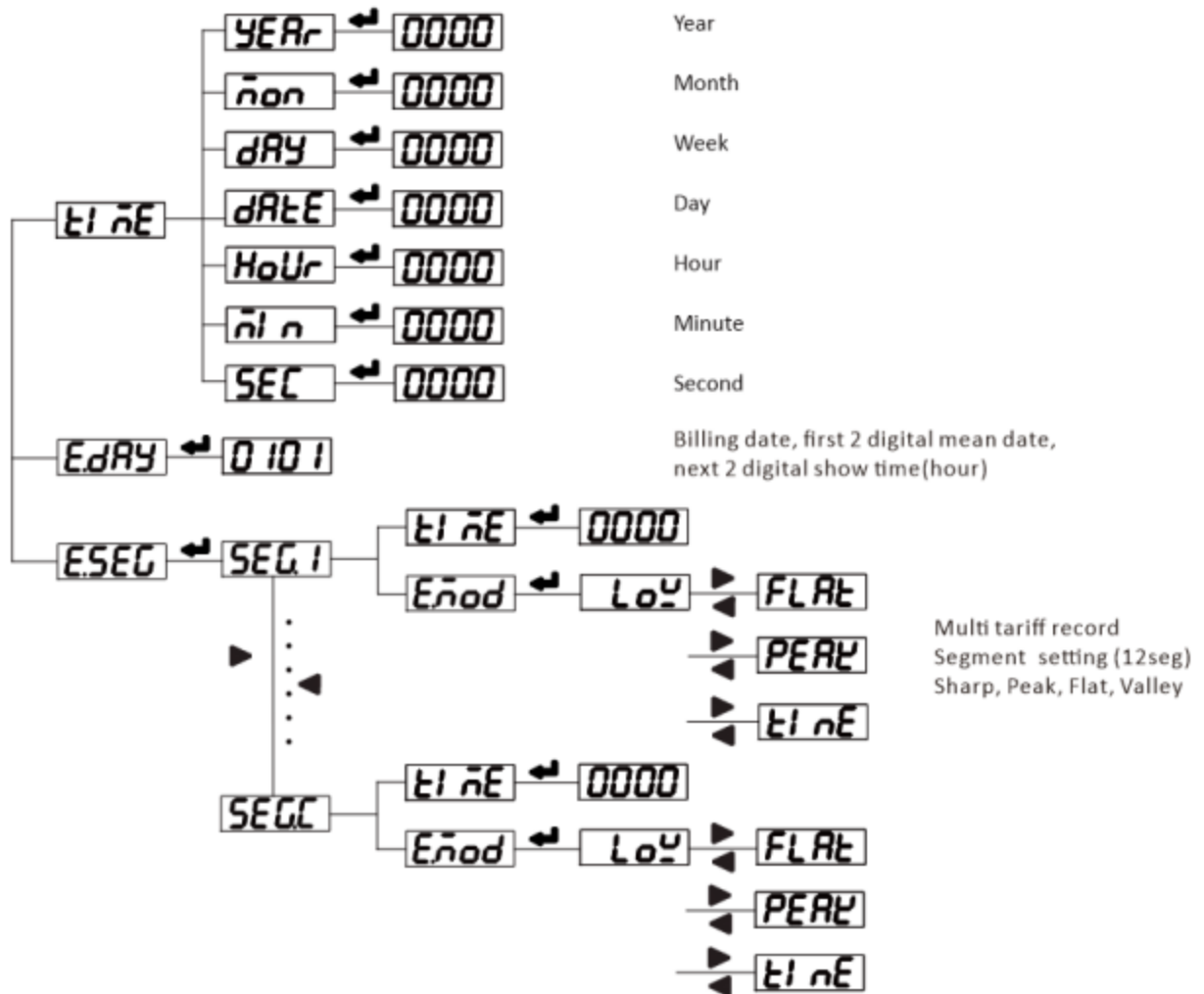

5.2.- Description of menu characters

PASS	(Password) User password
Erro	(Error) Wrong input information
-I n-	(Input) User Display data settings menu
bUS	(Bus) Communication settings menu
dAtA	(Data) Communication parameter setting
Addr	(Address) Local communication address setting
bAUd	(Baud) Communication baud rate
oB!	(o.8.1) Indicates 8 data bits, 1 stop bit, odd parity
EB!	(e.8.1) Indicates 8 data bits, 1 stop bit, even parity
nB!	(n.8.1) Indicates 8 data bits, 1 stop bit, no parity bit
USCL	(U.scl) Select rated input voltage
ISCL	(I.scl) Select rated input current
r. Ct	(R.ct) Set the current multiplier
r. Pt	(R.pt) Set voltage ratio
SYS	(System) System settings menu (for factory debugging, not open yet)
tYPE	(Type) What parameters to set
PARA	(Para Corresponding parameter selection

VALU	(Value) Set the corresponding alarm value
Code	(Code) Modify password value
YEAR	(Year) Set year
mon	(Month) Set month
DAY	(Day) Set day
DATE	(Date) Set date
Hour	(Hour) Set hour
min	(Min.) Set minute
SEC	(Second) Set second
ESEG	(Seg.) Set segment
Emod	Rate mode
FLAT	Flat
LOW	Valley
LINE	Sharp
PEAK	Peak
EDAY	Meter reading time setting

6.- PULSE OUTPUT

DEM-4M1D-2RS provides 1* pulse output for active energy.

The host / PLC / DI module can cumulative the data of both the active and reactive power energy sent by the pulse from opt coupler relay.

1). Electrical specification: voltage $VCC \leq 48V$, $I_z \leq 50mA$.

2). Pulse: 3200imp / kWh, pulse up to 80ms.

This means: When the device detects 1 kWh, the port will generate 3200 pulses

Note:

1 kWh energy is for secondary side energy data, if there have PT and CT accessed; primary side energy data is "1 kWh \times PT ratio \times CT ratio".

7.- COMMUNICATION INTERFACE

7.1.- Connection for RS485

The composition of the RS-485 cabling must be carried out with a meshed screen cable (minimum 3 wire), diameter of not less than 0.5mm², with a maximum distance of 1,200 m between the DEM-4M1D-2RS... and the master unit. This Bus may connect a maximum of 32pcs.

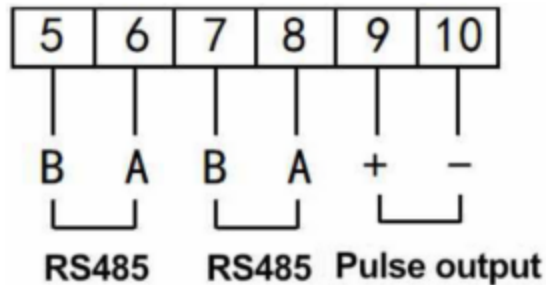

Notes:

- For communication with the master unit, user can choose RS-485 to RS-232 converter or RS485 to USB adapter to use.
- For expand the number of devices in the communication network, a signal repeater can be used.
- Due to product modifications or special requirements, the interface pin place may be change. For details, please refer to product label on the rear side

7.2.- MODBUS © Protocol

Modbus RTU Frame Format:

Address code	1 BYTE	<i>Slave device address 1-247</i>
Function code	1 BYTE	<i>Indicates the function codes like read coils / inputs</i>
Data code	4 BYTE	<i>Starting address, high byte Starting address, low byte Number of registers, high byte Number of registers, low byte</i>
Error Check code	2 BYTE	<i>Cyclical Redundancy Check (CRC)</i>

MODBUS FUNCTIONS:

Code	Meaning	Description
FUNCTION 03	Read Holding Registers	<i>Read the binary contents of holding registers in the slave</i>
FUNCTION 04	Read Input Registers	<i>Read the binary contents of input registers in the slave.</i>
FUNCTION 06	Write Single Register	<i>Writes a value into a single holding register.</i>
FUNCTION 10	Write Multiple Registers	<i>Writes values into a sequence of holding registers</i>

Note: Float data follow **IEEE754**, float low bit first, high bit next. **(CD AB)**

7.3.- Register Map

7.3.1.- Basic power data-Primary Side

Register	Data	Byte mode		Definition
0x00	U	float	2	Phase to line voltage, unit: V
0x0c	I	float	2	Current, unit: A
0x12	P	float	2	Active power, unit: kw
0x1a	Q	float	2	Reactive power, unit: kvar
0x22	S	float	2	Apparent power, unit: kva
0x2a	PF	float	2	Power factor, 0~1.000
0x32	FR	float	2	Frequency, unit:0.01Hz
0x34	Ep+	float	2	Positive active energy, Unit: kWh
0x36	Ep-	float	2	Negative active energy, Unit: kWh
0x38	Eq+	float	2	Inductive reactive power, Unit: kVarh
0x3a	Eq-	float	2	Capacitive reactive power

7.3.2.- Advanced electrical parameter- Max demand record

Register	Data	Byte mode		Instruction
0x300	Pd	float	2	Present active power demand, Unit: W
0x302	Qd	float	2	Present reactive power demand, Unit: var
0x304	Sd	float	2	Present apparent power demand, Unit: VA
0x306	Pd_M0	float	2	Maximum active power demand in present month
0x308	Qd_M0	float	2	Maximum reactive power demand in present month
0x30a	Sd_M0	float	2	Maximum apparent power demand in present month
0x30c	Pd_M1	float	2	Maximum active power demand in last month
0x30e	Qd_M1	float	2	Maximum reactive power demand in last month
0x310	Sd_M1	float	2	Maximum apparent power demand in last month
0x312	Pd_M2	float	2	Maximum active power demand in month before last month
0x314	Qd_M2	float	2	Maximum reactive power demand in month before last month
0x316	Sd_M2	float	2	Maximum apparent power demand in month before last month
0x318-0x31F		float	2	Reserved

M0: Present month

M1: Last month

M2: Month before last month

Pd: Maximum active power demand

Qd: Maximum reactive power demand

Sd: Maximum apparent power demand

7.3.3.- Tou/ Multi- tariffs ratio data

Register	Data	Byte mode		Instruction
0x400	E0_Tol	long	2	Total cumulative energy
0x402	E0_T1	long	2	T1-T4 cumulative Energy record
0x404	E0_T2	long	2	
0x406	E0_T3	long	2	
0x408	E0_T4	long	2	
0x40a	E1_Tol	long	2	Total energy of present month
0x40c	E1_T1	long	2	T1-T4 energy record of present month
0x40e	E1_T2	long	2	
0x410	E1_T3	long	2	
0x412	E1_T4	long	2	
0x414	E2_Tol	long	2	Total energy of last month
0x416	E2_T1	long	2	T1-T4 energy record of last month
0x418	E2_T2	long	2	
0x41a	E2_T3	long	2	
0x41c	E2_T4	long	2	
0x41e	E3_Tol	long	2	Total energy of the month before last month
0x420	E3_T1	long	2	T1-T4 energy record the month before last month
0x422	E3_T2	long	2	
0x424	E3_T3	long	2	
0x426	E3_T4	long	2	

E0: E1+E2+E3 total cumulative energy

E1: Present month

E2: Last month

E3: Month before last month

T1: TOU mode-1

T2: TOU mode-2

T3: TOU mode-3

T4: TOU mode-4

7.3.4.- Configuration menu (Function 03 to Read & Function 06/10 to Write)

Register	Data	Byte mode		Instruction
0x20A	RTC. year	int	1	Internal RTC real-time time: year-month-date-hour-minute-second-day
0x20B	RTC. month	int	1	
0x20C	RTC. date	int	1	
0x20D	RTC. hour	int	1	
0x20E	RTC. minute	int	1	
0x20F	RTC. second	int	1	
0x210	RTC. day	int	1	
0x214	RS485 address	int	1	1-247
0x215	Baud rate	int	1	0: 1200; 1: 2400; 2: 4800 3: 9600; 4: 19200
0x216	Data format	int	1	0: n.8.1; 1: o.8.1 2: e.8.1; 3: n.8.2
0x217	Meter reading time	int	1	Bits 7-0: hour (0-23) Bits15-8: date (1-28)
0x218	Rate mode 1 - seg. 1	int	1	0: T1(sharp); 1: T2(peak) 2: T3 (flat); 3: T4 (valley)
0x219	Rate mode 1 - seg. 2	int	1	
0x21A	Rate mode 1 - seg. 3	int	1	
0x21B	Rate mode 1 - seg. 4	int	1	
0x21C	Rate mode 1 - seg. 5	int	1	
0x21D	Rate mode 1 - seg. 6	int	1	
0x21E	Rate mode 1 - seg. 7	int	1	
0x21F	Rate mode 1 - seg. 8	int	1	
0x220	Rate mode 1 - seg. 9	int	1	
0x221	Rate mode 1 - seg. 10	int	1	
0x222	Rate mode 1 - seg. 11	int	1	
0x223	Rate mode 1 - seg. 12	int	1	
0x224	Meter reading time of rate mode 1 - seg. 1	int	1	Bits 7-0: minute (0-59) Bits 15-8: hour (0-23)
0x225	Meter reading time of rate mode 1 - seg. 2	int	1	

0x226	Meter reading time of rate mode 1 - seg. 3	int	1	
0x227	Meter reading time of rate mode 1 - seg. 4	int	1	
0x228	Meter reading time of rate mode 1 - seg. 5	int	1	
0x229	Meter reading time of rate mode 1 - seg. 6	int	1	
0x22A	Meter reading time of rate mode 1 - seg. 7	int	1	
0x22B	Meter reading time of rate mode 1 - seg. 8	int	1	
0x22C	Meter reading time of rate mode 1 - seg. 9	int	1	
0x22D	Meter reading time of rate mode 1 - seg. 10	int	1	
0x22E	Meter reading time of rate mode 1 - seg. 11	int	1	
0x22F	Meter reading time of rate mode 1 - seg. 12	int	1	
0x230-0x247	Rate mode 2 setting	int	1	
0x248-0x25f	Rate mode 3 setting	int	1	The same as rate mode 1 setting
0x260-0x277	Rate mode 4 setting	int	1	
0x278	January rate mode setting	int	1	
0x279	February rate mode setting	int	1	
0x27a	March rate mode setting	int	1	
0x27b	April rate mode setting	int	1	
0x27c	May rate mode setting	int	1	
0x27d	June rate mode setting	int	1	
0x27e	July rate mode setting	int	1	
0x27f	August rate mode setting	int	1	
0x280	September rate mode setting	int	1	
0x281	October rate mode	int	1	

	setting			
0x282	November rate mode setting	int	1	
0x283	December rate mode setting	int	1	
/				
0x1000	Reset energy	int	1	Write 0x0A0A, (Dec.2570) for reset
0x1001	Reset demand	int	1	
0x1002	Reset SOE	int	1	

Notes:

1. Not all data above can be read by RS485
2. Whether the data can be read out or not depends on your meter model, please refer to the corresponding product manual before build your software.
3. Some software have different definitions of the start bit of register address, there will be offset, please add 1 for the right address. To get more info, please contact technical support tech@cqbluejay.com

7.4.- Example

Host inquiry slave device

Addr.	Func.	Data Address (high)	Data Address (low)	Data Number (high)	Data number (low)	CRC16 (low)	CRC16 (high)
0CH	03H	00H	00H	00H	06H	C4H	D5H

PC users are asked to upload UA, UB, UC, IA, IB, IC

Slave device answer

Addr.	Func.	Byte count	Data1 high	Data1 low	Data2 high	Data2 low	Data3 high	Data3 low
0CH	03H	0CH	03H	E8H	03H	E9H	03H	E8H
Data4 high	Data4 low	Data5 high	Data5 low	Data6 high	Data6 low	CRC16 low	CRC16 high	
13H	84H	13H	88H	13H	8AH	A6H	D6H	

Show the data:

UA=3E8H (100.0)

UB=3E9H (100.1)

UC=3E7H (99.9)

IA=1384H (4.996)

IB=1388H (5.000)

IC=138AH (5.002)

Notes:

1. Blue Jay disable the 06 function in default setting, if Activated the write command, please check the host device program to avoid the meaningless write operation, that may reduce the reduce the register working life.
2. When the write is unsuccessful, no return data from the slave device. In this addition, please re-send write inquiry again.

8.- SAFETY CONSIDERATIONS



All installation specification described at the previous chapters named: **INSTALLATION AND STARTUP, INSTALLATION MODES and SPECIFICATIONS.**

Please note that with the instrument powered on, the terminals could be dangerous to touching and cover opening actions or elements removal may allow accessing dangerous parts. This instrument is factory-shipped at proper operation condition.

- ◆ The device must have a professional installation and maintenance
- ◆ Any operation of the device, you must cut off the input signal and power;

9.- MAINTENANCE

The DEM-4M1D-2RS single phase energy meter does not require any special maintenance. No adjustment, maintenance or repairing action should be done when the instrument is open and powered on, should those actions are essential, high-qualified operators must perform them.

Before any adjustment, replacement, maintenance or repairing operation is carried out, the instrument must be disconnected from any power supply source.

When any protection failure is suspected to exist, the instrument must be immediately put out of service. The instrument's design allows a quick replacement in case of any failure.

10.- TECHNICAL SERVICE

FAQ's

- 1.- Once cabled and connected is seen to give a correct voltage and current reading, but shows negative values for active power (generation).

This is an error with the cabling for the current transformer secondary; the direction of the transformer current has to be respected as shown in the connection diagram. The current transformers have a two face primary; the current must pass from P1 to P2 giving the result in secondary (S1 and S2) of 5 amps.

The error stems from:

- a). The current transformers have been incorrectly installed. As a result, it gives the direction of the current as passing from P2 to P1; to resolve this problem, the current transformer does not have to be dismantled and installed again, but the transformer secondary (S1 and S2) just has to be inverted.
 - b). The connection of the current secondary in the current transformers have been incorrectly connected; to resolve this problem just connect the S1 transformer secondary to the S1 on the meter and the S2 on the current transformer to the S2 on the meter.
- 2.- Once cabled and connected, is seen to give an incoherent Power factor and Cos Φ reading (-0.01 or similar).

This is again a current transformer and voltage phase connection error phase A, must correspond to the current transformer installed in phase A; phase B, must correspond to the current transformer installed in phase B; and phase C, must correspond to the current transformer installed in phase C.

This connection terminal is clearly shown on the area side of the device.

- 3.- The measuring voltage and is displaying the secondary voltage (for example 110 volts). Ensure that the voltage Transformer ratio has been correctly set.
- 4.- Device does not correctly display the current reading. It shows values varying between 0 to 5 amps of current. Ensure that the Current Transformer ratio has been correctly set.

Calculation formula of electrical parameter

Formula	Parameter
$U = \sqrt{\frac{1}{N} \sum_{n=0}^N u_n^2} \quad n = 0, 1, 2, \dots, N$	Voltage RMS value
$I = \sqrt{\frac{1}{N} \sum_{n=0}^N i_n^2} \quad n = 0, 1, 2, \dots, N$	Current RMS value
$P = \frac{1}{N} \sum_{n=1}^N (i_{an} u_{an} + i_{bn} u_{bn} + i_{cn} u_{cn})$	Total active power cycle average
$P_s = UI$	Single-phase apparent power cycle average
$\cos \theta = \frac{P_p}{P_s}$	Power factor
$P_q = \sqrt{P_s^2 - P_p^2}$	Reactive power (Pq is positive and the direction cannot be determined; P algorithm can be used to shift the voltage component by 90°)
$W = \int P * dt$	Electric energy

Note: In above formula, N for sampling points in one AC wave.

For any inquiry about the instrument performance or any failure, contact to Blue Jay's technical service.

Blue Jay - After-sales service

E-mail: tech@cqbluejay.com