

BJ-194Q

Multi-Function Power Analyzer

User Manual



Version: 4.44

Read me

When you use BJ-194... series multi-function meter, be sure to read this user manual carefully, and be able to fully understand the implications, the correct guidance of operations in accordance with user manual, which will help you make better use of BJ-194... series multi-function meter, and help to solve various problems at the scene.

1. Before the meter turns on the power supply, be sure that the power supply is within the provisions of the instrument;
2. When installation, the current input terminal must be non-open, and voltage input terminals must be Non-short circuit;
3. Communication terminal (RS232/RS485 or Ethernet) is strictly prohibited to impose on high pressure;
4. Be sure the instrument wiring is consistent with the internal system settings;
5. When communicating with the PC, instrument communication parameters must be consistent with the PC.



- **Please read this user manual carefully**
- **Please save this document**

Directory

1. - SUMMARIZE	- 4 -
2. - FEATURES.....	- 6 -
2.1. - ELECTRICITY METERING.....	- 6 -
2.2. TECHNICAL PARAMETERS.....	- 7 -
-INPUT VOLTAGE.....	- 7 -
3. - INSTALLATION AND START-UP	- 9 -
3.1. - INSTALLATION	- 9 -
3.2. - CONNECTION TERMINAL.....	- 12 -
3.3. – TYPICAL CONNECTION DRAWING	- 13 -
4. - OPERATION MODE.....	- 14 -
5. SCREEN DISPLAY	- 15 -
5.1.-OVERALL OF THE SCREEN PAGES	- 15 -
6. - SETUP PROCEDURE	- 16 -
6.1.- MAIN CONFIGURATION MENU	- 16 -
6.2.- INPUT SETTING.....	- 17 -
6.3.- COMMUNICATION PORT SETTING	- 18 -
6.4.- ALARM SETTING	- 19 -
6.4.1.- Alarm setting description.....	- 20 -
6.4.2.- Delay & Hysteresis operation logic	- 21 -
6.5.- RELAY SETTING (OPTIONAL DO PORT)	- 22 -
6.5.1.- Relay setting description.....	- 23 -
6.5.2.- Remote mode operation	- 23 -
6.6.- ANALOG OUTPUT SETTING (OPTIONAL AO PORT)	- 24 -
6.6.1.- Analog output setting.....	- 25 -
6.7.- SYSTEM SETTING	- 26 -
6.8.- RTC SETTING (REAL TIME CLOCK)	- 27 -
6.9.- TOU SETTING (TIME OF USE / MULTI TARIFF RECORD).....	- 28 -
6.10.- OTHER PORTS	- 29 -
6.10.1.- Pulse output port	- 29 -
6.10.2.- Digital input port (Optional DI port)	- 30 -
7. - DATA LOG FUNCTION.....	- 31 -
7.1.- DATE LOGGER (OPTIONAL).....	- 33 -
8.- COMMUNICATION INTERFACE	- 35 -
8.1.- CONNECTION FOR RS485 BUS	- 35 -
8.2.- MODBUS © PROTOCOL	- 36 -
8.3. - Register Map.....	- 37 -

8.3.1- Basic power data—Primary Side	- 37 -
8.3.2 - Basic power data—Secondary Side.....	- 38 -
8.3.3- Meter status data.....	- 39 -
8.3.4- Advanced electrical parameter	- 39 -
8.3.5- Multi- tariffs ratio data.....	- 41 -
8.3.6- THD and individual harmonic (Max 62 times).....	- 42 -
8.3.7- SOE record (20lists record for I/O port trig, 80 lists record for Alarm-X trig).....	- 43 -
8.3.8 - Write operation function definition: Preset Single holding register	- 44 -
8.4.- EXAMPLE	- 45 -
9. - SAFETY CONSIDERATIONS	- 46 -
10. - MAINTENANCE	- 46 -
11. - TECHNICAL SERVICE	- 47 -

1. - SUMMARIZE

BJ-194Q-9SY Multi-Function Power Analyzer is a high-end multifunction power meter. It is the ideal choice for monitoring and measuring power systems. Using dot matrix LCD screen, can more easily display more electrical parameters on the same screen. With higher measurement accuracy, and powerful functions. The device provides a communication interface to connect with the computer monitoring system, and supports RS485 interface MODBUS communication protocol.

It can measure all power parameters in power grid:

Current,	Energy (Active/Reactive),	Max demand,
Voltage,	Power factor	Harmonics factor,
Frequency,	Multi- tariffs ratio	Voltage crest factor,
Active power,	Current harmonics 2~63 times,	Current K-factor,
Reactive power,	Voltage harmonics 2~63 times,	Voltage drop,
Apparent power,	Voltage and current THD%,	Voltage flicker.
Analog output	Relay output	Unbalance
Alarm record		

With optional expansion modules, it can also transmit the parameter into 2*Relay output (Can expand to 4 DO) and 8*Switch input (6DI), 3*Analog output (3AO). It is suitable for transformers, generators, capacitor banks and motors of the distributed detection, automatic control system, on-line monitoring display. BJ-194Q provides max 100 lists event logging, storage DI/DO acted events in real-time, also the logging function for event tracing is optional.

It can replace the traditional analog of many digital measurement instruments (such as ammeter, voltmeter, power meter, power factor meter, frequency meter, etc.). The integrated advanced electrical parameter and logging function can replace the general power recorder to perform real-time online monitoring, with the advantages of improving system reliability, making the on-site wiring convenient and reducing system cost.

With serial port, BJ-194Q can connect with PC; and use Modbus to set programming and read the data. Based on this power meter, you can simply set up a monitoring system with the IPC and central software.

APPLICATIONS

- All power parameter measurement;
- Energy Measurement and electrical fire monitor and control;
- Replacing the three-phase power meter, three phase electricity transmitter;
- Transformers, generators, capacitors and electric motors distributed detection;
- Medium and low pressure systems;
- SCADA, EMS, DCS integrators.

2. - FEATURES

2.1. - Electricity Metering

By means of an internal microprocessor it simultaneously measures:

Parameter	Symbol	A-phase	B-phase	C-phase	Total
Single phase voltage	V	√	√	√	/
*Phase-phase voltage	V	√	√	√	/
Current	A	√	√	√	/
Frequency	Hz	/	/	/	√
Power factor	COSΦ	√	√	√	√
Apparent power	VA	√	√	√	√
Active power	W	√	√	√	√
Reactive power	Var	√	√	√	√
Apparent power	VA	√	√	√	√
Active energy	Wh	√	√	√	√
Reactive energy	Varh	√	√	√	√
Multi- tariffs energy record	Wh	/	/	/	√
Max demand (W / Var / VA)	MAX	/	/	/	√
Voltage / frequency deviation	---	√	√	√	/
Voltage / current unbalance	---	/	/	/	√
THD & Harmonic (2~63 th)	---	√	√	√	√

√: Display and communications.

Note: Phase-phase voltage is Uab, Ubc, Uca, voltage data determined by the different wiring

The BJ-194Q delivers the visualization of parameters listed above by means of 3.0" dot matrix LCD screen. Multiple electrical parameters are shown in total 18 main screens, folded some parameter in sub-screen. Also the screen can display the phase angle and harmonic histogram to facilitate the on-site personnel to intuitively understand the electric-grid status.

OTHER FEATURES

- Small size (96 x 96 mm), panel-mounting meter, length of instrument is 75mm (including terminals)
- True R.M.S. measuring system.
- Instantaneous, maximum and minimum values of each measured parameter.
- Energy measurement (indication through a lighting led)
- With positive/negative energy measurement
- RS-485 or Ethernet (optional) type communication to a PC.

2.2. Technical parameters

-Input voltage

Rated:	AC100V, 220V, 380V (Confirmed before order)
Overload:	Continues: 1.2times, Instantaneous: 2times/10s
Accuracy:	0.5s, RMS
Impedance:	>1MΩ
Network:	1P2W / 3P3W / 3P4W
Frequency:	40~65Hz, ±0.02Hz
Active energy:	0.2W
Reactive energy:	1.0W
Burned:	<0.1VA (per-phase)

-Input current

Rated:	AC... /1A or .../5A (Confirmed before order)
Overload:	Continues: 1.2times; Instantaneous: 10times /1s
Accuracy:	0.2s, RMS
Impedance:	>1MΩ
Burned:	<0.4VA (per-phase)

- Output

Digital interface:	RS485, MODBUS-RTU
Pulse output:	2 channels energy pulse
Alarm record:	5 different alarm record

-Auxiliary power supply

Working range:	90V~240V AC/DC
Burned:	≤4VA

- Environment

Working temperature:	-10°C ~ 55°C
Storage temperature:	-30°C ~70°C
Relative humidity:	93% (Non- condensing, Non-corrosive gas)

- Insulation

Input to power >2kV
Input to output >2kV
AUX to output >2kV

- Deviation

Voltage deviation: 0.2%
Frequency deviation: 0.02%

- Digital input

4*DI (max 6*DI), Dry contact
Ri<500Ω trig, Ri>100kΩ disconnect

- Digital output (optional)

2 relay outputs
Relay capacity: 5A/250VAC & 5A/30VDC

- Analog output (optional)

Current 4~20A, load<390Ω;
Voltage 0~10V, load>100kΩ

- Other parameters

Power: 0.2S
Energy: Active energy (0.2S), Reactive energy (1.0)
Screen: 3.0 inch Dot matrix LCD (Resolution 192x160)
SOE: Cyclic storage 20 lists I/O event and 80 lists alarm record
Unbalance: Voltage: 0.2% Current: 0.2%
Individual harmonic: Uh>2%: 5%Uh, Uh<=2%: 0.1%UN

-Dimension

96(W) X 96(H) X 75(D) mm

3. - INSTALLATION AND START-UP



The manual you hold contains information and warnings that users should comply with in order to guarantee proper operation of all the instrument functions and keep it in safety conditions. The instrument must not be powered on and used until its definitive assembly is on the cabinet's door.

If the instrument is not used as manufacturer's specifications, the protection of the instrument will be damaged.

When any protection failure is suspected to exist (for example, it presents external visible damages), the instrument must be immediately powered off. In this case contact a qualified service representative.

3.1. - Installation

Mounting

Instrument is to be mounted on panel (cut-out 91+0.8mm x 91+0.8 mm). Keep all connections into the cabinet.

Note that with the instrument powered on, the terminals could be dangerous to touch and cover opening actions or elements removal may allow accessing dangerous parts. Therefore, the instrument must not be used until it is completely installed.

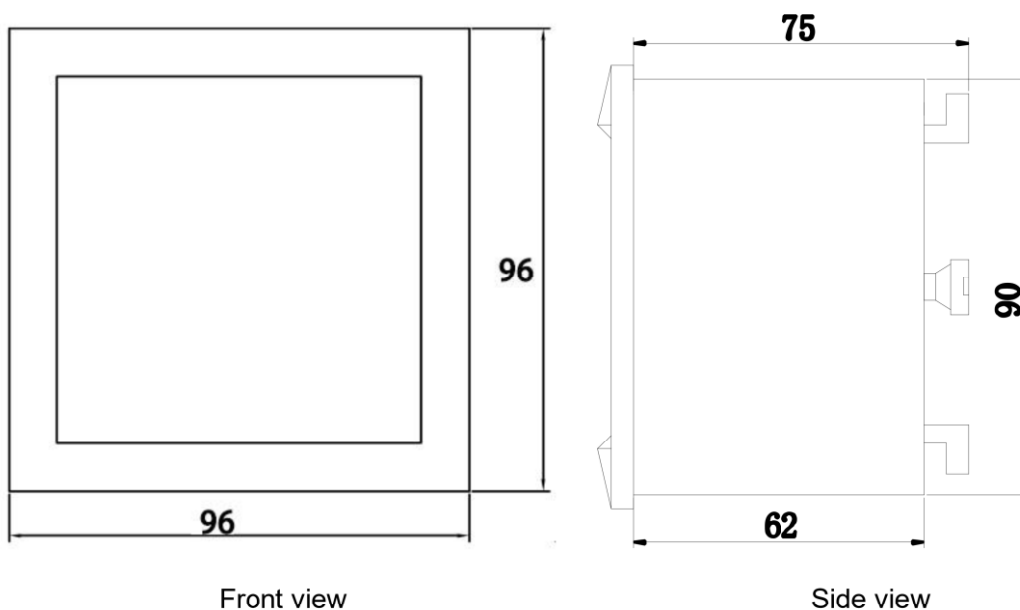

Notes:

Input signal: BJ194Q using a separate acquisition calculate for each measurement channel, to ensure consistent in use, for different load forms, it's a variety of connection mode. Access wire shall be met 2.5 square mm.

A. Voltage input

Input voltage should not exceed the rated input voltage products 450V, Otherwise, you should use external VT. Suggest 1A fuse be installed in the voltage input side.

B. Current Input

Standard input current is 5A or 1A, if greater than 5A/1A should use external CT. When the CT is connected with other meters, make sure wiring methods be used in series.

Warning: Forbid to install a CT on the live feeder wire with open secondary leads. This can be extremely dangerous!

Before remove the current input connection, must be sure to disconnect the primary circuit or shorted secondary circuit of CT.

C. Sequence of wire

Warning: Please make sure that the input voltage and current corresponding to the same phase, sequence, and the same direction; Otherwise, the Values and symbols will be wrong! (Power and Energy)

Always observe the physical orientation of CT (P1 - P2) when installing on the feeder wire. Always pay attention to wiring polarity and phasing when terminating the CT leads to the BJ194J. S1 connect to Ix*, S2 connect to Ix.

The input network configuration of instrument depends on the CT number of the system:
in the condition of 2 CT, select the three-phase, three-lines two components;
in the condition of 3 CT, select the three-phase, four-lines three component mode.

Instrument connection mode, set of the instrument (programming input network NET) should be the same load wiring as measured wiring. Otherwise, the measurement instrument will lead to incorrect voltage or power.

In three-phase 3 wire mode, measurement and shows the line voltage;

In three-phase 4 wire mode, measurement and shows the phase voltage and line voltage both.

D. Auxiliary power

BJ194Q Series with universal (AC / DC) power input, if not for a special statement, we provide the 90-240AC/DC power interface for standard products, please ensure that the auxiliary power can match with meter to prevent unexpected damage.

- A. Suggest install 1A fuse in the fire line side.
- B. For the areas with poor power quality, suggest install lightning surge suppressor and rapid burst suppressor to prevent lightning strikes.

3.2. - Connection Terminal

Upper connection terminal

15	16	50	49	48	47	60	59	58	1	2
AO-	AO+	RP-	RP+	AP-	AP+	GND	RS485B	RS485A	Power supply	

- | | |
|--------------------------------------|------------------------------------|
| 16. Analog output (+) | 1. *Supply voltage input: 0 V |
| 15. Analog output (-) | 2. *Supply voltage input: 220 Vac. |
| 47. Active energy pulse output (+) | 58. RS-485 (+) |
| 48. Active energy pulse output (-) | 59. RS-485 (-) |
| 49. Reactive energy pulse output (+) | 60. RS-485 (GND) |
| 50. Reactive energy pulse output (-) | |

Middle connection terminal

70	71	72	73	74	75	76		19	20	21	22	23	24
COM	DI1+	DI2+	DI3+	DI4+	DI5+	DI6+		DO1		DO2		DO3	

- | | |
|-------------------------------|--------------------------------|
| 70. Digital input COM pin | 20. Route 1 digital output (+) |
| 71. Route 1 digital input (+) | 19. Route 1 digital output (-) |
| 72. Route 2 digital input (+) | 22. Route 2 digital output (+) |
| 73. Route 3 digital input (+) | 21. Route 2 digital output (-) |
| 74. Route 4 digital input (+) | 24. Route 3 digital output (+) |
| 75. Route 5 digital input (+) | 23. Route 3 digital output (-) |
| 76. Route 6 digital input (+) | |

Lower connection terminal

14	13	12	11	9	8	7	6	5	4
Un	Uc	Ub	Ua	C-phase Current		B-phase Current		A-phase Current	

- | | |
|---------------------------|-------------------------------|
| 11. Voltage A-phase input | 4. Current A-phase - S1 input |
| 12. Voltage B-phase input | 5. Current A-phase - S2 input |
| 13. Voltage C-phase input | 6. Current B-phase - S1 input |
| 14. Neutral Voltage input | 7. Current B-phase - S2 input |
| | 8. Current C-phase - S1 input |
| | 9. Current C-phase - S2 input |

Note:

The terminal pin will change depends on special order requirement; please refer to the sticker on the meter!

3.3. – Typical Connection Drawing

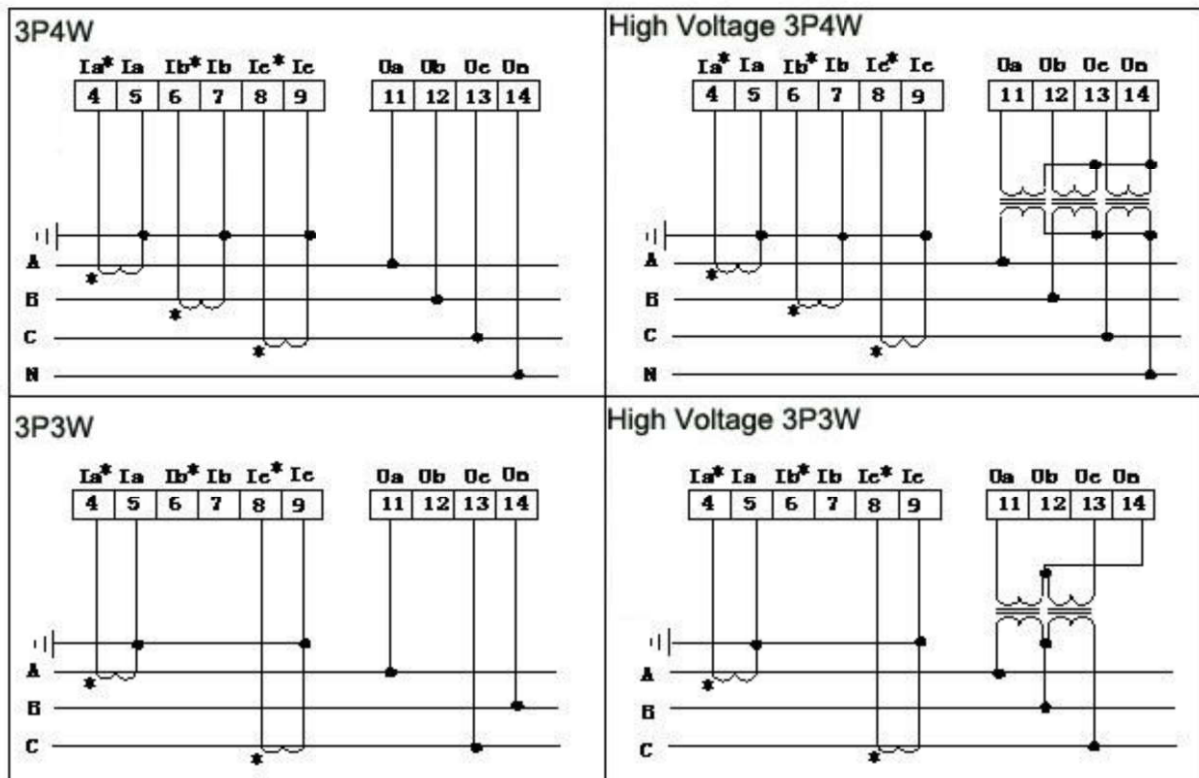

Note:

This connection drawing is for reference only; the actual connecting terminal please refer to the label on the rear part.





WARNINGS!

If power = -0.01 is shown for any of the phases and voltage and current are not zero for this phase, check out following points:

- Assure that A, B and C phases coincide in voltage and current.
- Correct polarity? Reverse the current transformer placed at this phase.



4. - OPERATION MODE

When the device is powered on, the entire symbol will be on, and the meter starts to self- test. After few seconds, the meter is ready for operation and shows firmware, then automatic jump to The first screen.

Button	In Monitor Screen	In Config sub-menu	In Parameter Setup
	Screen will move to previous or next page	Move cursor up and down to select function	Move setting cursor to left
			Scroll selection number 0 ~ 9
	Call out password screen	Exit & roll back to up level menu.	
	Call out Sub-screen(*chapter 5.1 note1) or RTC screen	Confirm the values & Entry or jump to down level menu	

Notes:

1.In Setup menu, if changed the setting value, press  for exit menu, device will call out confirm screen ask "SAVE"

Then press  *exit without saving*
 press  *save and exit.*



2.In some screen the button has different operation logic, in display screen have symbol to illustrate.

5. SCREEN DISPLAY

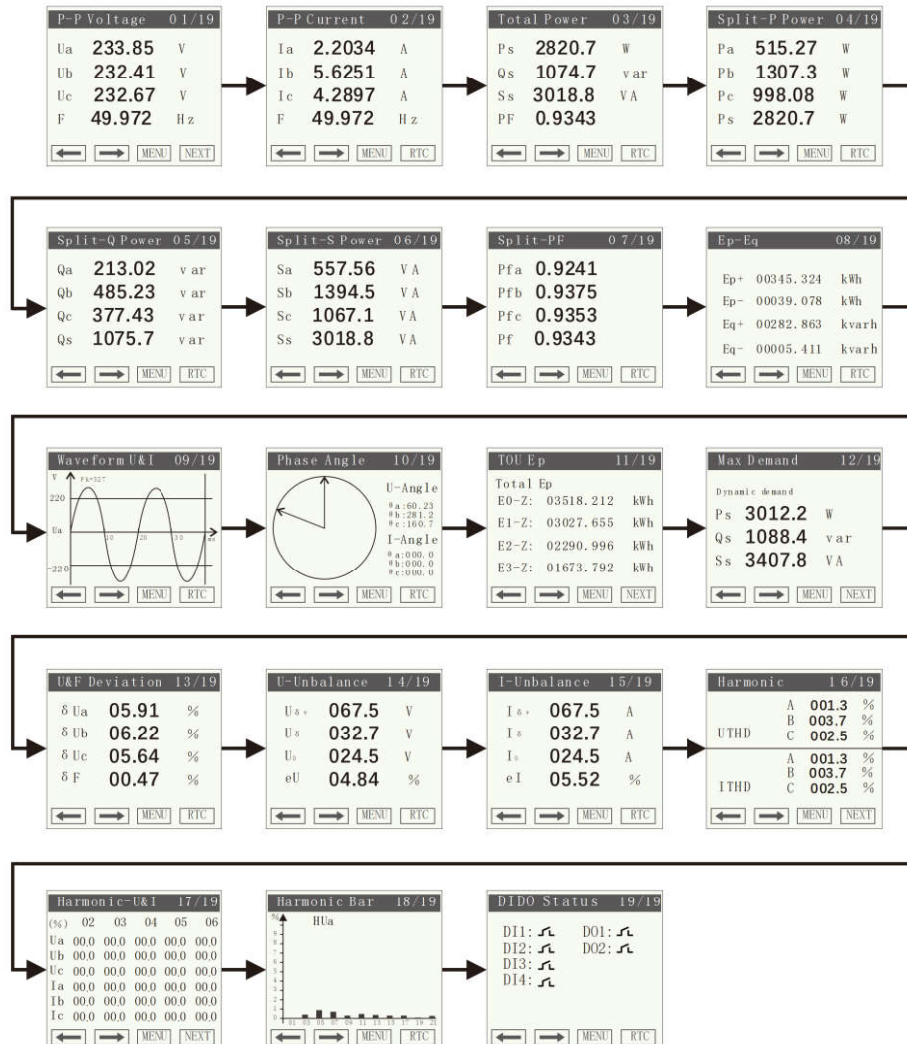
5.1.-Overall of the Screen pages



Notes:

1. Energy data is displayed in 8-digit decimal format by default. As counter increased, decimal point position will move right, data increased by 10 times, unit display changing from KWh to MWh.
2. In screen page01, 11, 12, 16, 17 can press button  to enter sub-screen to read more info of this screen page.
3. Other screen press button  to check Real time clock.
4. If do not choose DI/DO function module, there only 18 pages' screen.

6. - SETUP PROCEDURE

The SETUP procedure of the BJ-194Q is performed by means of several SETUP options. There has a password to protect unexpectedly enter the Setup menu. Once into the Setup menu, use the keyboard to select different options and enter required variables:

6.1.- Main Configuration Menu

Press **SET** button in any of the monitor screen page can call out the password screen.

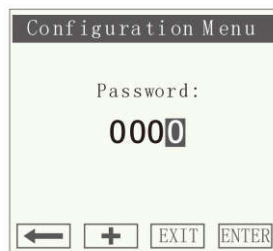

Enter the default password **0001** can enter the configuration menu.

Note:

If changed the password, please keep the password in safety, or only need to ready password from RS485 port.

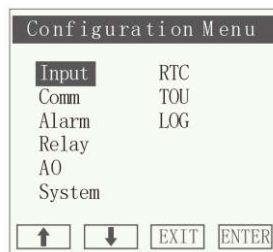

There are 9 sub-menus for meter configuration:

Input	Basic settings of signal access	AO	Analog output port setting
Comm	Communication port setting	System	System settings & Clear memory logging info
Alarm	Alarm trig threshold setting	RTC	Real-time clock setting
Relay	Digital relay output port setting	TOU	Time of use record setting
LOG	Reading logging data		

Note: "LOG" menu is for reading logging data that record in the meter memory.

6.2.- Input Setting

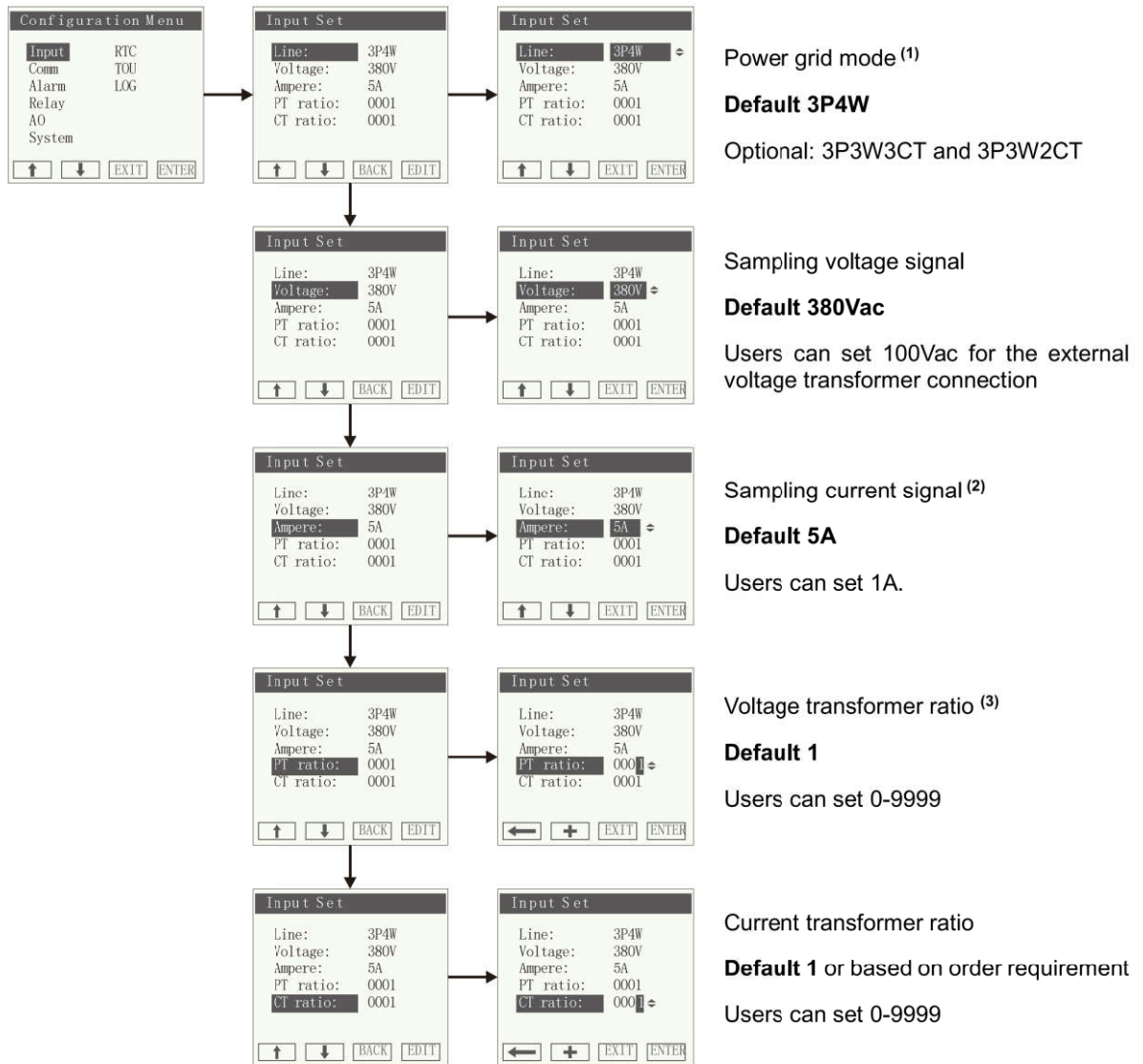

Notes:

- (1) In 3P3W mode, shorted Ub and Un external are needed.
- (2) If users need other range of CT connection, please contact our sales team before order.
- (3) In 380V range please set PT ratio to 1; in 100V range users can set PT ratio to expand measurement range.

6.3.- Communication Port Setting



Note: 194Q optional dual communication port; Comm-2 can be used for external HMI or other special operation, default only Comm-1 is valid.

6.4.- Alarm Setting

BJ-194Q provides 5* **[Virtual Alarm]** for remote communication, defined in “Alarm-1”, “Alarm-2” ... “Alarm-5”. When the meter detects that the parameter is up to or down to pre-setting limit, it will be shown in register and SOE. If the meter is equipped with physical DO port, the relay can be triggered by the linkage configuration.

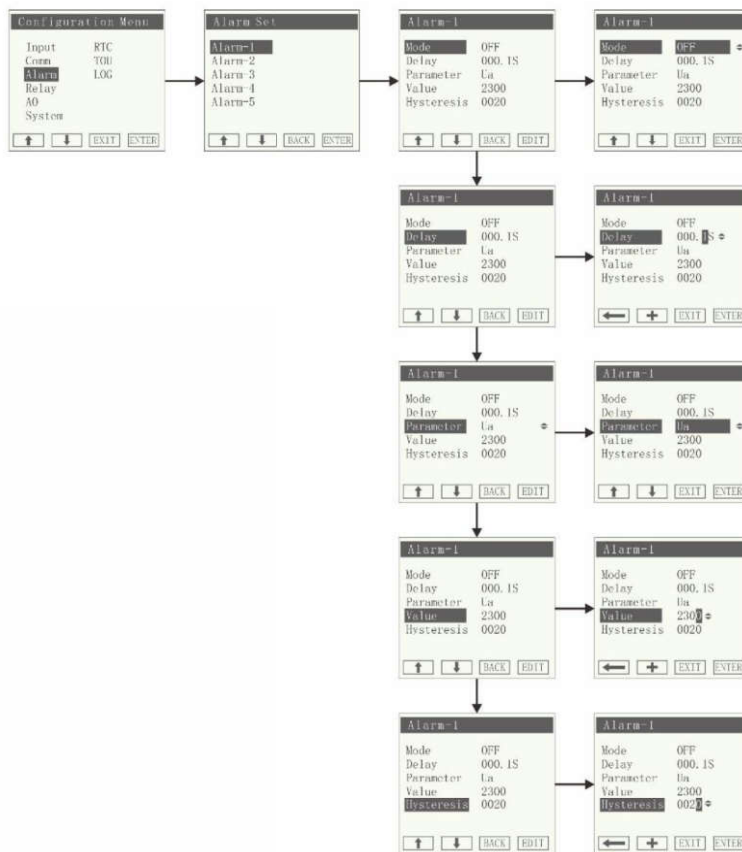

Alarm-1 operation mode

Optional: “Upper”(upper limit),
“Lower” (lower limit)

Default OFF

Operation trig delay timer

Default 0.1sec

Alarm-1 trig parameter

Default Ia

Trig parameter threshold

Default 2000

Trig status release Hysteresis

Default 0050

6.4.1.- Alarm setting description

Sub-setting	Settings value	Definition
Mode	OFF / Upper Limit / Lower Limit	Default OFF
Delay*	0.1~999.9s	After the preset parameter is over the setting value in the specified delay, Virtual Alarm will be triggered. Default 0.1s
Parameter	$U_a / U_b / U_c / U_{ab} / U_{bc} / U_{ca} / U_{abc}$ $I_a / I_b / I_c / I_{abc}$ $P_a / P_b / P_c / P_s$ $Q_a / Q_b / Q_c / Q_s$ $S_a / S_b / S_c / S_s$ PF / Fr $DI_1 / DI_2 / DI_3 / DI_4 / DI_5 / DI_6$	Parameter be triggered Notes: U_{abc}, I_{abc} mean any value in phase P_s, Q_s, S_s mean total value in three phase Not all values above are displayed on the setting screen. It depends on sub-mode of BJ-194Q
Value	0~9999	Trig threshold, value related to secondary side, units: Voltage - 0.1V Current - 0.001A Active power - 0.1W Reactive power - 0.1VAR Power factor - 0.001 Frequency- 0.01HZ Default is 5500
Hysteresis*	0~9999	When the measurement parameter falls back lower / over this exceed value, the alarm will be released. Default is 0050

6.4.2.- Delay & Hysteresis operation logic

An example in upper limit alarm of A phase voltage:

U-d means detected Ua

U-set mean Alarm value of A phase

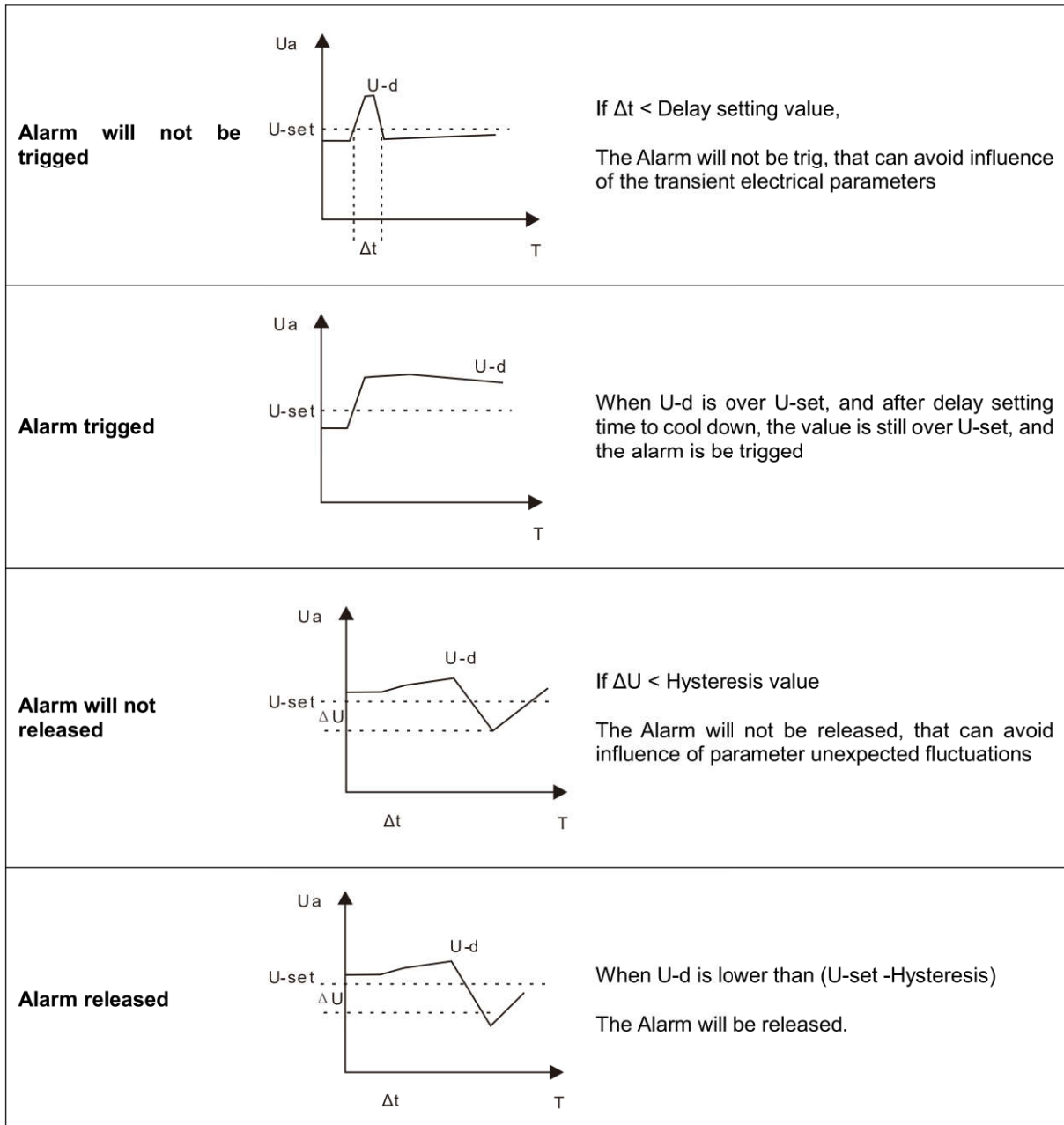

6.5.- Relay setting (Optional DO port)

BJ-194Q optional physical DO port, if do not choose this external port, this chapter are invalid. When the device has more than one DO port, users can set the DO-2, DO-3...as same step.

The physical DO relay standard is 5A 250VAC / 5A 30VDC



Note: If do not select DO output module, this menu cannot be accessed.

6.5.1.- Relay setting description

Sub-setting	Settings value	Definition
Mode	Remote* / [Alarm-X] [NC] / [NO]	Remote - DO is acted by RS-485 control command [Alarm-X] - DO acts when Alarm-X is triggered [NC] – DO is always closed, cannot control [NO] – DO is always opened, cannot control Default Remote
Time	0.0~999.9s	000.0 - Level type signal, contact coil will be closed when it is triggered 000.1~999.9 - Pulse type signal, value for width. Contact coil will be closed in the pulse width time, then release Note: In [Alarm-X] the value setting is valid Default 0.1s

6.5.2.- Remote mode operation

In “Remote” mode, users can use the function code 05 to trig single relay, and the device RS-485 port follow MODBUS-RTU protocol, command as following:

Host inquiry:

Address	Code	No.1 Relay register	Relay value (FF00:close; 0000: open)	CRC
01	05	00 01	FF 00	DD FA

Relay value: FF00 means close, while 0000 means open.

Slave response:

Address	Code	No.1 Relay register	Relay value (FF00:close; 0000: open)	CRC
01	05	00 01	FF 00	DD FA

6.6.- Analog Output Setting (Optional AO port)

BJ-194Q optional max 3* Analog output port, which can generate analog signal to downstream equipment.

Basic specification

AO output type	Output 4 ~ 20mA / 0~20mA or 1 ~ 5V
Accuracy class	0.5S
Overload	120% effective output, the maximum current of 24mA, voltage 15V
Load	$R_{max} = 420\Omega$
Isolation	1kV to other terminal (Between AO-AO port non-isolation)



Note: If do not select AO output module, this menu cannot be accessed.

6.6.1.- Analog output setting

Sub-setting	Settings value	Definition
Mode	4-20 / 12-20 / 0-20 0-5 / 0-10	Output current signal range, unit mA Default 4-20
Parameter	$U_a / U_b / U_c / U_{ab} / U_{bc} / U_{ac}$ $I_a / I_b / I_c / PF / Fr$ $P_a / P_b / P_c / P_s$ $Q_a / Q_b / Q_c / Q_s$ $S_a / S_b / S_c / S_s$	Parameter that can be set Default: Ua
LDIS	0~9999	Zero scale value for transmission output, units: Voltage - 0.1V Current - 0.001A Active power - 0.1W Reactive power - 0.1VAR Power factor - 0.001 Frequency- 0.01HZ Default is 0000
HDIS	0~9999	Full scale value for transmission output, units are same with LDIS Default is 5000

6.7.- System Setting



Notes:

- (1) The data log is optional function, and data is not displayed on the screen, only read by MODBUS polling command, details please refer [chapter 7.1](#).
- (2) Customers can write commands through RS485 or through the screen to clear the energy data to 0. Once the secondary side value of the internal memory reaches to $2^{32}(4294,967,296)$, counter automatically reset to 0. if no such function, this sub-menu is invalid.

6.8.- RTC setting (Real time clock)

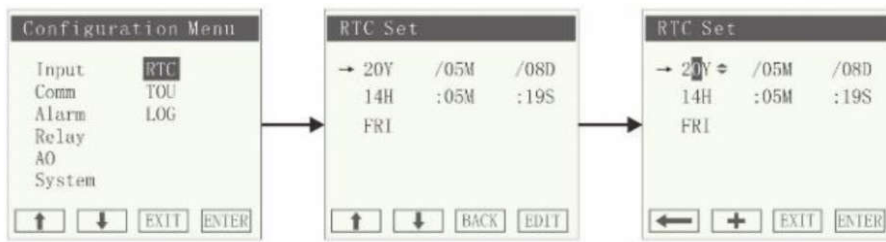

Users can set:
Year / Month /
Date/Hour/Minute/
Second
Day

Note:

194Q inside with 1* CR2032 battery for keeping RTC chip always run, without AUX power the battery life can support 5~6 years working. When AUX power is accessed, the meter will automatically transfer to use aux power line, and battery power loops will be disconnected.

Before shipping Blue Jay will set RTC to local time zone, if need other time zone presetting, please contact our sales team or reset the RTC in meter setup.

6.9.- TOU Setting (Time of Use / Multi tariff record)

BJ-194Q provides last 3 months of TOU energy record. The TOU function separate one day into 12 segments billing interval, using T1-T4 tariff (or marked “Sharp” “Peak” “Flat” “Valley”) to indicate energy consumption in different time segment and record in memory. There are 4 different TOU billing mode which can be selected for different months in one year.

Users can get monthly energy data from panel display screen or RS485 (RS485 data refer to **Communication protocol**), and calculate their energy cost in different tariff period.

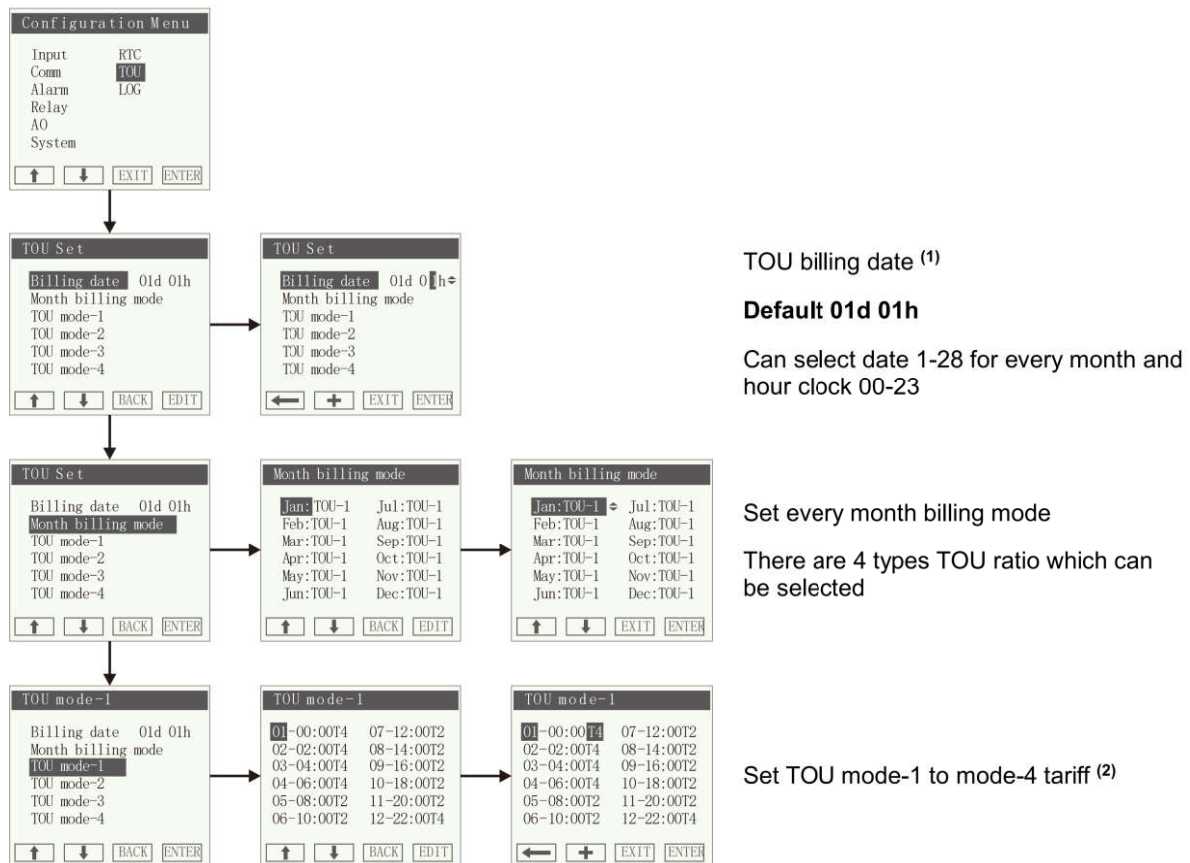

Notes:

- (1) Meter default automatic billing time meter reading time at 0:00 on the 1st of each month. Electrical energy of this month will be freeze to last month value, and the electrical energy of last month will be frozen to the month before last month. Electrical data of this month will clear and re-start record.
 - If re-set billing time miss the last billing time, the meter will immediately record billing;
 - If power off during the billing time, the meter will immediately record billing after power recover.
- (2) Billing period is designed for automatic closed loop, when Segment-X time-point equal segment-1 time-point, the remained segment setting will be ignoring by meter.

6.10.- Other ports

6.10.1.- Pulse output port

BJ-194Q provides 2* pulse output for the total active energy & total reactive energy.

The host / PLC / DI module can cumulative the data of both the active and reactive power energy sent by the pulse from opt coupler relay.

1). Electrical specification: voltage $VCC \leq 48V$, $I_z \leq 50mA$.

2). Pulse: 5000 imp / kWh, pulse up to 80ms.

This means: When the device detects 1 kWh, the port will generate 5000 pulse.

Note:

1 kWh energy is for secondary side energy data, if there are PT and CT accessed; primary side energy data is "1 kWh \times PT ratio \times CT ratio".

Voltage (V)	Current (A)	Pulse constant (imp / kWh)
380 or 220	5	5000
	1	20000
100	5	20000
	1	80000

Example: In measure time "T", the received total pulse is "N",
 Primary side input of voltage is 10kV
 Primary side input of current is 400A.
 Secondary side measurement range is 100V and 5A.

In the time "T", energy accumulated is: $N / 20000 \times 100 \times 80$

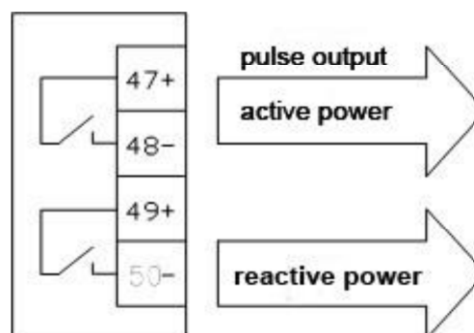

6.10.2.- Digital input port (Optional DI port)



BJ-194Q optional max 6*DI port, uses dry contact resistance switching (passive node), with +15V meter internal power supply, for detecting variety of outside coil status.

Display the coil status in monitor screen and record in register(SOE). It also can work with remote control / alarm relay for device automatic control.

Note:

The DI port operation will record in register; and can check the event record in System screen, details please refer to [chapter 7](#).

7. - Data log function

194Q provides data logging function, including DI/DO port SOE, Alarm SOE, Waveform capture. Users can check log record info in configuration menu. **LOG** sub-menu. The real-time data logger is optional function, only ready from MODBUS-RTU polling command, please refer to chapter 7.1

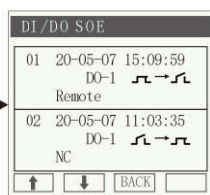

DI/DO acts SOE record ⁽¹⁾

There are 20 lists of SOE for DI/DO trig/release event

Sequence from the latest event to oldest event

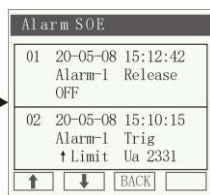

Alarm trig SOE record ⁽²⁾

There are 80 lists of SOE for alarm trig/release event

Sequence from the latest event to oldest event

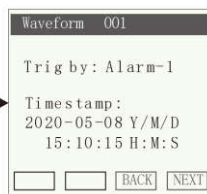
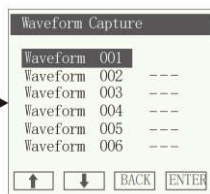

Waveform capture record ⁽³⁾

There are 100 lists of waveform capture record

Each waveform have captured timestamp record for data trace

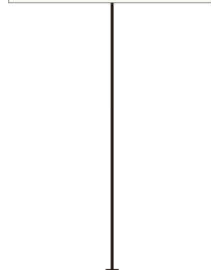

Waveform curve screen ⁽⁴⁾

One captured waveform includes three phase voltage and current. Each curve has 1000 sampling point.

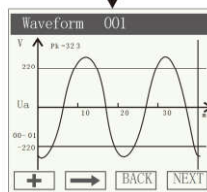

Show data log function memory capacity [\(chapter 7.1\)](#)

Notes:

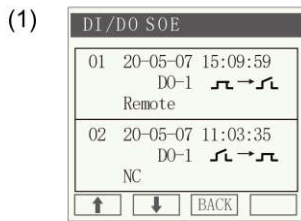

Each SOE includes:
 Timestamp
 Trig port number, trig event
 Trig mode

Demo of the event 01:
 Event time 2020-5-07, 15:09:59
 Triggered by DO-1 port, port status from closed to open
 Trig in Remote control mode

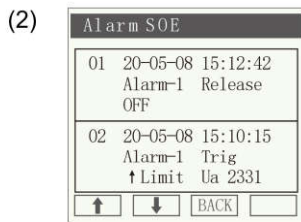

Each SOE includes:
 Timestamp
 Virtual alarm channel, trig event
 Trig operation and trip threshold

Demo of the event 02:
 Event time 2020-5-08, 15:10:15
 Alarm-1 trig
 Trig by over upper limit threshold 233.1V

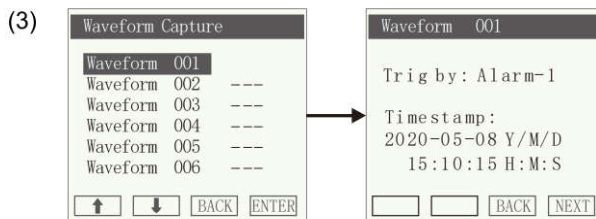

If the waveform record is empty, the screen will show "----"
 Press can turn to details page. There are timestamp show basic info.

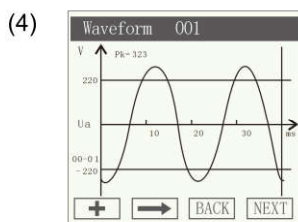

Press can switch measurement range from 100-600V or 1-7A
 Press can move to next wave (in 50Hz system there are 50 waveforms)
 Press can switch to show Ua / Ub / Uc / Ia / Ib / Ic waveform

Capture operation triggered by Alarm setting logic, the captured waveform described 1sec data when event trig time point. Waveform graphics will be displayed on the screen that can help engineer do event tracing.

Note:
 When using this function, we recommend to set the "Delay" of [Alarm-X] to 0, please refer to chapter "Alarm setting"

7.1.- Date Logger (Optional)



BJ-194Q optional equipped 128M large-capacity memory for storing electrical parameter. Logging secondary side voltage, current, active, reactive power, power factor, frequency value. Total record 233,600* logging data.

*In 1min log interval can record 160days data.

Logging data only can be read through the COMM port, using MODBUS protocol to polling. Each data package is up to 22 words, and one polling can read max 5 Record point data

Polling operation:

Step1-Use function code (0x10) to write [No.X] of data package to Reg [0x2710], requiring the device to prepare 5 newer data packets.

Step2-Use MODBUS polling command to read the logging info in Reg[0x2710-0x277d] to get 5 lists record.

Note: The latest logging data is defined as No.1 log group

Example:

Slave address 01, read data package [No.X] = No.60 (No.56~No.60)

Step1- Send command: 01 10 27 10 00 02 04 00 00 00 3C 41 02

Slave response: 01 10 27 10 00 02 4A B9

Step2- Send command: 01 03 27 10 00 6E CF 57

Slave response: 01 03 DC.....

Register map of Log record

Register	Data	Byte mode		Instruction
0x2710	Ua	int	1	Phase to Line Voltage, Unit: 0.1V
0x2711	Ub	int	1	
0x2712	Uc	int	1	
0x2713	Ia	int	1	Three phase Current, Unit: 0.001A
0x2714	Ib	int	1	
0x2715	Ic	int	1	
0x2716	Pa	int	1	Individual phase active power, Unit: W
0x2717	Pb	int	1	
0x2718	Pc	int	1	
0x2719	$P\Sigma$	int	1	Total active power, Unit: W
0x271a	Qa	int	1	Individual phase reactive power, Unit: Var
0x271b	Qb	int	1	
0x271c	Qc	int	1	
0x271d	$Q\Sigma$	int	1	Total reactive power, Unit: Var
0x271e	PFa	int	1	Individual phase power factor, 0~1.000
0x271f	PFb	int	1	
0x2720	PFc	int	1	
0x2721	$PF\Sigma$	int	1	Total apparent power, Unit: VA
0x2722	FR	int	1	Frequency, Unit:0.01Hz
0x2723-0x2725	/	Char	3	First 5 bytes are time stamp Year-Month-Date-Hour-Minutes Last 1 byte are sum check of all data in package
0x2726-0x273b	/	/	22	Logging data NO.X-3
0x273c-0x2751	/	/	22	Logging data NO.X-2
0x2752-0x2767	/	/	22	Logging data NO.X-1
0x2768-0x277d	/	/	22	Logging data NO.X

8.- COMMUNICATION INTERFACE

8.1.- Connection for RS485 BUS

The composition of the RS-485 cabling must be carried out with a meshed screen cable (minimum 3 wire), its diameter not less than 0.5mm², with a maximum distance of 1,200 m between the BJ-194... and the master unit. This Bus may connect a maximum of 32pcs BJ-194...

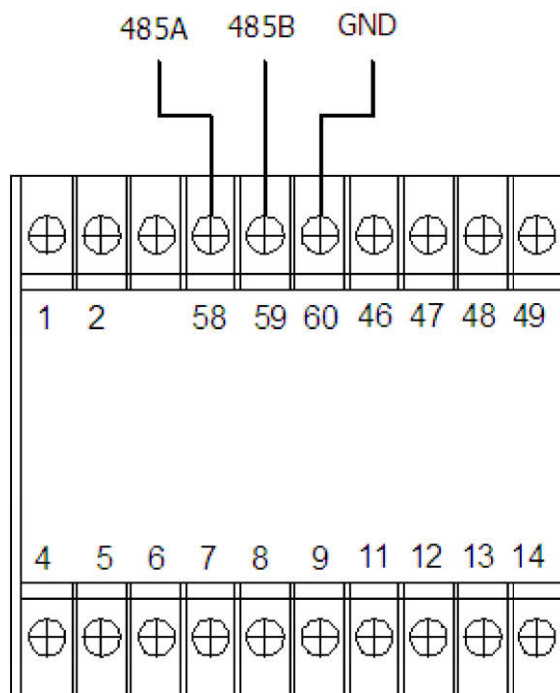

Notes:

- For communication with the master unit, users can choose RS-485 to RS-232 converter or RS485 to USB adapter to use.
- For expanding the number of devices in the communication network, a signal repeater can be used.
- Full range of BJ-194... meter RS485 PIN number is 58,59,60
- Due to product modifications or special requirements, the interface pin place may be change. For details, please refer to the product label on the rear side.

8.2.- MODBUS © Protocol

Modbus RTU Frame Format:

Address code	1 BYTE	<i>Slave device address 1-247</i>
Function code	1 BYTE	<i>Indicate the function codes like read coils / inputs</i>
Data code	4 BYTE	<i>Starting Register, high byte Starting Register, low byte Number of registers, high byte Number of registers, low byte</i>
Error Check code	2 BYTE	<i>Cyclical Redundancy Check (CRC)</i>

MODBUS FUNCTIONS:

Code	Meaning	Description
FUNCTION 01	Read Coil Status	<i>Only valid when equipped DO port</i>
FUNCTION 02	Read Input Status	<i>Only valid when equipped DI port</i>
FUNCTION 03	Reading of n Words	<i>This function permits to read all the electrical parameters of the BJ194...series.</i>
FUNCTION 05	Force Single coil	<i>Details see chart 6.4 When DO in remote control mode can work</i>
FUNCTION 06	Preset Single holding register	<i>There is an upper limit for writing, please be sure to check the upper limit of the host computer to avoid exhausting the life of the storage machine.</i>

Note: Float data follow **IEEE754**, float low bit first, high bit next. **(CD AB)**

8.3. - Register Map

8.3.1- Basic power data—Primary Side

Register	Data	Byte mode		Instruction
0x00	Ua	float	2	Phase to Line Voltage, Unit: V
0x02	Ub	float	2	
0x04	Uc	float	2	
0x06	Uab	float	2	Phase to Phase Voltage, Unit: V
0x08	Ubc	float	2	
0x0a	Uca	float	2	
0x0c	Ia	float	2	Three phase Current, Unit: A
0x0e	Ib	float	2	
0x10	Ic	float	2	
0x12	Pa	float	2	Individual phase active power, Unit: kW
0x14	Pb	float	2	
0x16	Pc	float	2	
0x18	$P\Sigma$	float	2	Total active power, Unit: kW
0x1a	Qa	float	2	Individual phase reactive power, Unit: kVar
0x1c	Qb	float	2	
0x1e	Qc	float	2	
0x20	$Q\Sigma$	float	2	Total reactive power, Unit: kVar
0x22	Sa	float	2	Individual phase apparent power, Unit: kVA
0x24	Sb	float	2	
0x26	Sc	float	2	
0x28	$S\Sigma$	float	2	Total apparent power, Unit: kVA
0x2a	PF_a	float	2	Individual three phase power factor
0x2c	PF_b	float	2	
0x2e	PF_c	float	2	
0x30	cosQ	float	2	Total power factor, 0~1.000
0x32	FR	float	2	Frequency, Unit:0.01Hz
0x34	Ep+	float	2	Positive active energy, Unit: kWh
0x36	Ep-	float	2	Negative active energy, Unit: kWh
0x38	Eq+	float	2	Inductive reactive power, Unit: kVarh
0x3a	Eq-	float	2	Capacitive reactive power

8.3.2 - Basic power data—Secondary Side

Register	Data	Byte mode		Instruction
0x100	Ua	int	1	Phase to Line Voltage, Unit: 0.1V
0x101	Ub	int	1	
0x102	Uc	int	1	
0x103	Uab	int	1	Phase to Phase Voltage, Unit: 0.1V
0x104	Ubc	int	1	
0x105	Uca	int	1	
0x106	Ia	int	1	Three phase Current, Unit: 0.001A
0x107	Ib	int	1	
0x108	Ic	int	1	
0x109	Pa	int	1	Individual phase active power, Unit: W
0x10a	Pb	int	1	
0x10b	Pc	int	1	
0x10c	P_{Σ}	int	1	Total active power, Unit: W
0x10d	Qa	int	1	Individual phase reactive power, Unit: Var
0x10e	Qb	int	1	
0x10f	Qc	int	1	
0x110	Q_{Σ}	int	1	Total reactive power, Unit: Var
0x111	Sa	int	1	Individual phase apparent power, Unit: VA
0x112	Sb	int	1	
0x113	Sc	int	1	
0x114	S_{Σ}	int	1	Total apparent power, Unit: VA
0x115	PFa	int	1	Individual power factor, 0~1.000
0x116	PFb	int	1	
0x117	PFc	int	1	
0x118	cosQ	int	1	Total power factor, 0~1.000
0x119	FR	int	1	Frequency, Unit:0.01Hz
0x11a	Ep+	int	2	Positive active energy, Unit: Wh
0x11c	Ep-	int	2	Negative active energy, Unit: Wh
0x11e	Eq+	int	2	Inductive reactive power, Unit:Varh
0x120	Eq-	int	2	Capacitive reactive power
0x122	Ang_Ua	int	1	Phase A voltage angle, unit 0.1 degree
0x123	Ang_Ub	int	1	Phase B voltage angle, unit 0.1 degree
0x124	Ang_Uc	int	1	Phase C voltage angle, unit 0.1 degree
0x125	Ang_Ia	int	1	Phase A current angle, unit 0.1 degree
0x126	Ang_Ib	int	1	Phase B current angle, unit 0.1 degree
0x127	Ang_Ic	int	1	Phase C current angle, unit 0.1 degree

8.3.3- Meter status data

Register	Data	Byte mode		Instruction
0x200	DO	int	1	Digital output: Bit 0~1 show channel 1 and channel 2 status 0 for open, 1 for closed
0x201	DI	int	1	Digital input: Bit 0~3 show channel 1 to channel 4 status 0 for open, 1 for closed
0x20A	TOU.year	int	1	Internal RTC real time clock: Year - Month - Day - Time - Minutes - Second-Day
0x20B	TOU.month	int	1	
0x20C	TOU.date	int	1	
0x20D	TOU.hour	int	1	
0x20E	TOU.minute	int	1	
0x20F	TOU.second	int	1	
0x210	TOU.day	int	1	

8.3.4- Advanced electrical parameter

Register	Data	Byte mode		Instruction
0x300	Pde	float	2	Present active power demand, Unit: W
0x302	Qde	float	2	Present reactive power demand, Unit: var
0x304	Sde	float	2	Present apparent power demand, Unit: VA
0x306	Pd_M1	float	2	Active power demand in present month
0x308	Qd_M1	float	2	Reactive power demand in present month
0x30a	Sd_M1	float	2	Apparent power demand in present month
0x30c	Pd_M2	float	2	Active power demand in last month
0x30e	Qd_M2	float	2	Reactive power demand in last month
0x310	Sd_M2	float	2	Apparent power demand in last month
0x312	Pd_M3	float	2	Active power demand in month before last month
0x314	Qd_M3	float	2	Reactive power demand in month before last month
0x316	Sd_M3	float	2	Apparent power demand in month before last month
0x318-0x31F	/	float	2	Reversed
0x320	$V_{\delta+}$	float	2	Positive sequence voltage in primary side
0x322	$V_{\delta-}$	float	2	Negative sequence voltage in primary side
0x324	V_0	float	2	Zero sequence voltage in primary side
0x326	$I_{\delta+}$	float	2	Positive sequence current in primary side
0x328	$I_{\delta-}$	float	2	Negative sequence current in primary side
0x32A	I_0	float	2	Zero sequence current in primary side

0x32C	eU	float	2	Voltage unbalance, $eU = (V_{\delta-} / V_{\delta+})\%$
0x32E	eI	float	2	Current unbalance, $eI = (I_{\delta-} / I_{\delta+})\%$
0x330	Va_d	float	2	A phase voltage deviation
0x332	Vb_d	float	2	B phase voltage deviation
0x334	Vc_d	float	2	C phase voltage deviation
0x336	F_d	float	2	Frequency deviation
0x338	Pst-Ua	float	2	Three phase Short Term Flicker Perceptibility (Pst) in past 10min Refer IEC61000-4-15
0x33A	Pst-Ub	float	2	
0x33C	Pst-Uc	float	2	
0x33E	Plt-Ua	float	2	Three phase Long Term Flicker Perceptibility (Plt) in past 120min Refer IEC61000-4-15
0x340	Plt-Ub	float	2	
0x342	Plt-Uc	float	2	
0x344	Pst-Ua_Pk	float	2	Pst peak value of flicker in A phase
0x346	Pst-Ub_Pk	float	2	Pst peak value of flicker in B phase
0x348	Pst-Uc_Pk	float	2	Pst peak value of flicker in C phase
0x34A	/	int	1	Pst record time stamp - Year
0x34B	/	int	1	Pst record time stamp - Month
0x34C	/	int	1	Pst record time stamp - Date
0x34D	/	int	1	Pst record time stamp - Hour
0x34E	/	int	1	Pst record time stamp - Minute
0x34F	/	int	1	Pst record time stamp - Second
0x350	V _{drop_A}	float	2	Three phase latest Voltage drop, unit V Default rated value 220V, lower than 90% of Rated and last 0.5 wave will trig
0x352	V _{drop_B}	float	2	
0x354	V _{drop_C}	float	2	Duration of the V _{drop} during time, unit ms
0x356	V _{drop_Ta}	float	2	
0x358	V _{drop_Tb}	float	2	
0x35A	V _{drop_Tc}	float	2	V _{drop_A} recover timestamp
0x35C	/	int	1	
0x35D	/	int	1	
0x35E	/	int	1	
0x35F	/	int	1	
0x360	/	int	1	
0x361	/	int	1	V _{drop_A} recover timestamp - Second
0x362-0x367	/	int	6	V _{drop_B} recover timestamp
0x368-0x36d	/	int	6	V _{drop_C} recover timestamp

8.3.5- Multi- tariffs ratio data

Register	Data	Byte mode		Instruction
0x400	E0_tol	long	2	The total energy
0x402	E0_T1	long	2	T1-T4 cumulative Energy record
0x404	E0_T2	long	2	
0x406	E0_T3	long	2	
0x408	E0_T4	long	2	
0x40a	E1_tol	long	2	Total energy of this month
0x40c	E1_T1	long	2	T1-T4 Energy record of present month
0x40e	E1_T2	long	2	
0x410	E1_T3	long	2	
0x412	E1_T4	long	2	
0x414	E2_tol	long	2	Total energy of last month
0x416	E2_T1	long	2	T1-T4 Energy record of last month
0x418	E2_T2	long	2	
0x41a	E2_T3	long	2	
0x41c	E2_T4	long	2	
0x41e	E3_tol	long	2	Total energy of the month before last month
0x420	E3_T1	long	2	T1-T4 Energy record of the month before last month
0x422	E3_T2	long	2	
0x424	E3_T3	long	2	
0x426	E3_T4	long	2	

8.3.6- THD and individual harmonic (Max 62 times)

Register	Data	Byte mode		Instruction
0x500	THDUa	int	1	A-phase Voltage THD
0x501	THDUb	int	1	B-phase Voltage THD
0x502	THDUc	int	1	C-phase Voltage THD
0x503	THDia	int	1	A-phase Current THD
0x504	THDib	int	1	B-phase Current THD
0x505	THDic	int	1	C-phase Current THD
0x508-0x545	HUa	int	62	Three phase voltage individual harmonic 2 th to 63 th
0x548-0x585	HUb	int	62	
0x588-0x5c5	HUc	int	62	
0x5c8-0x605	HIa	int	62	Three phase current individual harmonic 2 th to 63 th
0x608-0x645	HIb	int	62	
0x648-0x685	HIc	int	62	
0x688	TOHDUa	int	1	Three phase voltage total odd harmonic distortion, unit 0.1%
0x689	TOHDUb	int	1	
0x68a	TOHDUc	int	1	
0x68b	TEHDUa	int	1	Three phase voltage total even harmonic distortion, unit 0.1%
0x68c	TEHDUb	int	1	
0x68d	TEHDUc	int	1	
0x68e	THFFUa	int	1	
0x68f	THFFUb	int	1	Three phase voltage telephone harmonic form factor, unit 0.1%
0x690	THFFUc	int	1	
0x691	CFUa	int	1	
0x692	CFUb	int	1	Three phase voltage crest factor, unit 0.001
0x693	CFUc	int	1	
0x694	TOHDIa	int	1	
0x695	TOHDIb	int	1	
0x696	TOHDIc	int	1	
0x697	TEHDIa	int	1	Three phase current total even harmonic distortion, unit 0.1%
0x698	TEHDIb	int	1	
0x699	TEHDIc	int	1	
0x69a	KFIa	int	1	Three phase current K factor, unit 0.01
0x69b	KFIb	int	1	
0x69c	KFIc	int	1	

8.3.7- SOE record (20lists record for I/O port trig, 80 lists record for Alarm-X trig)

Register	Data	Byte mode		Instruction
0x700-0x763	I/O Event 1~20	int	5	Byte 0: Fault channel Byte 1: Fault event Byte 2,3: Fault value Byte 4: Fault time: Year Byte 5: Fault time: Month Byte 6: Fault Time: Day Byte 7: Fault time: Time Byte 8: Fault time: Minute Byte 9: Fault time: Seconds
0x764-0x8F3	Alarm record 1~80	int	5	

Byte 0	Byte 1
1:DI1 Closed 2:DI2 Closed 3:DI3 Closed 4:DI4 Closed 21:DI1 Opened 22:DI2 Opened 23:DI3 Opened 24:DI4 Opened 51: Alarm_1 triggered 52: Alarm_2 triggered 53: Alarm_3 triggered 54: Alarm_4 triggered 55: Alarm_5 triggered 61: Alarm_1 released 62: Alarm_2 released 63: Alarm_3 released 64: Alarm_4 released 65: Alarm_5 released 101:DO1 Closed 102:DO2 Closed 121:DO1 Opened 122:DO2 Opened	0: Remote control 1: DZ Alarm_1 2: DZ Alarm_2 3: DZ Alarm_3 4: DZ Alarm_4 5: DZ Alarm_5 6: Manually close DO 7: Manually open DO 100: Manually turn off DZ when triggered 101:UA upper alarm 102:UB upper alarm 103:UC upper alarm 104:UAB upper alarm 105:UBC upper alarm 106:UCA upper alarm 107:UA/UB/UC upper alarm 108:IA upper alarm 109:IB upper alarm 110:IC upper alarm 111:IA/IB/IC3 upper alarm 112:PA upper alarm 113:PB upper alarm 114:PC upper alarm 115:total active power upper alarm 116:QA upper alarm 117:QB upper alarm 118:QC upper alarm 119:total reactive power upper alarm 120:SA upper alarm 121:SB upper alarm 122:SC upper alarm 123:total apparent power upper alarm 124:total power factor upper alarm 125:frequency upper alarm 126:DI1 close alarm 127:DI2 close alarm 128:DI3 close alarm 129:DI4 close alarm 130:DI5 close alarm 131:DI6 close alarm 132:UA lower alarm 133:UB lower alarm 134:UC lower alarm 135:UAB lower alarm 136:UBC lower alarm 137:UCA lower alarm 138:UA/UB/UC lower alarm 139:IA lower alarm 140:IB lower alarm 141:IC lower alarm 142:IA/IB/IC3 lower alarm 143:PA lower alarm 144:PB lower alarm 145:PC lower alarm 146:total active power lower alarm 147:QA lower alarm 148:QB lower alarm 149:QC lower alarm 150:total reactive power lower alarm 151:SA lower alarm 152:SB lower alarm 153:SC lower alarm 154:total apparent power lower alarm 155:total power factor lower alarm 156:frequency lower alarm 157:DI1 open alarm 158:DI2 open alarm 159:DI3 open alarm 160:DI4 open alarm 161:DI5 open alarm 162:DI6 open alarm

8.3.8 - Write operation function definition: Preset Single holding register

Register	Data	Byte mode		Instruction
0x900	Line	int	1	Wiring method: 0: 3-phase 4-wire 1: 3-phase 3-wire 2CT 2: 3-phase 3-wire 3CT
0x901	U.SCL	int	1	Voltage range 0:100V 1:380V
0x902	I.SCL	int	1	Current range 0:1A 1:5A
0x903	PT	int	1	Voltage ratio
0x904	CT	int	1	Current ratio

Notes:

1. Not all data above can be read by RS485
2. Whether the data can be read out or not depends on your multi-function meter model, please refer to the corresponding product manual before build your software.
3. Some software have different definitions of the start bit of register address, there will be offset, please add 1 for the right address. To get more info, please contact technical support tech@cqbluejay.com

8.4.- Example

Host inquiry slave device

Addr.	Func.	Data Address (high)	Data Address (low)	Data Number (high)	Data number (low)	CRC16 (low)	CRC16 (high)
0CH	03H	00H	00H	00H	06H	C4H	D5H

PC users are asked to upload UA, UB, UC, IA, IB, IC

Slave device answer

Addr.	Func.	Byte count	Data1 high	Data1 low	Data2 high	Data2 low	Data3 high	Data3 low
0CH	03H	0CH	03H	E8H	03H	E9H	03H	E8H
Data4 high	Data4 low	Data5 high	Data5 low	Data6 high	Data6 low	CRC16 low	CRC16 high	
13H	84H	13H	88H	13H	8AH	A6H	D6H	

Show the data:

UA=3E8H (100.0)

UB=3E9H (100.1)

UC=3E7H (99.9)

IA=1384H (4.996)

IB=1388H (5.000)

IC=138AH (5.002)

Notes:

1. Blue Jay disables the 06 function in default setting. If users want to activated the write command, please check the host device program to avoid the meaningless write operation, which may reduce the register working life.
2. When the write is unsuccessful, no return data from the slave device. In this case, please re-send write inquiry

9. - SAFETY CONSIDERATIONS



All installation specification described at the previous chapters named:
INSTALLATION AND STARTUP, INSTALLATION MODES and SPECIFICATIONS.

Please note that as the instrument is powered on, the terminals could be dangerous to touch and cover opening actions or elements removal may allow to access dangerous parts. This instrument is factory-shipped at proper operation condition.

- ◆ The device must have a professional installation and maintenance
- ◆ Any operation of the device, you must cut off the input signal and power;

10. - MAINTENANCE

The BJ194... series meter does not require any special maintenance. No adjustment, maintenance or repairing action should be done when the instrument is open or powered on. If those actions are essential, high-qualified operators must perform them.

Before any adjustment, replacement, maintenance or repairing operation is carried out, the instrument must be disconnected from any power supply sources.

When any protection failure is suspected to exist, the instrument must be immediately put out of service. The instrument's design allows a quick replacement in case of any failure.

11. - TECHNICAL SERVICE

FAQ's

- 1.- Once cabled and connected is seen to give a correct voltage and current reading, but shows negative values for active power (generation).

This is an error with the cabling for the current transformer secondary; the direction of the transformer current has to be respected as shown in the connection diagram. The current transformers have a two face primary; the current must pass from P1 to P2 giving the result in secondary (S1 and S2) of 5 amps.

The error stems from:

- a). The current transformers have been incorrectly installed. As a result, it gives the direction of the current as passing from P2 to P1; to resolve this problem, the current transformer does not have to be dismantled and installed again, but the transformer secondary (S1 and S2) just has to be inverted.
 - b). The connection of the current secondary in the current transformers have been incorrectly connected; to resolve this problem just connect the S1 transformer secondary to the S1 on the meter and the S2 on the current transformer to the S2 on the meter
- 2.- Once cabled and connected, is seen to give an incoherent Power factor and Cos Φ reading (-0.01 or similar).

This is again a current transformer and voltage phase connection error phase A, must correspond to the current transformer installed in phase A; phase B, must correspond to the current transformer installed in phase B; and phase C, must correspond to the current transformer installed in phase C.

This connection terminal is clearly shown on the area side of the device.

- 3.- The measuring voltage and is displaying the secondary voltage (for example 110 volts). Ensure that the voltage Transformer ratio has been correctly set (Please refer to voltage PT ratio setting section in chapter **SETUP PROCEDURE**).
- 4.- Device does not correctly display the current reading. It shows values varying between 0 to 5 amps of current. Ensure that the Current Transformer ratio has been correctly set; (Please refer to current CT ratio setting section in chapter **SETUP PROCEDURE**).

Calculation formula of Electrical parameter

Formula	Parameter
$U = \sqrt{\frac{1}{N} \sum_{n=0}^N u_n^2} \quad n = 0,1,2 \dots \dots N$	Voltage RMS value
$I = \sqrt{\frac{1}{N} \sum_{n=0}^N i_n^2} \quad n = 0,1,2 \dots \dots N$	Current RMS value
$P = \frac{1}{N} \sum_{n=1}^N (i_{an}u_{an} + i_{bn}u_{bn} + i_{cn}u_{cn})$	Total active power cycle average
$P_s = UI$	Single-phase apparent power cycle average
$\cos \theta = \frac{P_p}{P_s}$	Power factor
$P_q = \sqrt{P_s^2 - P_p^2}$	Reactive power (Pq is positive and the direction cannot be determined; P algorithm can be used to shift the voltage component by 90o)
$W = \int P * dt$	Electric energy

Note: In above formula, N for sampling points in one AC wave, In standard BJ-194Q, the N=128

For any inquiry about the device performance or any failure, contact to Blue Jay's technical service.

Blue Jay - After-sales service