

APM-96J

Multi-Function Power Meter

User Manual



Version: 1.10

Revision: 2024.12

Read me

When you use APM-96J multi-function meter, be sure to read this user manual carefully, and be able to fully understand the implications, the correct guidance of operations in accordance with user manual, which will help you make better use of APM-96J multi-function meter, and help to solve various problems at the scene.

1. Before the meter turn on the power supply, be sure that the power supply within the provisions of the instrument;
2. When installation, the current input terminal must be non-open, voltage input terminals must be Non-short circuit;
3. Communication terminal (RS232/RS485) is strictly prohibited to impose on high pressure;
4. Be sure the instrument wiring is consistent with the internal system settings;
5. When communicating with the PC, instrument communication parameters must be consistent with the PC.



- **Please read this user manual carefully**
- **Please save this document**

Directory

1. - SUMMARIZE	- 3 -
2. - FEATURES	- 4 -
2.1. - ELECTRICITY METERING.....	- 4 -
2.2. - TECHNICAL PARAMETERS	- 5 -
3. - INSTALLATION AND START-UP	- 7 -
3.1. - INSTALLATION.....	- 7 -
3.2. - CONNECTION TERMINAL	- 10 -
3.3. - TYPICAL WIRING (3P4W)	- 11 -
4. - SCREEN DISPLAY	- 12 -
4.1. - FULL SYMBOL IN DISPLAY SCREEN.....	- 12 -
4.2. - INTRODUCTION OF SCREEN PAGES	- 13 -
5. - OPERATION MODE	- 16 -
6. - SETUP PROCEDURE	- 17 -
6.1. - ENTER SETUP MENU.....	- 17 -
6.2. - INPUT SIGNAL SETUP.....	- 18 -
6.3. - COMMUNICATION PORT SETUP.....	- 18 -
6.4. - DIGITAL OUTPUT SETUP.....	- 19 -
6.5. - ANALOG OUTPUT SETUP.....	- 19 -
6.6. - SYSTEM SETTING.....	- 20 -
6.7. - FLOWCHART EXPLANATION.....	- 21 -
6.8. - MENU CHARACTER DESCRIPTION.....	- 22 -
7. - PULSE OUTPUT	- 23 -
8. - COMMUNICATION INTERFACE	- 24 -
8.1. - CONNECTION FOR RS485 BUS	- 24 -
8.2. - MODBUS © PROTOCOL.....	- 25 -
8.3. - REGISTER MAP.....	- 26 -
9. - SAFETY CONSIDERATIONS	- 32 -
10. - MAINTENANCE	- 32 -

1. - SUMMARIZE

APM-96J multi-function power meter has functions such as programmable measurement, display, transmission output, digital communication and power pulse output. It can complete power measurement, power metering, data display, collection and transmission.

The measurement accuracy is 0.5S level, which can be achieved On-site display and remote RS-485/MODBUS-RTU communication. Optional dimension 72*72mm, 80*80mm, 96*96mm, 42*mm.

It can measure all power parameters in power grid:

Current,	Apparent power,	Voltage and current
Voltage,	Energy (Active/Reactive),	THD%,
Frequency,	Power factor,	Harmonics factor,
Active power,	Current harmonics 2~31 times,	Voltage crest factor,
Reactive power,	Voltage harmonics 2~31 times,	Current K-factor,
Voltage /current unbalance*	Voltage/frequency deviation*	Multi- tariffs ratio.

Note :* represent optional functions.

APM-96J supports RS485 / MODBUS-RTU communication and optional Profibus-DP protocol. APM-96J offers optional expansions modules including 2-8 channel digital input (DI), 2-6 channel digital output (DO), and 1-4 channel analog output (AO).

APPLICATIONS

- Measure all power parameters;
- Monitor and control, energy measurement and electrical fire;
- Replace the three-phase power meter, three phase electricity transmitter;
- Transformers, generators, capacitors and electric motors distributed detection;
- Medium and low voltage systems;
- SCADA, EMS, DCS integrators.

2. - FEATURES

2.1. - Electricity Metering

By means of an internal microprocessor it simultaneously measures:

Parameter	Symbol	A-phase	B-phase	C-phase	Total
Phase-line voltage	V	●	●	●	/
Phase-phase voltage	V	●	●	●	/
Current	A	●	●	●	/
Frequency	Hz	●	●	●	●
Power factor	Cos Φ	●	●	●	●
Active power	W	●	●	●	●
Reactive power	Var	●	●	●	●
Apparent power	VA	●	●	●	●
Active energy	Wh	●	●	●	●
Reactive energy	Varh	●	●	●	●
Multi-tariffs energy record	Wh	/	/	/	/
Max demand (W / var / VA)	MAX	/	/	/	/
Voltage / frequency deviation	V	o	o	o	o
Voltage / current unbalance	%	o	o	o	o
THD & Harmonic (2~31 th)	THD	●	●	●	●

●: Display and communications

o: Optional functions

/: No such function

Note:

Phase-phase voltage is Uab, Ubc, Uca, voltage data determined by the different wiring.

APM-96J delivers the visualization of parameters listed above by means of LED type displays. In the main display area show 3 power parameters, with other display area show the various parameters and state of meter on each page jump. For more details of measurement parameters please refer to the subsequent for displays introduction and RS485 communication instructions.

OTHER FEATURES

- Low-size (96 x 96 mm), panel mounting meter.
- True R.M.S. measuring system.
- Instantaneous, maximum and minimum values of each measured parameter.
- Energy measurement (indication through a lighting led).
- RS-485 communication to a PC.

2.2. - Technical parameters

- Working Power

AC/DC 85-265V, (DC 48V or AC 380V customized)

45-65Hz

Consumption $\leq 4VA$

- Reference Standard

Basic electricity IEC 61557-12:2016

Active energy IEC 62053-21:2018

Reactive energy IEC 62053-24:2018

- Input

Voltage AC100V, 220V, 380V
type 96mm and 42mm support AC690V, please specify when ordering).

Current AC1A/5A (please specify when ordering)

Frequency 40~65Hz, accuracy class: $\pm 0.02Hz$

Current overload Measurement: 1.2 times Instantaneous: 2 times/10s

Voltage overload Measurement: 1.2 times Instantaneous: 2 times/10s

- Output

Digital interface RS-485, MODBUS-RTU or DLT645-2007

Pulse output 1 Channel

DI (optional) 4 DI, dry contact, $R_i < 500\Omega$ turns on, $R_i > 100k\Omega$ turns off

DO (optional) 2 DO, Relay contact capacity: 5A@250V AC; 5A@30V DC

AO (optional) Current 4~20mA, load $< 390\Omega$

Voltage 0~10V, load $> 100k\Omega$

- Load

Voltage: $< 0.1VA$ / phase (rated 220V)

Current: $< 0.4VA$ / phase (rated 5A)

- Accuracy

Parameter	Accuracy	A phase	B phase	C phase	All
Voltage	0.5s	V1	V2	V3	
Current	0.5s	A1	A2	A3	
Active Power	0.5s	W1	W2	W3	W
Reactive Power	1.0	var1	var2	var3	var
Apparent Power	0.5s	VA1	VA2	VA3	VA
Power Factor	0.5s	PF1	PF2	PF3	PF
Active Energy	0.5s				Wh
Reactive Energy	1.0				varh
Frequency	0.02				Hz

- Environment

Working temperature: -10°C ~ +55°C; RH 20% ~ 95% (Non-condensation)

Storage temperature: -30°C ~ +70°C; RH 20% ~ 95% (Non-condensation)

- Safety

2kV AC RMS 1 minute, between input / output / case / power supply

Input, output and power supply to the chassis $\geq 100\text{M}\Omega$

3. - INSTALLATION AND START-UP



The manual you hold contains information and warnings that -users should follow in order to guarantee a proper operation of all the instrument functions and keep it in safety conditions. The instrument must not be powered on and used until its definitive assembly is on the cabinet's door.

If the instrument is not used as manufacturer's specifications, the protection of the instrument will be damaged.

When any protection failure is suspected to exist (for example, it presents external visible damages), the instrument must be immediately powered off. In this case contact a qualified service representative.

3.1. - Installation

Mounting

Instrument is to be mounted on panel (cut-out $91+0.8 \times 91+0.8 \text{ mm}$). Keep all connections into the cabinet.

Please note that as the instrument be powered on, the terminals could be dangerous to touch and cover opening actions or elements removal may allow accessing dangerous parts. Therefore, the instrument must not be used until this is completely installed.

Dimension:

Unit: mm

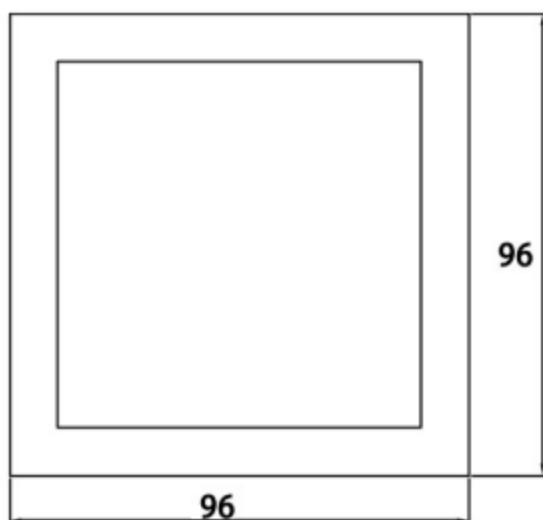

Front view

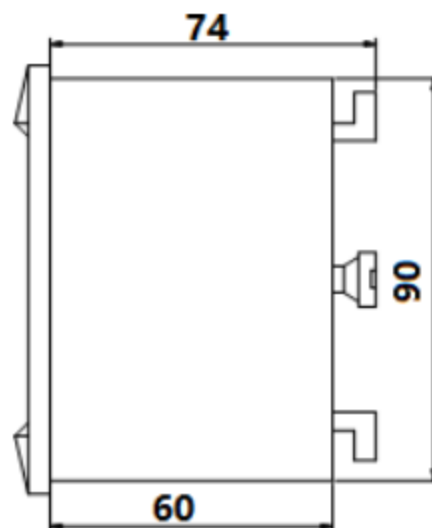

Side view

Notes:

Input signal: APM-96J using a separate acquisition calculate for each measurement channel, to ensure consistent in use, for different load forms, it's a variety of connection mode. Access wire shall be met 2.5 square mm.

A. Voltage input

Input voltage should not exceed the rated input voltage products 450V.
Otherwise, you should use external VT. Suggest 1A fuse be installed in the voltage input side.

B. Current Input

Standard input current is 5A or 1A, if greater than 5A/1A should use external CT.
When the CT is connected with other meters, make sure wiring methods be used in series.

Warning: Forbid to install a CT on the live feeder wire with open secondary leads. This can be extremely dangerous!

Before remove the current input connection, must be sure to disconnect the primary circuit or shorted secondary circuit of CT.

C. Sequence of wire

Warning: Please make sure that the input voltage and current corresponding to the same phase, sequence, and the same direction; Otherwise, the Values and symbols will be wrong! (Power and Energy)

Always observe the physical orientation of CT (P1 - P2) when installing on the feeder wire.
Always pay attention to wiring polarity and phasing when terminating the CT leads to the APM-96J.
S1 connect to Ix*, S2 connect to Ix.

The input network configuration of instrument depends on the CT number of the system:
in the condition of 2 CT, select the three-phase, three-lines two components;
in the condition of 3 CT, select the three-phase, four-lines three component mode.

Instrument connection mode, set of the instrument (programming input network NET) should be the same load wiring as measured wiring. Otherwise, the measurement instrument will lead to incorrect voltage or power.

In three-phase 3 wire mode, measurement and shows the line voltage;
In three-phase 4 wire mode, measurement and shows the phase voltage and line voltage both.

D. Auxiliary power

APM-96J with universal (AC / DC) power input, if not for a special statement, we provide the 90-240AC/DC power interface for standard products, please ensure that the auxiliary power can match with meter to prevent unexpected damage.

- A. Suggest install 1A fuse in the fire line side.
- B. For the areas with poor power quality, suggest install lightning surge suppressor and rapid burst suppressor to prevent lightning strikes.

3.2. - Connection Terminal

Upper: (Power supply and function output (15-pin))

No.	Marked	Notes
1	L	AUX input 85-265Vac/dc
2	N	
58	RS485	RS485+
59		RS485-
47	Pulse output	Pulse output+
48		Pulse output-
70 71 72 73 74	4 DI	4 channel digital input
19 20 21 22	2 DO	2 channels digital output

Upper: (Power supply and optional AO (9-pin))

No.	Marked	Notes
1	L	AUX input 85-265Vac/dc
2	N	
58	RS485	RS485+
59		RS485-
47	Pulse output	Pulse output+
48		Pulse output-
15 16 17	2 AO	2 channels Analog output

Lower: Signal (10-pin)

No.	Marked	Notes
11	Ua	Voltage A-phase input
12	Ub	Voltage B-phase input
13	Uc	Voltage C-phase input
14	Un	Neutral Voltage input
8	C-phase Current	Current C-phase - S1 input
9		Current C-phase - S2 input
6	B-phase Current	Current B-phase - S1 input
7		Current B-phase - S2 input
4	A-phase Current	Current A-phase - S1 input
5		Current A-phase - S2 input

Note:

The terminal pin definition may change depends on customer order; please refer to the label on the meter!

3.3. - Typical Wiring (3P4W)

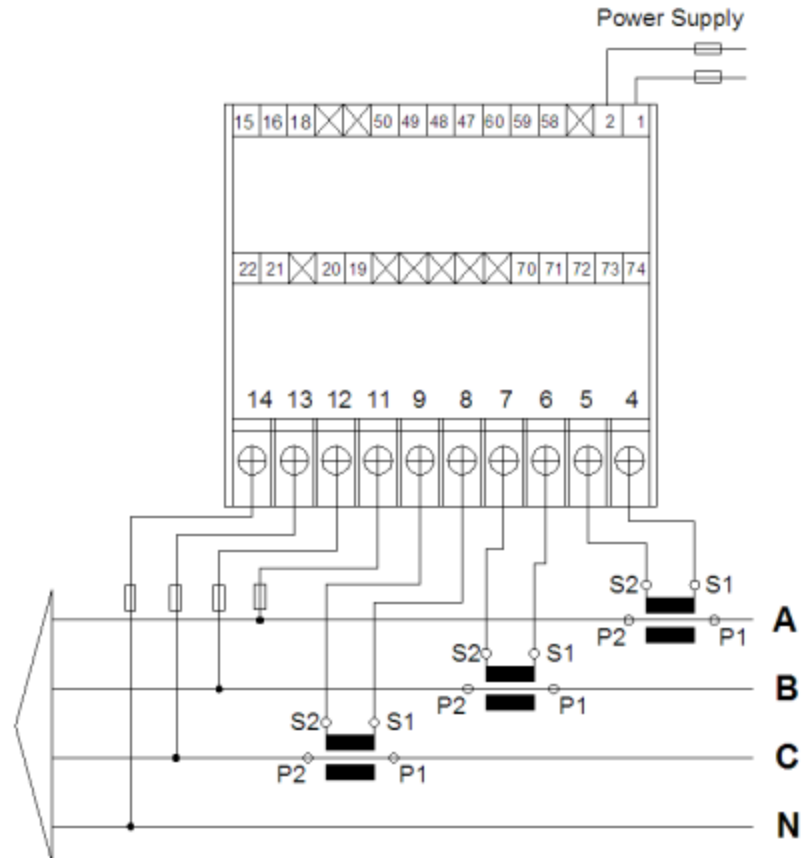

Note:

This connection drawing is for reference only; the actual connecting terminal, please refer to the label on the rear part.

WARNINGS!

If power = -0.01 is shown for any of the phases and voltage and current are not zero for this phase, check out following points:

- Assure that A, B and C phases coincide in voltage and current.
- Correct polarity? Reverse the current transformer placed at this phase.

4. - SCREEN DISPLAY

4.1. - Full Symbol in Display Screen



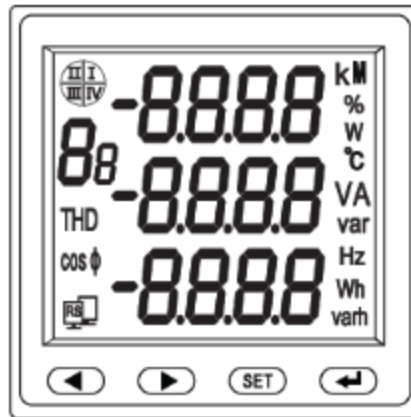



Measurement data display area can display three rows characters including: current, voltage, power, power factor, frequency, etc.

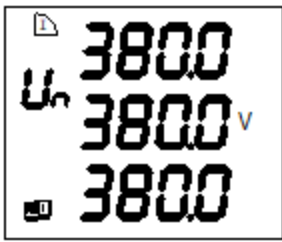
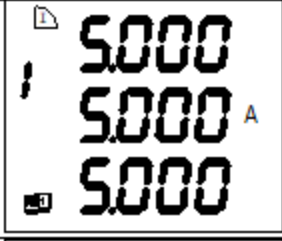
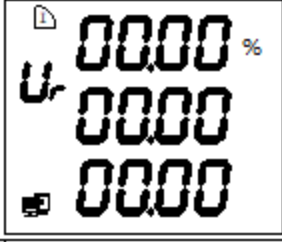
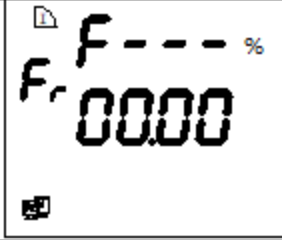
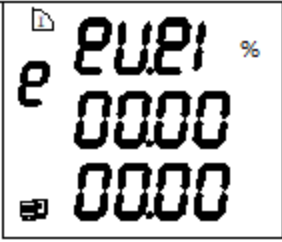
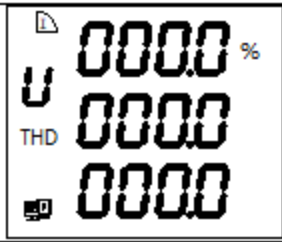

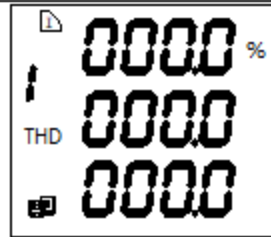
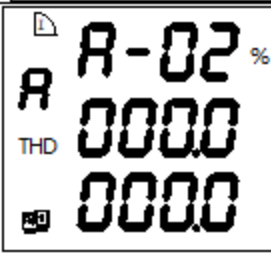
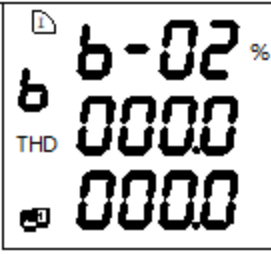
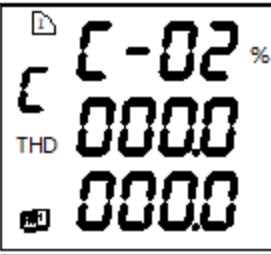

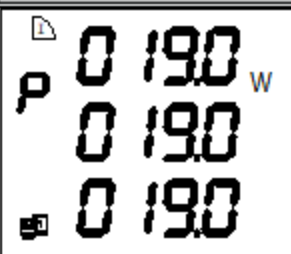

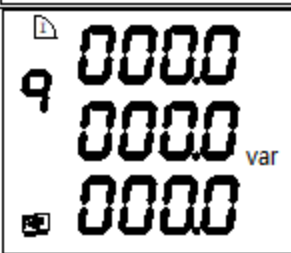

“THD”	Total harmonics
“COSφ”	Power factors
4 Quadrants	I, II, III, IV respectively represent quadrant 1.2.3.4
	A: Current
	V: Voltage
	W, KW: Active power
	Var, Kvar: Reactive power
Unit	VA, KVA, MVA: Apparent power
	Hz: Frequency
	%: Percentage
	Wh, KWh: Active power
	Varh, Kvarh: Reactive power

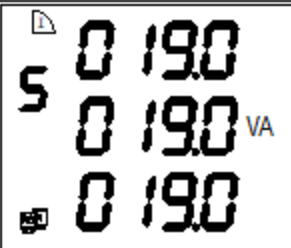
4.2. - Introduction of Screen Pages



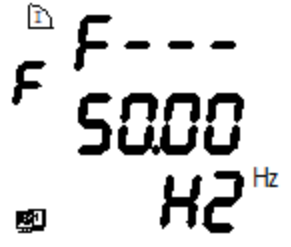

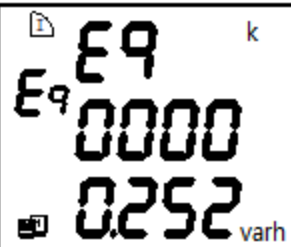
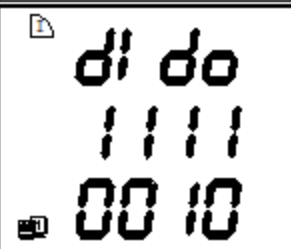
No.	Screen	Description
- 1 -		Three phase voltage: Ua, Ub, Uc "Un": phase voltage; "UL": line voltage
- 2 -		Three-phase current: Ia, Ib, Ic
- 3 -		Voltage deviation
- 4 -		Frequency deviation
- 5 -		Voltage and current imbalance
- 6 -		Voltage total harmonic distortion rate, unit is %

- 7 -		Current total harmonic distortion rate, unit is %
- 8 -		A- phase voltage and current harmonic components
- 9 -		B- phase voltage and current harmonic components
- 10 -		C- phase voltage and current harmonic components
- 11 -		P: Total active power, Q: Total reactive power, PF: Total power factor
		Press  shift displays individual phase active power (Only valid in 3P4L)
		Press  shift displays individual phase reactive power (Only valid in 3P4L)

		Press  shift displays individual phase apparent power (Only valid in 3P4L)
		Press  shift displays individual phase power factor (Only valid in 3P4L)
- 12 -		Frequency
- 13 -		Positive active energy
- 14 -		Positive reactive energy
- 15 -		DI/DO status

5. - OPERATION MODE

When the device is powered on, the entire symbol will be on, and the meter starts to self-test. After few seconds, the meter is ready for operation and shows firmware, then automatic jump to The first screen.

Button	In Monitor Screen	In Config Sub-menu	In Parameter Setup
	Screen will move to previous or next page	Move cursor up and down to select function	Move setting cursor to left
			Scroll selection number 0 ~ 9
	Call out password screen	Exit & roll back to up level menu.	
	Call out Sub-screen or Version screen	Confirm the values & Entry or jump to down level menu	

Note: In Setup menu, if change the setting value, press  for exit menu, device will call out confirm screen ask "SAVE"

Then press  exit without saving.

press  save and exit.

6. - SETUP PROCEDURE

The SETUP procedure of the APM-96J is performed by means of several SETUP options. There is a password to protect unexpectedly to enter the Setup menu. Once into the Setup menu, use the keyboard to select different options and enter required variables:

6.1. - Enter Setup Menu

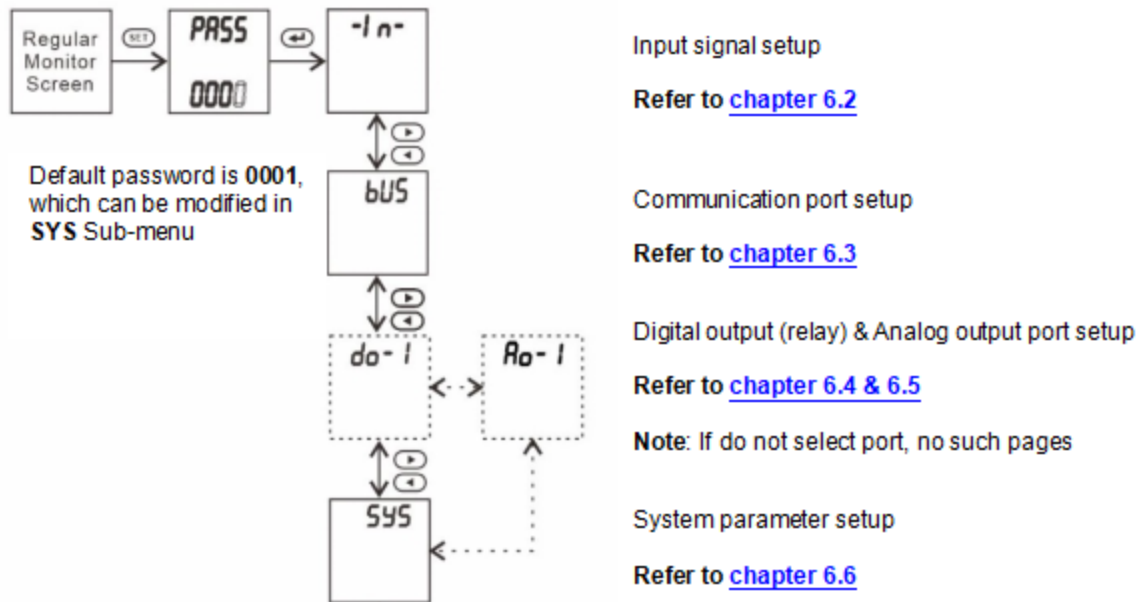

6.2. - Input Signal Setup

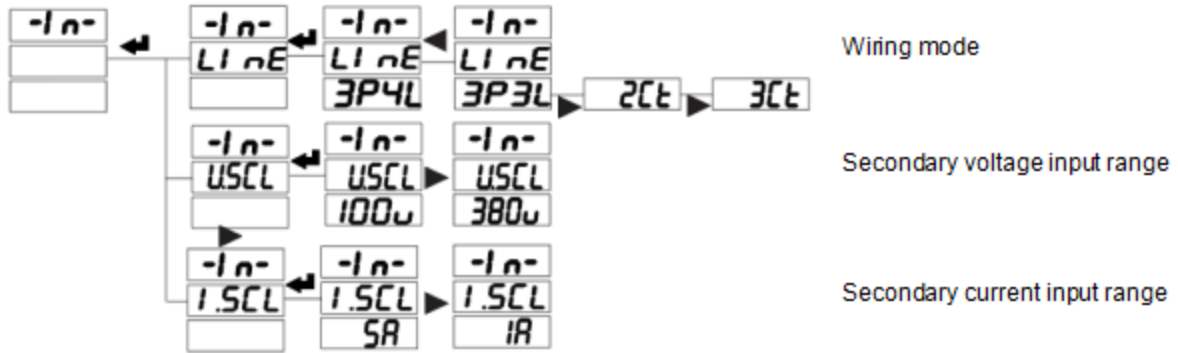

6.3. - Communication Port Setup

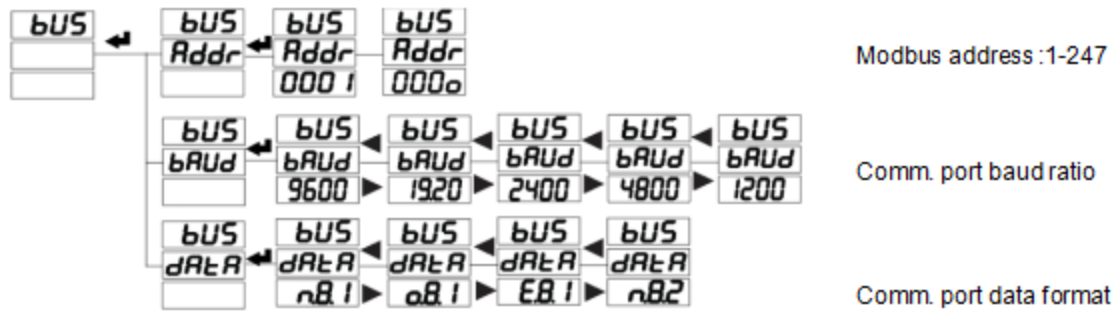

6.4. - Digital Output Setup

DO port is optional module, if do not choose this external port, in Setup menu do not have this sub-menu, and this chapter are invalid.

DO port is optional. If users do not need/ choose this external port, this sub-menu will not be displayed on the setup menu, and this chapter is invalid.

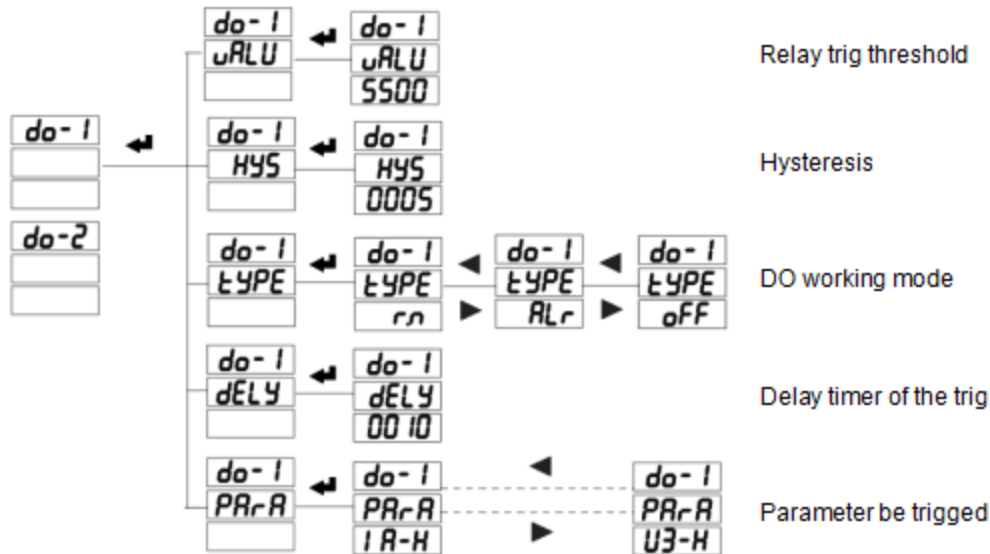

6.5. - Analog Output Setup

AO port is optional module, if do not choose this external port, in Setup menu do not have this sub-menu, and this chapter are invalid. When device has more than one AO port, you can set the AO-2..., as same step. Basic specification of AO port:

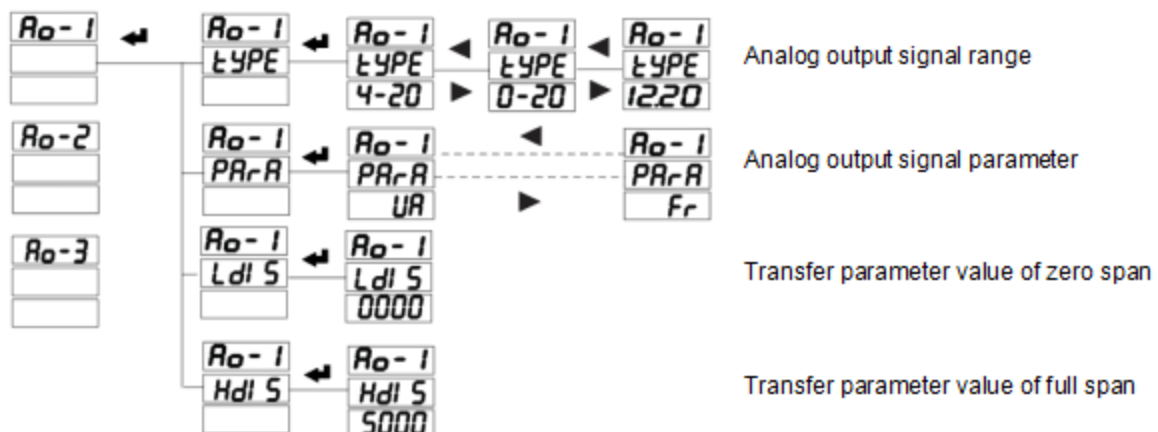

6.6. - System Setting

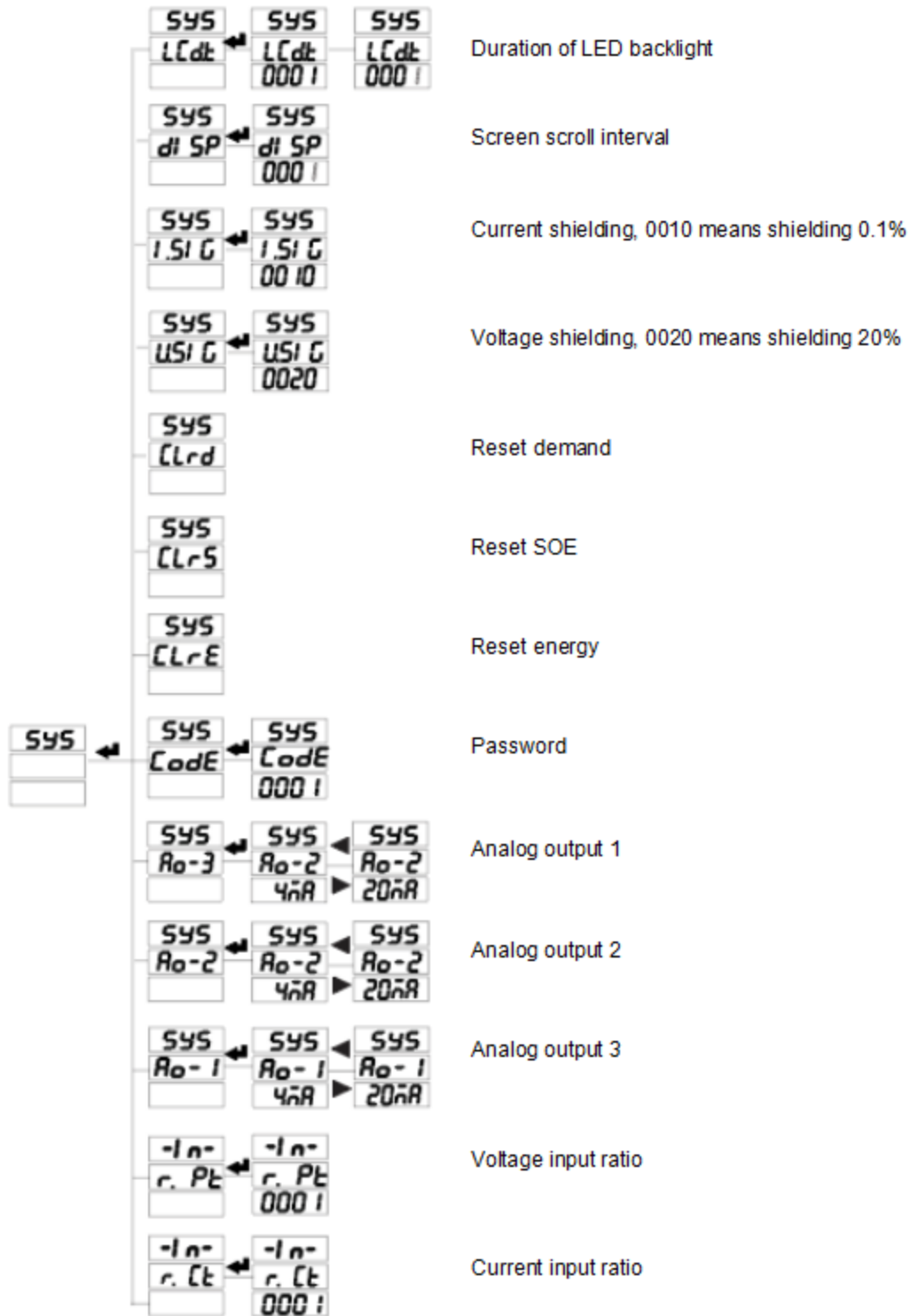

6.7. - Flowchart explanation

Layer 1	Layer 2	Layer 3	Layer 4	Description
-SYS-	CodE	(Default 0001)		Set password
	DISP	0		Select manual switching
		Display of non-zero values: 1,2....99.....		Switching time, unit is seconds. For example, displaying '1' means that the switching time between screens is 1 second.
	AO-1	4MA	(Default 0290)	Analog zero span calibration
		20MA	(Default 0850)	Analog full span calibration
	AO-2	4MA	(Default 0290)	Analog zero span calibration
		20MA	(Default 0850)	Analog full span calibration
	U.SIG	(Default 0020)		Voltage small signal shielding settings
	I.SIG	(Default 0010)		Current small signal shielding settings
CLRE			Energy reset	
LIG.t	(Default 0004)		LED backlight time settings	
-In.-	Line	3P4L,3P3L		Wiring method
	U.SCL	100V,380V		Range of input voltage signal
	I.SCL	5A,1A		Range of input current signal
	r.Pt	(Default 0001)	Range 1~9999	Set voltage signal ratio
	r.Ct	(Default 0001)	Range 1~9999	Set current signal transformation ratio
-BUS-	ADDR	(Default 0001)	Range 1~247	Set meter communication address
	BAUD	1200,2400,4800,9600 (Default 9600)		Set communication speed (baud rate)
	DATA	n.8.1, o.8.1, e.8.1 (Default n.8.1)		Set communication data format

6.8. - Menu character description

PASS	(Password) User password
-I n-	(Input) User Display data settings menu
bUS	(Bus) Communication settings menu
SYS	(System) System settings menu (for factory debugging, not open yet)
dAtA	(Data) Communication parameter setting
Addr	(Address) Local communication address setting
bAUd	(Baud) Communication baud rate
oB 1	(o.8.1) Indicates 8 data bits, 1 stop bit, odd parity
EB 1	(e.8.1) Indicates 8 data bits, 1 stop bit, even parity
nB 1	(n.8.1) Indicates 8 data bits, 1 stop bit, no parity bit
SUR E	(Sure) Confirm changes or not
Ro- 1	Analog output settings
do- 1	Channel 1 analog output setting
do- 2	Channel 2 analog output setting
PAR A	Para Corresponding parameter selection
vALU	(Value) Set the corresponding alarm value
Ldl S	Set lower alarm value
Hdl S	Set higher alarm value
HYS	Hysteresis

7. - PULSE OUTPUT

APM-96J provides 2* pulse output for the total active energy & total reactive energy.

The host / PLC / DI module can cumulative the data of both the active and reactive power energy sent by the pulse from opt coupler relay.

1). Electrical specification: voltage $VCC \leq 48V$, $I_z \leq 50mA$.

2). Pulse: 5000 imp / kWh, pulse up to 80ms.

This means: When the device detects 1 kWh, the port will generate 5000 pulse.

Note: 1 kWh energy is for secondary side energy data, if there have PT and CT accessed; primary side energy data is "1 kWh \times PT ratio \times CT ratio".

Voltage (V)	Current (A)	Pulse constant (imp / kWh)
380 or 220	5	5000
	1	20000
100	5	20000
	1	80000

Example: In measure time "T", the received total pulse is "N",
 Primary side input of voltage is 10Kv,
 Primary side input of current is 400A.
 Secondary side measurement range is 100V and 5A.

In the time "T", energy accumulated is: $N / 20000 \times 100 \times 80$

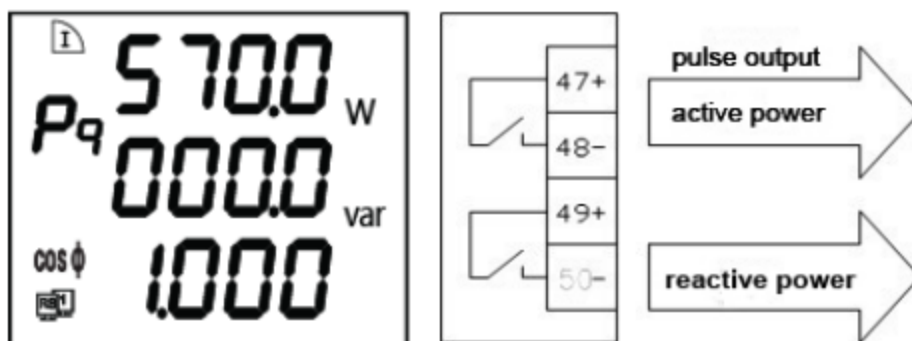

8. - COMMUNICATION INTERFACE

8.1. - Connection for RS485 BUS

The composition of the RS-485 cabling must be carried out with a meshed screen cable (minimum 3 wire), diameter of not less than 0.5mm², with a maximum distance of 1,200 m between the APM-96J and the master unit. This Bus may connect a maximum of 32pcs APM-96J...

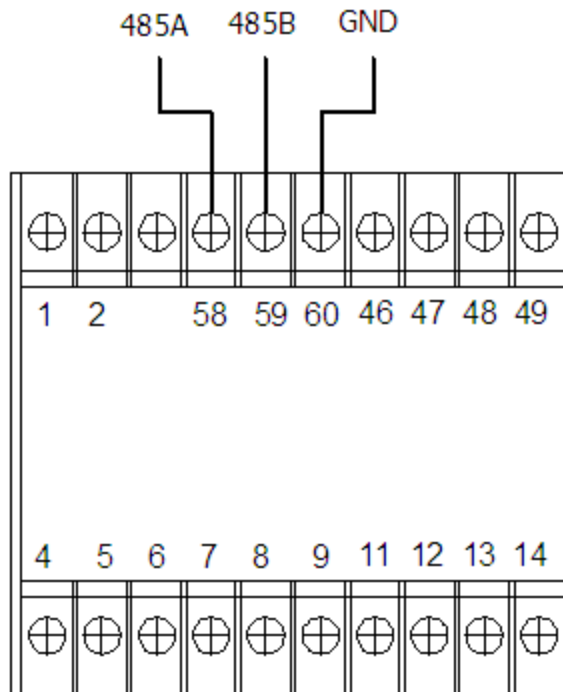

Notes:

- For communication with the master unit, user can choose RS-485 to RS-232 converter or RS485 to USB adapter to use.
- For expand the number of devices in the communication network, a signal repeater can be used.
- Full range of APM-96J... meter RS485 PIN number is 58,59,60.
- Due to product modifications or special requirements, the interface pin place may be change. For details, please refer to product label on the rear side.

8.2. - MODBUS © protocol

Modbus RTU Frame Format:

Address code	1 BYTE	<i>Slave device address 1-247</i>
Function code	1 BYTE	<i>Indicates the function codes like read coils / inputs</i>
Data code	4 BYTE	<i>Starting address, high byte Starting address, low byte Number of registers, high byte Number of registers, low byte</i>
Error Check code	2 BYTE	<i>Cyclical Redundancy Check (CRC)</i>

MODBUS FUNCTIONS:

Code	Meaning	Description
FUNCTION 01	Read Coil Status	<i>Only valid when equipped DO port</i>
FUNCTION 02	Read Input Status	<i>Only valid when equipped DI port</i>
FUNCTION 03	Reading of n Words	<i>This function permits to read all the electrical parameters of the device.</i>
FUNCTION 05	Force Single coil	<i>When DO in remote control mode can work</i>
FUNCTION 06	Preset Single holding register	<i>There is an upper limit for writing, please be sure to check the upper limit of the host computer to avoid exhausting the life of the storage machine.</i>

Note: Float data follow **IEEE754**, float low bit first, high bit next. **(CD AB)**

8.3. - Register map

8.3.1 - Basic power data-primary side

Register	Data	Byte mode		Instruction
0x00	Ua	float	2	Phase to line voltage, Unit: V
0x02	Ub	float	2	
0x04	Uc	float	2	
0x06	Uab	float	2	Phase to phase voltage, Unit: V
0x08	Ubc	float	2	
0x0a	Uca	float	2	
0x0c	Ia	float	2	Three phase current, Unit: A
0x0e	Ib	float	2	
0x10	Ic	float	2	
0x12	Pa	float	2	Individual phase active power, Unit: kW
0x14	Pb	float	2	
0x16	Pc	float	2	
0x18	$P\Sigma$	float	2	Total active power, Unit: kW
0x1a	Qa	float	2	Individual phase reactive power, Unit: kVar
0x1c	Qb	float	2	
0x1e	Qc	float	2	
0x20	$Q\Sigma$	float	2	Total reactive power, Unit: kVar
0x22	Sa	float	2	Individual phase apparent power, Unit: kVA
0x24	Sb	float	2	
0x26	Sc	float	2	
0x28	$S\Sigma$	float	2	Total apparent power, Unit: kVA
0x2a	PFa	float	2	Individual phase power factor, 0~1.000
0x2c	PFb	float	2	
0x2e	PFc	float	2	
0x30	$PF\Sigma$	float	2	Total power factor, 0~1.000
0x32	FR	float	2	Frequency, Unit:0.01Hz
0x34	Ep+	float	2	Positive active energy, Unit: kWh
0x36	Ep-	float	2	Negative active energy, Unit: kWh
0x38	Eq+	float	2	Inductive reactive power, Unit: kVarh
0x3a	Eq-	float	2	Capacitive reactive power

8.3.2 - Basic power data-secondary side

Register	Data	Byte mode		Instruction
0x100	Ua	int	1	Phase to line voltage, Unit: 0.1V
0x101	Ub	int	1	
0x102	Uc	int	1	
0x103	Uab	int	1	Phase to phase voltage, Unit: 0.1V
0x104	Ubc	int	1	
0x105	Uca	int	1	
0x106	Ia	int	1	Three phase current, Unit: 0.001A
0x107	Ib	int	1	
0x108	Ic	int	1	
0x109	Pa	int	1	Individual phase active power, Unit: W
0x10a	Pb	int	1	
0x10b	Pc	int	1	
0x10c	$P\Sigma$	int	1	Total active power, Unit: W
0x10d	Qa	int	1	Individual phase reactive power, Unit: Var
0x10e	Qb	int	1	
0x10f	Qc	int	1	
0x110	$Q\Sigma$	int	1	Total reactive power, Unit: Var
0x111	Sa	int	1	Individual phase apparent power, Unit: kVA
0x112	Sb	int	1	
0x113	Sc	int	1	
0x114	$S\Sigma$	int	1	Total apparent power, Unit: VA
0x115	PFa	int	1	Individual phase power factor, 0~1.000
0x116	PFb	int	1	
0x117	PFc	int	1	
0x118	$PF\Sigma$	int	1	Total power factor, 0~1.000
0x119	FR	int	1	Frequency, Unit:0.01Hz
0x11a	Ep+	int	2	Positive active energy, Unit: Wh
0x11c	Ep-	int	2	Negative active energy, Unit: Wh
0x11e	Eq+	int	2	Inductive reactive power, Unit: Varh
0x120	Eq-	int	2	Capacitive reactive power
0x200	DO	int	1	Bit 0~1 show channel 1 and channel 2 status 0 for open, 1 for closed
0x201	DI	int	1	Bit 0~3 show channel 1 to channel 4 status 0 for open, 1 for closed

8.3.3 - Advanced electrical parameter - primary side

Register	Data	Byte mode		Instruction
0x320	$V_{\delta+}$	float	2	Positive sequence voltage in primary side
0x322	$V_{\delta-}$	float	2	Negative sequence voltage in primary side
0x324	V_0	float	2	Zero sequence voltage in primary side
0x326	$I_{\delta+}$	float	2	Positive sequence current in primary side
0x328	$I_{\delta-}$	float	2	Negative sequence current in primary side
0x32A	I_0	float	2	Zero sequence current in primary side
0x32C	eU	float	2	Voltage unbalance, $eU = (V_{\delta-} / V_{\delta+})\%$
0x32E	eI	float	2	Current unbalance, $eI = (I_{\delta-} / I_{\delta+})\%$
0x330	Va_d	float	2	A phase voltage deviation
0x332	Vb_d	float	2	B phase voltage deviation
0x334	Vc_d	float	2	C phase voltage deviation
0x336	F_d	float	2	Frequency deviation

8.3.4- THD and individual harmonic (Max 31 times)

Register	Data	Byte mode		Instruction
0x500	THDUa	int	1	A-phase voltage THD, unit 0.1%
0x501	THDUb	int	1	B-phase voltage THD
0x502	THDUc	int	1	C-phase voltage THD
0x503	THDia	int	1	A-phase current THD, unit 0.1%
0x504	THDib	int	1	B-phase current THD
0x505	THDic	int	1	C-phase current THD
0x508-0x545	HUa	int	32	Each phase voltage individual harmonic 2~31 th , unit 0.1%
0x548-0x586	HUb	int	32	
0x588-0x5C5	HUc	int	32	
0x5C8-0x605	Hla	int	32	Each phase current individual harmonic 2~31 th , unit 0.1%
0x608-0x645	Hlb	int	32	
0x648-0x685	Hlc	int	32	
0x688	TOHDUa	int	1	Each phase voltage total odd harmonic distortion, Unit 0.1%
0x689	TOHDUb	int	1	
0x68a	TOHDUc	int	1	
0x68b	TEHDUa	int	1	Each phase voltage total even harmonic distortion, unit 0.1%
0x68c	TEHDUb	int	1	
0x68d	TEHDUc	int	1	
0x68e	THFFUa	int	1	Each phase voltage telephone harmonic form factor, unit 0.1%
0x68f	THFFUb	int	1	
0x690	THFFUc	int	1	
0x691	CFUa	int	1	Three phase voltage crest factor, unit 0.001
0x692	CFUb	int	1	
0x693	CFUc	int	1	
0x694	TOHDla	int	1	Each phase current total odd harmonic distortion, unit 0.1%
0x695	TOHDlb	int	1	
0x696	TOHDlc	int	1	
0x697	TEHDla	int	1	Each phase current total even harmonic distortion, unit 0.1%
0x698	TEHDlb	int	1	
0x699	TEHDlc	int	1	
0x69a	KFla	int	1	Three phase current k factor, unit 0.01
0x69b	KFlb	int	1	
0x69c	KFlc	int	1	

8.3.4 - Write operation function definition: Preset single holding register

Register	Data	Byte mode		Instruction
0x900	Line	int	1	Wiring method: 0: 3-phase 4-wire 1: 3-phase 3-wire 2CT 2: 3-phase 3-wire 3CT
0x901	U.SCL	int	1	Voltage range 0:100V 1:380V
0x902	I.SCL	int	1	Current range 0:1A 1:5A
0x903	PT	int	1	Voltage ratio
0x904	CT	int	1	Current ratio
0x905	Communication address	int	1	Range: 1-247
0x906	Communication baud rate	int	1	0:1200 1:2400 2:4800 3:9600 4:19200
0x907	Communication data format	int	1	0:n.8.1 1:o.8.1 2:e.8.1 3:n.8.2

Notes:

1. Not all of the data above can be read by RS485, the reading address will be unsuccessful.
2. The data can be read out depends on your multi-function meter model, please refer to the corresponding product manual before build your software.
3. Some software has different definitions of the start bit of register address, there will be offset, please add 1 for the right address. To get more info, please contact technical support tech@cqbluejay.com

8.4. - Example

Host inquiry slave device

Addr.	Func.	Data Address (high)	Data Address (low)	Data Number (high)	Data number (low)	CRC16 (low)	CRC16 (high)
0CH	03H	00H	00H	00H	06H	C4H	D5H

PC user ask upload UA, UB, UC, IA, IB, IC

Slave device answer

Addr.	Func.	Byte count	Data1 high	Data1 low	Data2 high	Data2 low	Data3 high	Data3 low
0CH	03H	0CH	03H	E8H	03H	E9H	03H	E8H
Data4 high	Data4 low	Data5 high	Data5 low	Data6 high	Data6 low	CRC16 low	CRC16 high	
13H	84H	13H	88H	13H	8AH	A6H	D6H	

Show the data:

UA=3E8H (100.0)

UB=3E9H (100.1)

UC=3E7H (99.9)

IA=1384H (4.996)

IB=1388H (5.000)

IC=138AH (5.002)

Notes:

1. Blue Jay disable the 06 function in default setting, if Activated the write command, please check the host device program to avoid the meaningless write operation, that may reduce the reduce the register working life.
2. When the write is unsuccessful, no return data from the slave device. In this addition, please re-send write inquiry again.

9. - SAFETY CONSIDERATIONS



All installation specification described at the previous chapters named:
INSTALLATION AND STARTUP, INSTALLATION MODES and SPECIFICATIONS.

Please note that with the instrument powered on, the terminals could be dangerous to touching and cover opening actions or elements removal may allow accessing dangerous parts. This instrument is factory-shipped at proper operation condition.

- ◆ The device must have a professional installation and maintenance.
- ◆ Any operation of the device, you must cut off the input signal and power.

10. - MAINTENANCE

The APM-96J meter does not require any special maintenance. No adjustment, maintenance or repairing action should be done when the instrument is open and powered on, should those actions are essential, high-qualified operators must perform them.

Before any adjustment, replacement, maintenance or repairing operation is carried out, the instrument must be disconnected from any power supply source.

When any protection failure is suspected to exist, the instrument must be immediately put out of service. The instrument's design allows a quick replacement in case of any failure.

For any inquiry about the instrument performance or any failure, contact to Blue Jay's technical service.

Blue Jay - After-sales service

E-mail: tech@cqbluejay.com