

# **BJ194E-9SY Multi-function Power Meter**

## **User Manual**

**Version: 1.5**

## Read me

**When you use BJ194E-9SY series Power Meter, be sure to carefully read this user manual, and be able to fully understand the implications, the correct guidance of operations in accordance with user manual, which will help you make better use BJ194E-9SY series Power Meter, and help to solve the various problems at the scene.**

1. Before the meter turning on the power supply, be sure that the power supply within the provisions of the instrument;
2. When installation, the current input terminal must non-open, voltage input terminals must Non-short circuit;
3. Communication terminal (RS232 or RS485) is strictly prohibited to impose high pressure;
4. Be sure the instrument wiring consistent with the internal system settings;
5. When communicating with the PC, instrument communication parameters must be consistent with the PC



- **Please read carefully before using this user manual**
- **Please save this document**

# Directory

<b>CONTENTS</b>	<b>Page</b>
1. SUMMARIZE-----	3
2. APPLICATIONS -----	3
3. FEATURES -----	4
3.1. - Electricity metering -----	4
3.2. - Specifications -----	5
4.- INSTALLATION AND START-UP -----	7
4.1. – Installation -----	7
4.2. - Connection Terminal (see label on the rear part) -----	8
4.3. - Connection Drawing for the BJ194E-9SY -----	10
5. SCREEN DISPLAY -----	12
5.1. - Panel Diagram -----	12
5.2. - Display Summary -----	12
6. OPERATING INSTRUCTIONS -----	14
7. SETUP PROCEDURE -----	15
7.1. - Password Enter -----	15
7.2. - System Display Settings -----	15
7.3. - Input Signal Selection -----	17
7.4. - Communication Preferences -----	21
7.5. - Menu Structure -----	23
7.6. - Display Character instructions -----	24
8. SAFETY CONSIDERATIONS -----	25
9. MAINTENANCE -----	25
10. TECHNICAL SERVICE -----	26

## 1. - SUMMARIZE

BJ194E-9SY Series Power Meter is used for power quality monitoring, factory automation and building automation.

It can measure all of the power parameters in power grid:

Current,	Reactive power,
Voltage,	Apparent power,
Frequency,	Energy,
Active power,	Power factor,

Also can transmit the parameter into 1 route analog outputs or 1 route pulse output. For transformers, generators, capacitor banks and motors of the distributed detection, automatic control system, on-line monitoring display.

It can replace the traditional analog or many digital measurement instruments (such as ammeter, voltmeter, power meter, power factor meter, frequency meter, etc.), greatly reduce system cost, convenient on-site wiring, improve system reliability. BJ194E-9SY Power Meter has serial port, can connection to PC; Uses Modbus to set programming and read the data.

Based on this power meters, can simply set up a monitoring system, that only use the IPC and central software.

## 2. - APPLICATIONS

- ◆ All power parameter measurement;
- ◆ Power factor measurement and control;
- ◆ Energy Measurement;
- ◆ Replace the three-phase power meter, three phase electricity transmitter;
- ◆ Transformers, generators, capacitors and electric motors distributed detection;
- ◆ Medium and low pressure systems;
- ◆ SCADA, EMS, DCS integrators.

### 3. - FEATURES

#### 3.1. - Electricity metering

By means of an internal microprocessor it simultaneously measures:

Parameter	Symbol	A-phase	B-phase	C-phase	Average
Single phase voltage	V	x	x	x	
*Phase-phase voltage	V	x	x	x	
Current	A	x	x	x	
Frequency	Hz	x	x	x	x
Power factor	Cos $\Phi$	x	x	x	x
Active power	W	x	x	x	x
Reactive power	Var	x	x	x	x
Active energy	Wh	x	x	x	x
Reactive energy	Varh	x	x	x	x

**Notes:** Phase-phase voltage is Uab, Ubc, Uca, voltage data determined by the different wiring  
 Available: **x**: Display and communications.

The 194E-9SY delivers the visualization of above listed parameters by means of LCD display. All the parameters can be simultaneously read in the screen.

#### OTHER FEATURES

- Low-size (96 x 96 mm), panel-mounting meter.
- True R.M.S. measuring system.
- Instantaneous, maximum and minimum values of each measured parameter.
- Energy measurement (indication through a lighting led)
- Have Analogue outputs, Standard output is 4~20 mA, 0~20mA, 0~5VDC (One of the above)
- RS-485 or RS-232 type communication to a PC (optional)

### 3.2. - Specifications

#### 1. - Reference standard:

Basic electricity: IEC 61557-12:2007

Active energy: IEC 62053-21:2003

Reactive energy: IEC 62053-23:2003

#### 2- Accuracy standards

Parameter	Accuracy	A phase	B phase	C phase	All	Average
Voltage	0.5%fs	V1	V2	V3		VE
Current	0.5%fs	A1	A2	A3		AE
Active Power	0.5%fs	W1	W2	W3	W	
Reactive Power	0.5%fs	var1	var2	var3	var	
Apparent power	0.5%fs	VA1	VA2	VA3	VA	
Power Factor	0.5%fs	PF1	PF2	PF3	PF	
Active Energy	1%rd				Wh	
Reactive Energy	2%rd				varh	
Frequency	0.05%rd				Hz	

#### 3. - Input

Voltage: Rated 400V (optional 100V)

Current: Rated 5A (optional 1A)

Frequency: 45-65Hz

#### 4. - Load

Voltage: <0.5VA / phase (rated 220V)

Current: <0.5VA / phase (rated 5A)

#### 5. - Overload

Current: 1.2 times rated continuous; 10 seconds for 10 times the rated

Voltage: 1.2 times the rated continuous; 10 seconds for 800V

#### 6. - Dielectric strength

IEC/EN 61010-1:2010

2kV AC RMS 1 minute, between input / output / case / power supply

**7. - EMC Test**

	standard	Test voltage
Electrostatic discharge immunity test:	IEC-61000-4-2 level 4	8Kv
Electrical fast transient burst immunity test	IEC61000-4-4 level 3	Input 1kV; Power supply 2kV
Surge (Shock) immunity test	IEC61000-4-5 level 4	common mode test voltage 4kV

**8. - Work environment**

Temperature: -20°C~ +60°C

Humidity: RH 20%~95% (No condensation)

**9. - Protection**

Panel: IP40

**10. - Storage Conditions**

Temperature: -25°C~+70°C

Humidity: RH 20%~95%

**11. - Working Power**

AC 80-265V, 45-65Hz, DC 80-380V

DC 20-60V (Optional)

Maximum power consumption 6W

**12. - Dimensions**

L × W × H =96mm×96mm×128mm

**13. - Installation hole size**

L × W = (91+0.8mm) × (91+0.8mm)

## 4.- INSTALLATION AND START-UP



The manual you hold in your hand contains information and warnings that the user should respect in order to guarantee a proper operation of all the instrument functions and keep its safety conditions. The instrument must not be powered on and used until its definitive assembly on the cabinet's door.

**If the instrument is not used as manufacturer's specifications, the protection of the instrument will be damaged.**

When any protection failure is suspected to exist (for example, it presents external visible damages), the instrument must be immediately powered off. In this case contact a qualified service representative.

### 4.1.- Installation

#### Mounting

Instrument is to be mounted on panel (cut-out  $91+0.8 \times 91+0.8 \text{ mm}$ ). All connections keep inside the cabinet.

Note that with the instrument powered on, the terminals could be dangerous to touching and cover opening actions or elements removal may allow accessing dangerous parts. Therefore, the instrument must not be used until this is completely installed.

#### Notes:

Input signal: BJ194E using a separate acquisition calculate for each measurement channel, to ensure consistent in use, for different load forms, it's a variety of connection mode.

#### A. Voltage input:

Input voltage should not exceed the rated input voltage products (100V or 400V), Otherwise, should use external CT, the input voltage to be installed in the 1A fuse.

#### B. Current Input:

Standard input current is 5A, if greater than 5A should use external CT.

Even if you are using on the CT are connecting with other instruments, wiring methods should be used in series. Before remove the current input connection, must be sure to disconnect the primary circuit or shorted secondary circuit of CT. Suggest using the terminal block, please not directly connect to CT, in order to facilitate disassembly.



**C. Please make sure that the input voltage and current corresponding to the same phase sequence, and the same direction; Otherwise, the Values and symbols will wrong!! (Power and Energy)**

The input network configuration of instrument depends on the CT number of the system:  
 in the condition of 2 CT, select the three-phase, three-lines two components;  
 in the condition of 3 CT, select the three-phase, four-lines three component mode.

Instrument connection mode, set of the instrument (programming input network NET) should be the same load wiring as measured wiring. Otherwise, the measurement instrument will lead to incorrect voltage or power.

In three-phase three-wire mode, the measurement and shows the line voltage;  
 In three-phase four-wire mode, the measurement and shows the phase voltage.

**Auxiliary power:**

BJ194E Series Power Meter with universal (AC / DC) power input, if not for a special statement, we provide the 220VAC/DC or 110VAC/DC power interface for standard products. Instruments limit work power supply: AC / DC (80-270V), please ensure that the auxiliary power can match for BJ194E series meter to prevent damage to the product.

- A. Suggest install 1A fuse in the fire line side.
- B. For the areas with poor power quality, suggest install lightning surge suppressor and rapid burst suppressor to prevent lightning strikes.

**4.2. - Connection terminal (see label on the rear part)**

***Terminal description***

Upper connection terminal

<b>1</b>	<b>2</b>		<b>58</b>	<b>59</b>	<b>60</b>	<b>46</b>	<b>47</b>	<b>48</b>	<b>49</b>
Power supply			RS485A	RS485B	GUD	AP+	AP-	RP+	RP-

- 1. \*Supply voltage input: 0 V
- 2. \*Supply voltage input: 220 Va.c.
- 58. RS-485 ( + )
- 59. RS-485 ( - )
- 60. RS-485 ( GND )
- 46. Pulse output +
- 47. Pulse output -
- 48. Analog output +
- 49. Analog output -

Lower connection terminal

**Three-phase network.- 4 wires**

<b>11</b>	<b>12</b>	<b>13</b>	<b>14</b>	<b>4</b>	<b>5</b>	<b>6</b>	<b>7</b>	<b>8</b>	<b>9</b>
Ua	Ub	Uc	Un	A-phase Current	B-phase Current	C-phase Current			

- 4. Current A-phase - S1 input
- 5. Current A-phase - S2 input
- 6. Current B-phase - S1 input
- 7. Current B-phase - S2 input
- 8. Current C-phase - S1 input
- 9. Current C-phase - S2 input
- 11. Voltage A-phase input
- 12. Voltage B-phase input
- 13. Voltage C-phase input
- 14. Neutral Voltage input

**Three-phase network.- 3 wires**

<b>11</b>	<b>12</b>	<b>13</b>	<b>14</b>	<b>4</b>	<b>5</b>	<b>6</b>	<b>7</b>	<b>8</b>	<b>9</b>
Ua	Ub	Uc	Un	A-phase Current	B-phase Current	C-phase Current			

- 4. Current A-phase - S1 input
- 5. Current A-phase - S2 input
- 6. Current B-phase - S1 input
- 7. Current B-phase - S2 input
- 8. Current C-phase - S1 input
- 9. Current C-phase - S2 input
- 11. Voltage A-phase input
- 12. Voltage B-phase input
- 13. Voltage C-phase input
- 14. Neutral Voltage input

### 4.3. - Connection Drawing for the BJ194E-9SY

a. - Three-phase network.- 4 wires (low voltage) :

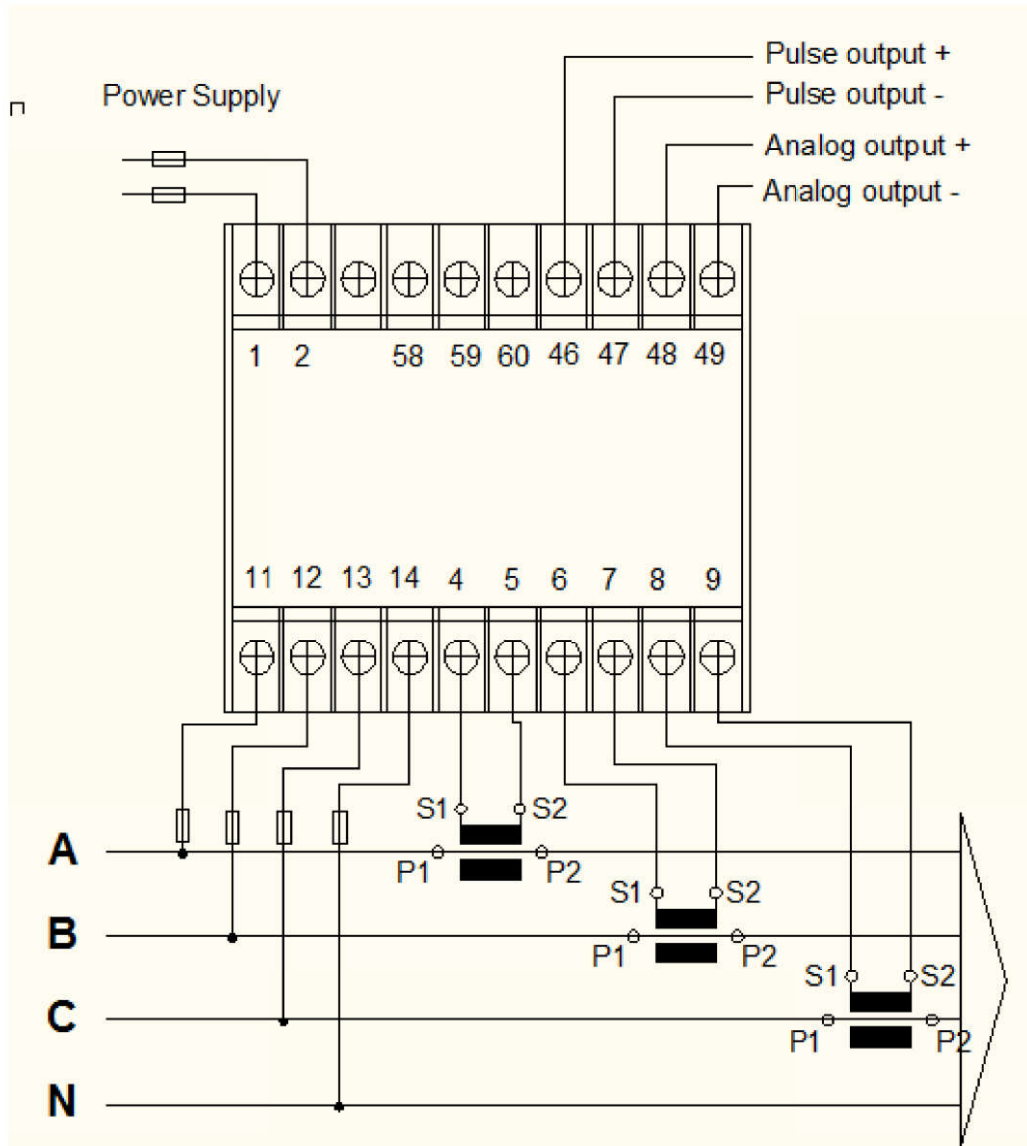

**b. - Three-phase network.- 3 wires (low voltage) :**

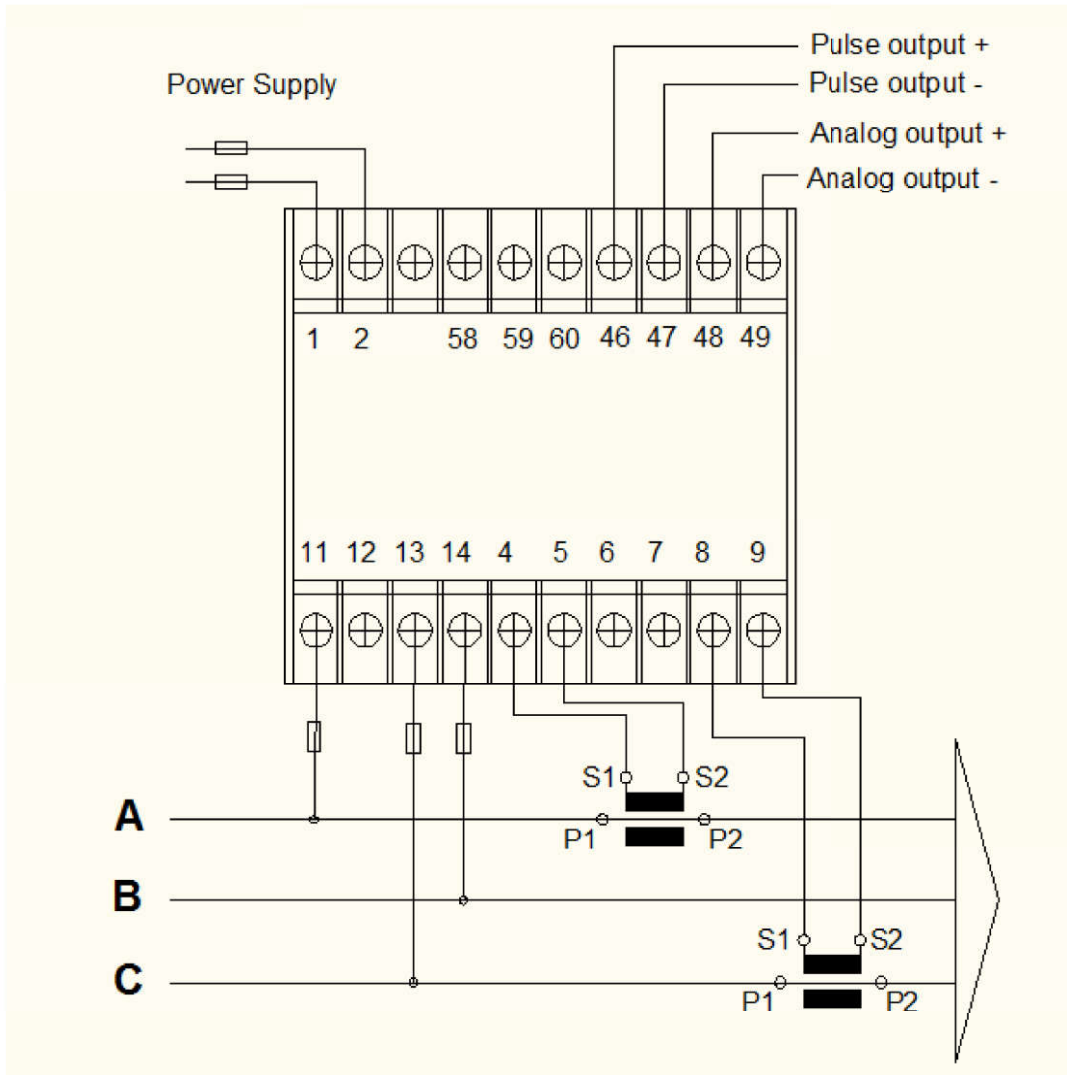

**IMPORTANT REMARK!**

If power = -0.01 is shown for any of the phases and voltage and current are not zero for this phase, check out following points:



- Assure that A, B and C phases coincide in voltage and current.
- Correct polarity? Reverse the current transformer placed at this phase.



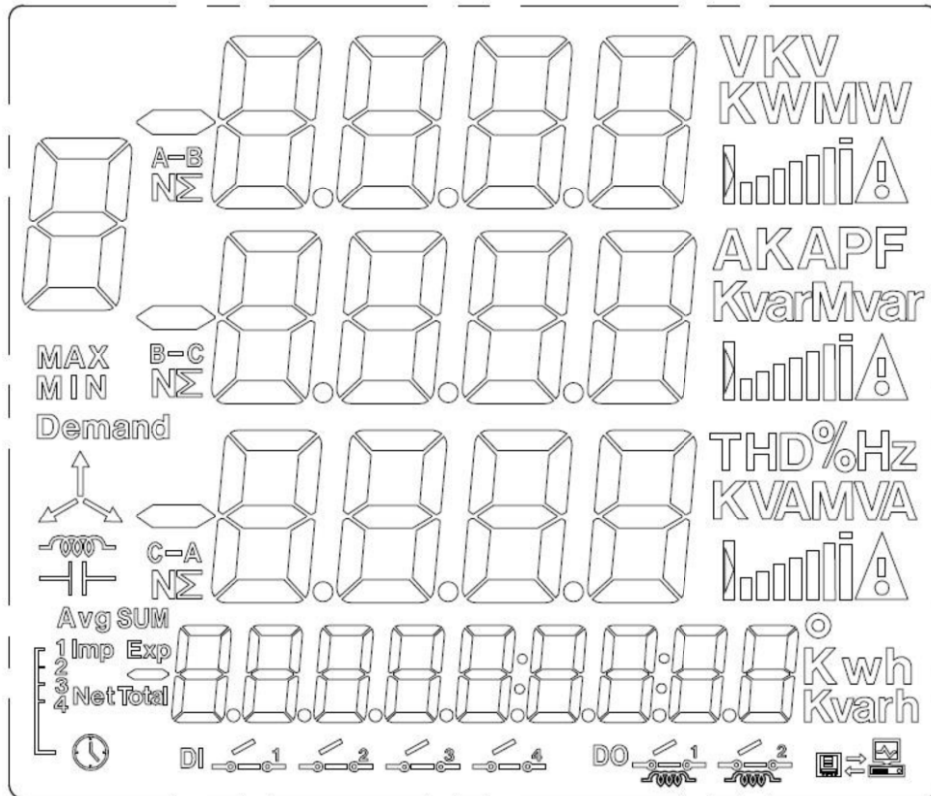



## 5. SCREEN DISPLAY

### 5.1. - Panel diagram



### 5.2. - Display Summary



<p>Four lines of “” digits in the metering area</p>	<p>Main display area: display metering data such as voltage, current, power, power factor, frequency, unbalance, phase angle, etc;</p>
<p>Nine “” digits in the bottom</p>	<p>Display energy data and real-time clock.</p>
<p>One line “” letter at the top of display panel</p>	<p>Display currant status</p>
<p>Energy icon: <b>Imp, Exp</b> <b>Net, Total</b></p>	<p><b>Imp:</b> import energy; <b>Exp:</b> export energy; <b>Net:</b> algebraic sum of Imp and Exp energy; <b>Total:</b> absolute sum of Imp and Exp energy</p>

<p>Load nature </p>	<p> : inductive load   : capacitive load</p>
<p>Communication indicator </p>	<p>No label: no communication  With label: communication</p>
<p>Prompt <b>A-B, B-C, C-A, Avg, SUM, N, Σ</b></p>	<p><b>A, B, C</b> for 3 phase A, B, C;  <b>A-B, B-C, C-A</b>, for 3 phase line-to-line AB, BC, CA;  <b>Avg</b> for average;  <b>N</b> for neutral;  <b>Σ</b> means the total</p>
<p>Measuring power direction and quadrant </p>	<p>reserved</p>
<p>DI </p>	<p>4 route digital input state</p>
<p>DO </p>	<p>Two route digital output state</p>
<p>Unit: <b>V A</b>  <b>KVA MKW</b>  <b>MKvar MKVA</b>  <b>MKWh MKvar</b>  <b>Hz PF %</b></p>	<p>Units of measurement data:  Current <b>A, KA</b>;  Voltage <b>V, KV</b>;  Active power <b>W, KW, MW</b>;  Reactive power <b>var, K var, M var</b>;  Apparent power <b>VA, KVA, MVA</b>;  Active energy: <b>KWh, MWh</b>;  Reactive energy <b>Kvarh, Mvarh</b>  Frequency: <b>Hz</b>;  Percentage : <b>%</b>.</p>

## 6. - OPERATION MODE







When the 194E-9SY is powered up, all the character will on, and meter start self- test, after some seconds, the meter is ready for operation and shows one of the available screens.



Parameters on display can be switch by pressing the key  or . LED on the right indicates the parameters shown on screen at any moment.

Whether the key  is press, the next led will be on, so indicating that for this screen CURRENT values of each phase are now shown.

Pressing again the key , the next led will be on, and the screen will shown following parameters, and so successively.

At programming display mode, press  and  to increase or decrease the value, pressing the key  and  or  and  the instantaneous at the same time, value can increase or decrease number "x10".



Pressing the "Manu" key the can open the programming menu and return to previous menu.



Pressing the "Enter" key, you exit it with saving any modification that you might have done, in menu operation press "Enter" key ,user can go to the next menu.



## 7. - SETUP PROCEDURE



The SETUP procedure of the BJ194E-9SY is performed by means of several SETUP options. Once into the SETUP, use the keyboard to select different options and enter required variables:



1. Password enters;
2. Choice of default initial screen;
3. Input signal selection;
4. Communication preferences.

### 7.1. - Password enters

A 4-figure password is required to be entered (in case that this password is not correct, will not be set on the meter).

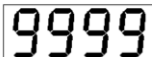
At normal display mode, press  to enter the programming mode, meter display, then press ;

Meter display “”,  
,  



Ask for the password. Press  and  to increase or decrease the number, to switch password. After password switch press  to confirm the input.

If password is correct, meter can enter next setting.

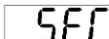

### 7.2. - System display settings

#### 7.2.1. - Choice of default initial screen

This option allows choice among **fixed or rotary screen**:  
 After password, you will see the meter show “Set” like this:



  
  

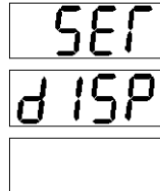

Press  to go to the level 2 menu, use  and  to choose item "DISP",

You will see the meter show "Display" like this:



Press , then enter the level 3 menu, user can use  and  to choose number 0-6, meaning as the following:

#### **0. Rotary screen display:**

Meter can show data as this cycle: Current; Voltage; Active power, Reactive Power, Power factor; Frequency; Active Energy; Reactive Energy.

All 5 screens are successively shown at intervals of 5 s.

#### **1-6 Fixed screen:**

##### **1. Three-phase current display:**

Meter display always three-phase current data in main display. And positive active energy shows in the bottom display.

##### **2. Three-phase voltage display**

Meter display always three-phase voltage data in main display. And positive reactive energy shows in the bottom display

##### **3. Power and negative active energy display:**

Meter display always three-phase power data in main display. And negative active energy shows in the bottom display.

##### **4. Power factor and negative reactive energy:**

Meter display always three-phase PF data in main display. And negative active energy shows in the bottom display.

##### **5. Apparent power display:**

Meter display always three-phase apparent power data in main display



##### **6. Reactive power and positive active energy display:**

Meter display always three-phase reactive power data in main display.

And positive positive active energy shows in the bottom display

### 7.2.2. - Clear energy counters

In “Set” menu, user can deleting energy counters.

Enter “Set” menu, in level 2 menu, use  and  to choose item “CLr.E”, meter show like this:

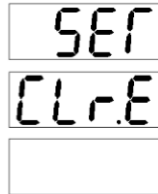

Press  to confirm clear all the energy data, meter display:

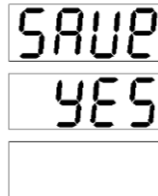

And then press  again, to save the operation and exit.



### 7.3. - Input signal selection

Press , return to level 1 menu.

In this section, user will set:

1. Input net mode;
2. Voltage measure range select;
3. Current measure range select;
4. Voltage transformation ratio;
5. Current transformation ratio.

#### 7.3.1.- Choice the input net mode

In level 1 menu, use  and  to choose item “INPT”, meter show like this:

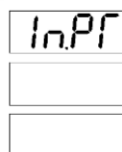

then press  , enter the level 2 menu, choose “NET”, meter show:

In.PF
nEF

then press  again, enter the level 3 menu.

Use  and  to select the right wiring mode, meter show like this:

In.PF	Or	In.PF
nEF		nEF
73.4		73.3

**N.3.4:** Three-phase four-wire, wiring reference section **4.3 a.**

**N.3.3:** Three-phase three-wire, wiring reference section **4.3 b.**

**Note:** Select the wiring mode must match actual wiring, or the reading data will go wrong.

### 7.3.2.- Choice voltage measure range

In level 1 menu of “INPT”.

Choose item “U.SCL”, meter show like this:

In.PF
U.SCL

then press  , enter the level 3 menu, user can change the voltage range:

In.PF	Or	In.PF
U.SCL		U.SCL
400		100

**400V:** Maximum measured value is 400V

**100V:** Maximum measured value is 100V

**Note:** Select a different range will affect the accuracy of measurements, if the accuracy is 0.5.

Select 100V range, means the minimum scale value is 0.5V (100 x 0.5%);

Select 400V range, means the minimum scale value is 2V (400 x 0.5%).

### 7.3.3.- Current measure range select

In level 1 menu of "INPT".

Choose "I.SCL", meter show like this:

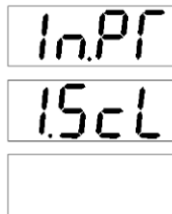

then press  , enter the level 3 menu, user can change the current range:

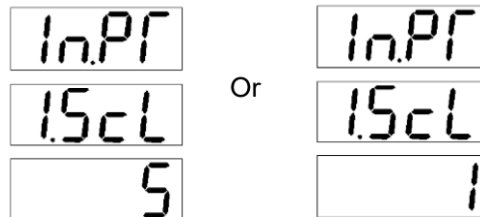

**5A:** Maximum measured value is 5A.

**1A:** Maximum measured value is 1A.

**Note:** Select a different range will affect the accuracy of measurements, if the accuracy is 0.5.

Select 1A range, means the minimum scale value is 0.005A (1 x 0.5%);

Select 5A range, means the minimum scale value is 0.025A (5 x 0.5%).

### 7.3.4- Voltage transformation ratio





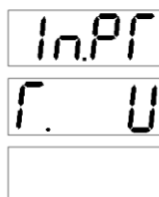

In level 1 menu of "INPT".

Choose item "T.U" , meter show like this:



then press , enter the level 3 menu, allowing us to set the current transformer.



To write or modify the value just repeatedly press  or , pressing the key  and or  and  the taneous at the same time, value can increase or decrease the number "x10", Input value is 1~9999.

**Note:** The input values represent the voltage transformer (primary side voltage) / (secondary side voltage).

Secondary side voltage is 100V or 400V; user set it at section **7.3.2**

### 7.3.5. - Current transformation ratio





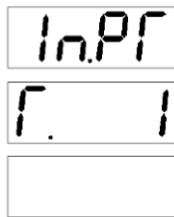

In level 1 menu of "INPT".

Choose the item "T.I", meter show like this:



then press , enter the level 3 menu, allowing us to set the current transformer.



To write or modify the value just repeatedly press  or , pressing the key  and  or  and  the instantaneous at the same time, value can increase or decrease the number "x10", Input value is 1~9999.

**Note:** The input values represent the current transformer (primary side voltage) / (secondary side current).

Secondary side current is 1A or 5A; user set it at section **7.3.3**.

## 7.4. - Communication Preferences

Press , return to level 1 menu.

In this section, user will set:

1. Meter communication address;
2. Baud rate;
3. Communication format.

**Note:** Not all the meter have communication function, please make sure your purchase meter first, if no communication mode, you can skip this section.

### 7.4.1. - Meter communication address setting





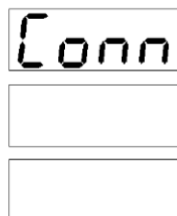

One or some BJ194...meter can be connected to a P.C. With this system we can get all the parameters in one central point of reading. The BJ194..., has a serial RS-485 or RS-232 type output (according to the model). If we connect more than one device to the same communication line (RS-485), we have to assign to each of them a different code or direction (from 1 to 247), since the P.C. needs the identification of every measuring point.

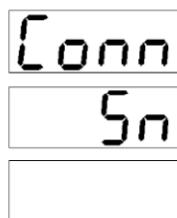
In level 1 menu, choose the item "CONN", the meter show like this:



Then press , enter the level 2 menu, choose the item "SN", meter show like this:



Then press  to level 3 menu, to write or modify the value just repeatedly press  or , pressing the key  and  or  and  the instantaneous at the same time, value can increase or decrease the number "x10", Input value is 1~247.

**7.4.2.- Communication Baud rate setting**

In level 1 menu of "CONN".

Choose item "BAUD", meter show like this:

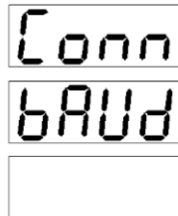

then press , enter the level 3 menu, allowing us to set the Baud rate 4800 or 9600.

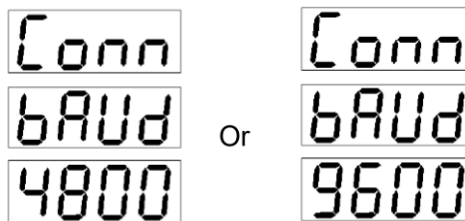

**7.4.3.- Choose communication format**

In level 1 menu of "CONN".

Choose item "Protocol", meter show like this:

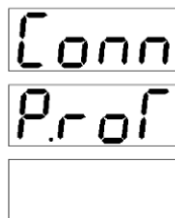

then press , enter the level 3 menu, allowing us to set the Word communication or Byte communication. **(Factory setting word communication)**

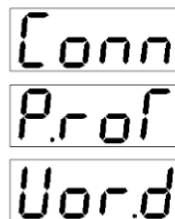

**7.5. – Menu Structure**

level 1	Level 2	Level 3	Description
(Password) <b>CODE</b>	—	Password data 9999	Only when the correct password to enter programming)
			<b>(The default password is 0001)</b>
(System set) <b>SET</b>	<b>DISP</b>	0-10	Select the display mode, automatic or individual
	<b>CLR.E</b>	—	Energy will clear after confirmed
(Signal input) <b>INPT</b>	(Net) <b>NET</b>	N.3.4 and N.3.3	Select the input signal network measurement
	(Voltage Range) <b>U.SCL</b>	400V and 100V	Select the range of measured voltage signal
	(Current Range) <b>I.SCL</b>	5A and 1A	Select the range of measured current signal
	(Voltage transformation ratio) <b>T.U</b>	1-9999	Setting voltage signal transformation ratio = 1 / 2 scale
	(Current transformation ratio) <b>T.I</b>	1-9999	Setting current signal transformation ratio = 1 / 2 scale
(Communication Parameters) <b>CONN</b>	(Address) <b>SN</b>	1-247	Instrument address range 1-247
	(Communication speed) <b>BAUD</b>	4800~9600	Baud Rate 4800、9600
	Protocol <b>PROT</b>	Word or Byte communication	Factory default communication mode for the word



### 7.6. - Display Character instructions

Abbreviation	Panel Display	Specification	Abbreviation	Panel Display	Specification
Code	0000	Code	r.l	0.000	Current Transformation Ratio
Set	0500	Set	Conn	0000	Communication
disp	0150	Disply	Sn	0050	Communication Address
b.LED	0000	Bright	baud	0000	Baud Rate
Clr.E	0000	Clear	DATA	0000	Data Format
In.pt	1000	Input	protocol	0000	Protocol Format
net	0000	Net	word	0000	Word Mode
n.3.3	0033	Three-phase Three-Line Net	byte	0000	Byte Mode
n.3.4	0034	Three-phase Four-Line Net	Wh	0000	Active Power
U.scl	0500	Voltage Range	Varh	0000	Reactive Power
r.U	0000	Voltage Transformation Ratio	Save yes	5000	Save Way
I.scl	1500	Current Range		0900	

## 8. - SAFETY CONSIDERATIONS



All installation specification described at the previous chapters named:  
**INSTALLATION AND STARTUP, INSTALLATION MODES and SPECIFICATIONS.**

Note that with the instrument powered on, the terminals could be dangerous to touching and cover opening actions or elements removal may allow accessing dangerous parts. This instrument is factory-shipped at proper operation condition.

## 9. - MAINTENANCE

The 194E does not require any special maintenance. No adjustment, maintenance or repairing action should be done when the instrument open and powered on, should those actions are essential, high-qualified operators must perform them.

Before any adjustment, replacement, maintenance or repairing operation is carried out, the instrument must be disconnected from any power supply source.

When any protection failure is suspected to exist, the instrument must be immediately put out of service. The instrument's design allows a quick replacement in case of any failure.

## 10. - TECHNICAL SERVICE

### FAQ's

1. The BJ-194E Power Meter, once cabled and connected is seen to give a correct voltage and current reading, but shows negative values for active power (generation).

This is an error with the cabling for the current transformer secondary; the direction of the transformer current has to be respected as shown in the connection diagram. The current transformers have a two face primary; the current must pass from P1 to P2 giving the result in secondary (S1 and S2) of 5 amps.

The error stems from:

**a).** The current transformers have been incorrectly installed. As a result it gives the direction of the current as passing from P2 to P1; to resolve this problem, the current transformer does not have to be dismantled and installed again, but the transformer secondary (S1 and S2) just has to be inverted.

**b).** The connection of the current secondary in the current transformers have been incorrectly connected; to resolve this problem just connect the S1 transformer secondary to the S1 on the meter and the S2 on the current transformer to the S2 on the meter

2. The BJ-194E, once cabled and connected, is seen to give an incoherent Power factor and Cos $\Phi$  reading (-0.01 or similar).

This is again a current transformer and voltage phase connection error phase A, must correspond to the current transformer installed in phase A; phase B, must correspond to the current transformer installed in phase B; and phase C, must correspond to the current transformer installed in phase C.

This connection is clearly shown on the back of the analyzer.

3. The BJ-194E is measuring in average voltage and is displaying the secondary voltage (for example 110 volts).  
Ensure that the voltage Transformer ratio has been correctly set (see section on **7.3.4**).

4. The BJ-194E does not correctly display the current reading. It shows values varying between 0 to 5 amps of current.  
Ensure that the Transformer ratio has been correctly set; once correctly set the current measurement shall be shown correctly (see section on **7.3.5**).

For any inquiry about the instrument performance or whether any failure happens, please contact to Blue Jay's technical service.

*Blue Jay - After-sales service*

*E-mail : [tech@cqbluejay.com](mailto:tech@cqbluejay.com)*