

# **3-Phase Programmable Transducer**

**BJ-QPPX**

**User Manual**

**Version: 2.1**

## Features

1. Accurate, reliable, electrical parameter measurement and analogue signal output
2. Four channels separate input, DC outputs
3. Measure Three-phase AC system
4. Output: DC analog signal (Refer to instrument labels on products)
5. With RS485 output.

## Technical parameters

Power Supply	AC/DC 85~265VAC/DC
Input	Voltage : 110/220/400VAC (..Customer specified)
	Current : 1/5A AC (Customer specified)
	Frequency: 40-65Hz
Output	DC 4 ~ 20 mA / 0~20mV / 0-5V / 0-10V (..Customer specified)
Load resistance	≤510Ω in current output ≥10KΩ in voltage output
Accuracy	≤ ±0.5%
Accuracy drift	Annual Variation < 0.2%
Response time	≤ 400 ms
Isolation	Input / output / power supply
Power consumption	AC < 3VA
Case Material	ABS fireproof materials
Insulation Voltage	AC 2KV RMS / min
Weight	About 450g
Overload voltage	2 times 10 seconds(Instantaneous), 1.2 times in last
Overload current	10 times 1 seconds(Instantaneous), 1.2 times in last
Insulation Resistance	When AC 500V , ≥100 MΩ
Dimension	87.3(W) X 132(H) X 35(D) mm
Installation	Fixed in a standard 35mm (1.38 inch) DIN rail or screwed on the cabinet
Working Condition	0 ~ 50 °C/ less than 95% RH (Non-condensing)
Storage Conditions	-20 ~ 70 °C/ less than 70% RH (Non-condensing)

### Dimension

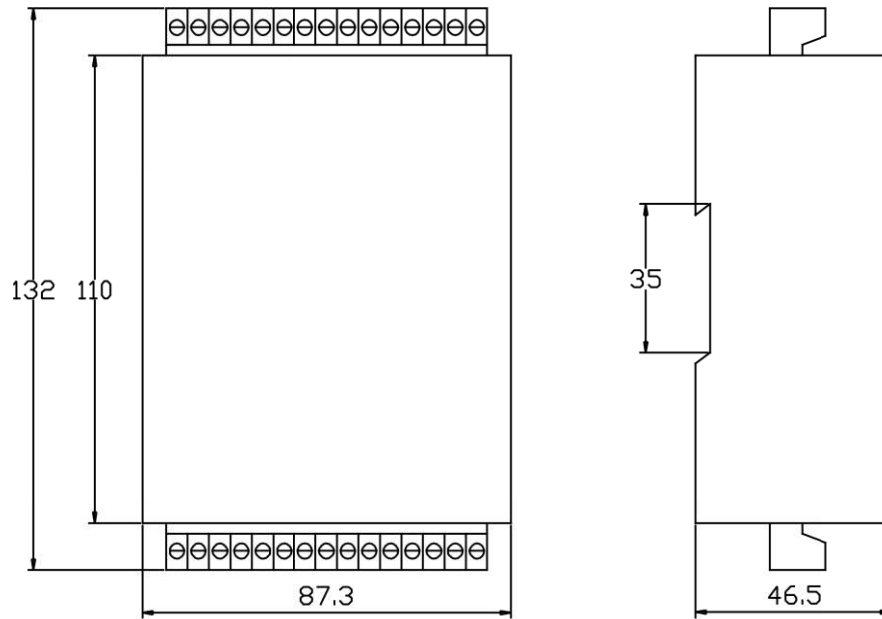

### Install mode

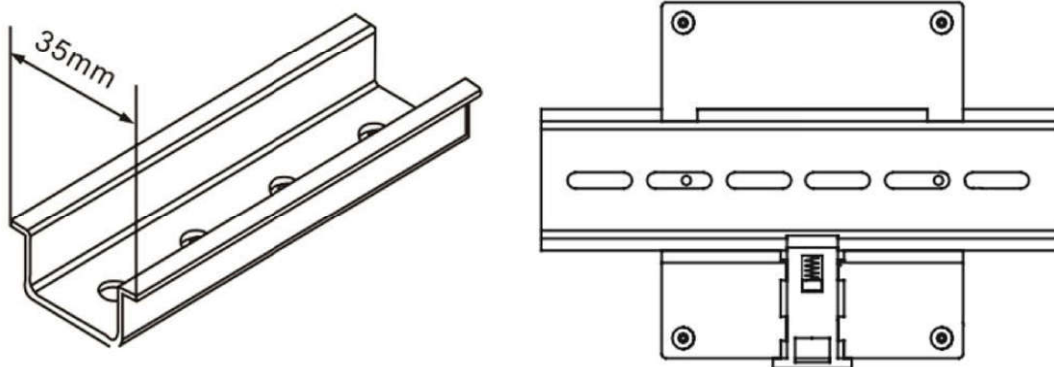

## Connection drawing

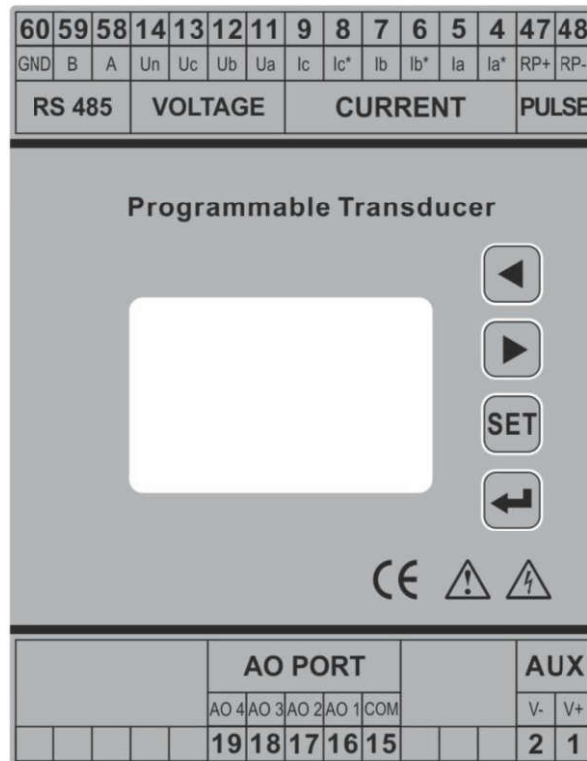

### Power Supply:

1. Supply voltage input: 220V
2. Supply voltage input: 0V

### Voltage input terminal:

- |                           |                           |
|---------------------------|---------------------------|
| 11. Voltage A-phase input | 13. Voltage C-phase input |
| 12. Voltage B-phase input | 14. Neutral Voltage input |

### Current input terminal:

- |                               |                                |
|-------------------------------|--------------------------------|
| 4. Current A-phase - S1 input | 5. Current A-phase - S2 output |
| 6. Current B-phase - S1 input | 7. Current B-phase - S2 output |
| 8. Current C-phase - S1 input | 9. Current C-phase - S2 output |

### Analog output terminal:

- |                                 |                                 |
|---------------------------------|---------------------------------|
| 15. Analog output (GND)         | 18. Analog output channel_3 (+) |
| 16. Analog output channel_1 (+) | 19. Analog output channel_4 (+) |
| 17. Analog output channel_2 (+) |                                 |

### RS485 Communication port:

- |                  |                    |
|------------------|--------------------|
| 58. RS-485 ( + ) | 60. RS-485 ( GND ) |
| 59. RS-485 ( - ) |                    |



**Pulse output:**

- 47. Pulse output (+)
- 48. Pulse output (-)

**Notes:** Listed above picture is for reference!

**Detail wiring instructions please refer to product label**

**Key operation**

- “” or “” for screen switch or value increase/decrease
- “**SET**” for menu enters or exit, (default password 0001)
- “” for enter next menu or confirm the change



**Displays the parameters**

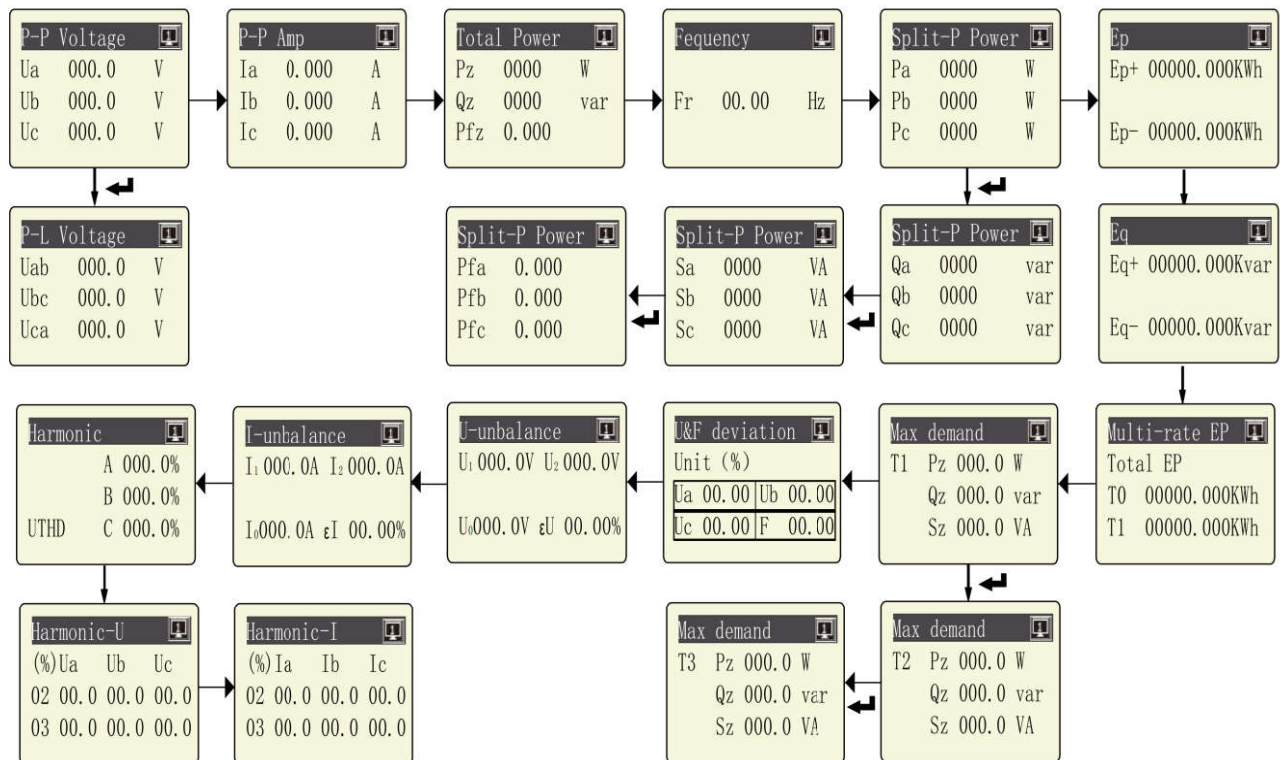

**Notes:** not all the model have the full parameter measurement, please contact our sales for more details

### Configuration menu

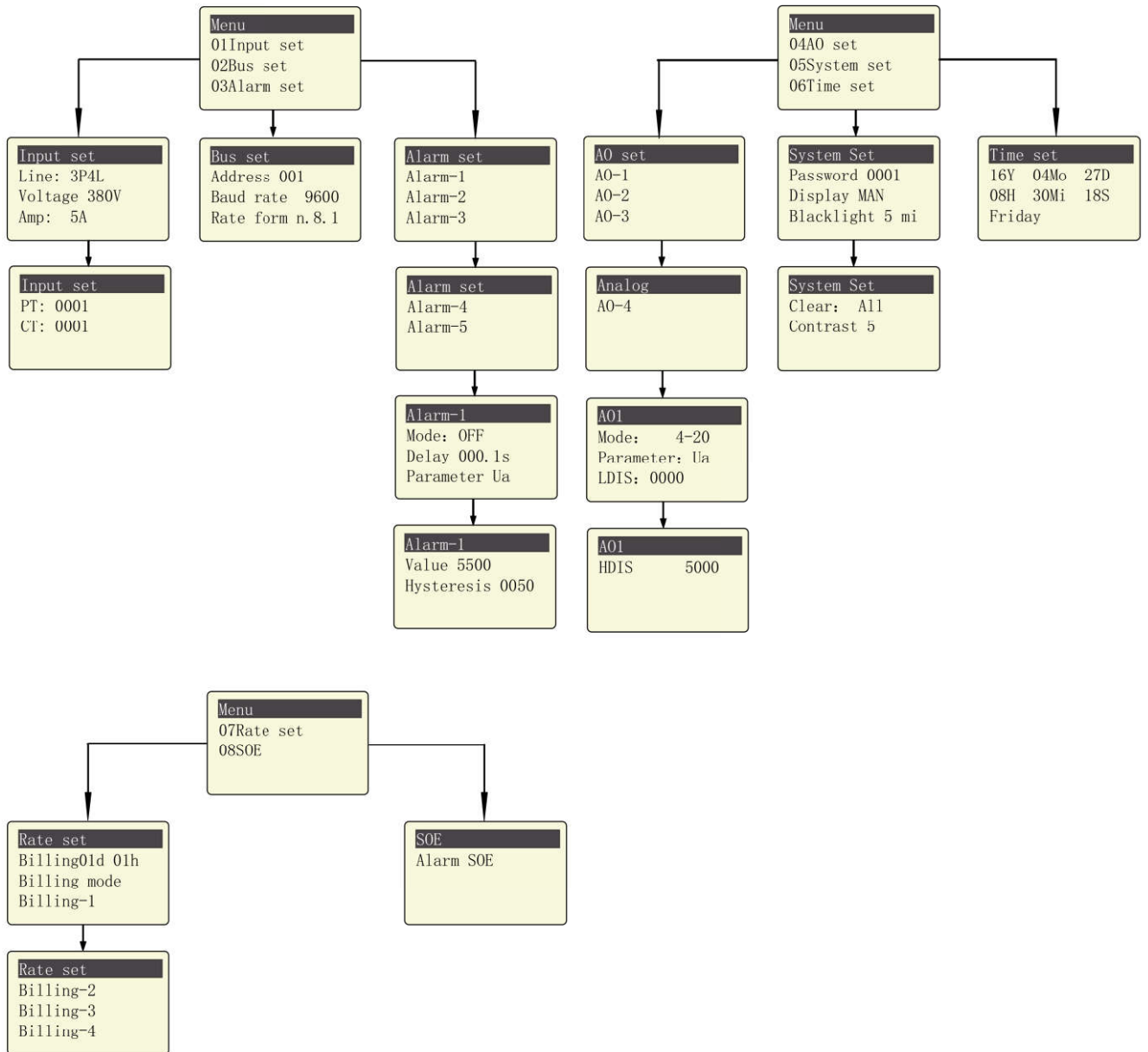

**Notes:** not all the model have the full configuration menu, please contact our sales for more details. And screen character will different based on the software version. Details meaning please refer to "Menu structure"

**Menu structure**

level 1	Level 2	Level 3	Level 4	Description
Input Setting	Wiring mode	3P4L / 3P3L2CT / 3P3L3CT		Wiring mode select
	Rated volt	100V / 380V		Voltage select
	Rated amp	5A / 1A		Current select
	PT ratio	/	1~9999	Default 0001
	CT ratio	/	1~9999	Default 0001
Comm Setting	Address	1~247	/	Default 0001
	Baud Rate	2400 / 4800 / 9600	/	Default is 4800
	Check format	n.8.1 / o.8.1 / e.8.1	/	Factory default ( <b>n.8.1</b> )
Alarm Setting	Alarm_1~5	Mode	OFF / Upper Limit / Lower Limit	Total three mode
		Delay	/	Alarm triggered time delay, Default 001.0s
		Parameter	Ua / Ub / Uc / Uab / Ubc...	Alarm triggered parameters
		Value	0~9999	Related in secondary side value, (like 100V,5A) unit as follow: Voltage: 0.1V; Current:0.001A Active power: 0.1W Reactive power:0.1VAR PF:0.001 Frequency:0.01Hz Default is 5500
		hysteresis	0~9999	Default is 0050
Digital Output	DO_1~2	Mode	Remote Alarm_1~5 ON / OFF	Total 8 mode
		Time	0~999.9	Alarm triggered time delay. In remote mode is pulse width. Default 000.1s.
Analog Output	AO_1~4	Mode	4-20mA, 0-20mA, 12-20mA ...	Default 4-20mA
		Parameter	Ua / Ub / Uc..FR	Default Ua
		Zero	0~9999	Related in secondary side value Default 0000

		Span	0~9999	Related in secondary side value Default 5000
System Settings	Password	0~9999	/	Reset user password
	Display Backlight	MAN Number 1~9	/	Manual switching, or automatic switching in 1~9sec
		1~5	/	LCD backlight duration, unit is min, default is 5
	Password	0~9999	/	Reset user password
	Clear	All / Energy / Max demand / SOE	/	Clear the record in meter
	Contrast	1~9	/	LCD display contrast, default is 5
Time setting	Year	00-99	/	Clock setting
	Month	1~12	/	
	Date	1~31	/	
	Hour	00~23	/	
	Minute	00~59	/	
	Second	00~59	/	
	Week day	1~7	/	
SOE	DI / DO status	/	/	Record last 9 listed changes
	Alarm status	/	/	Record last 40 alarms

**Notes:** not all the menu above is active, please contact Blue Jay Tech team for more help



## MODBUS © protocol

### Modbus RTU Frame Format:

<b>Address code</b>	<b>1 BYTE</b>	<i>Slave device address <b>1-247</b></i>
<b>Function code</b>	<b>1 BYTE</b>	<i>Indicates the function codes like read coils / inputs</i>
<b>Data code</b>	<b>4 BYTE</b>	<i>Starting address, high byte Starting address, low byte Number of registers, high byte Number of registers, low byte</i>
<b>Error Check code</b>	<b>2 BYTE</b>	<i>Cyclical Redundancy Check ( <b>CRC</b> )</i>
	:	

### MODBUS FUNCTIONS

<b>Code:</b>	<b>Meaning:</b>	<b>Description:</b>
<b>FUNCTION 03/04</b>	Reading of n Words	<i>This function permits to read all the electrical parameters of the BJ194...series.</i>
<b>FUNCTION 08</b>	Clear energy counters	<i>Cleared energy data by the PC (*User also can clear energy counter on meter operation, refer the <b>User Manual</b> related section)</i>
<b>FUNCTION 16</b>	Preset Multiple Registers	<i>Write value in to the relevant register</i>

## Register address table

### Basic Power Data—Primary Side

Address	Data	Byte mode		Instruction
0x00	Ua	float	2	Phase to Line Voltage, Unit: V
0x02	Ub	float	2	
0x04	Uc	float	2	
0x06	Uab	float	2	Phase to Phase Voltage, Unit: V
0x08	Ubc	float	2	
0x0a	Uca	float	2	
0x0c	Ia	float	2	Three phase Current, Unit: A
0x0e	Ib	float	2	
0x10	Ic	float	2	
0x12	Pa	float	2	Individual phase active power, Unit: kW
0x14	Pb	float	2	
0x16	Pc	float	2	
0x18	$P\Sigma$	float	2	Total active power, Unit: kW
0x1a	Qa	float	2	Individual phase reactive power, Unit: kVar
0x1c	Qb	float	2	
0x1e	Qc	float	2	
0x20	$Q\Sigma$	float	2	Total reactive power, Unit: kVar
0x22	Reserved	/	/	
0x24	Reserved	/	/	
0x26	Reserved	/	/	
0x28	$S\Sigma$	float	2	Total apparent power, Unit: kVA
0x2a	Reserved	/	/	
0x2c	Reserved	/	/	
0x2e	Reserved	/	/	
0x30	cosQ	float	2	Total power factor, 0~1.000
0x32	FR	float	2	Frequency, Unit:0.01Hz
0x34	Ep+	float	2	Positive active energy, Unit: kWh
0x36	Ep-	float	2	Negative active energy, Unit: kWh
0x38	Eq+	float	2	Inductive reactive power, Unit: kVarh
0x3a	Eq-	float	2	Capacitive reactive power

**Basic Power Data—Secondary Side**

Address	Data	Byte mode		Instruction
0x100	Ua	int	1	Phase to Line Voltage, Unit: 0.1V
0x101	Ub	int	1	
0x102	Uc	int	1	
0x103	Uab	int	1	Phase to Phase Voltage, Unit: 0.1V
0x104	Ubc	int	1	
0x105	Uca	int	1	
0x106	Ia	int	1	Three phase Current, Unit: 0.001A
0x107	Ib	int	1	
0x108	Ic	int	1	
0x109	Pa	int	1	Individual phase active power, Unit: W
0x10a	Pb	int	1	
0x10b	Pc	int	1	
0x10c	$P\Sigma$	int	1	Total active power, Unit: W
0x10d	Qa	int	1	Individual phase reactive power, Unit: Var
0x10e	Qb	int	1	
0x10f	Qc	int	1	
0x110	$Q\Sigma$	int	1	Total reactive power, Unit: Var
0x111	Reserved	/	/	
0x112	Reserved	/	/	
0x113	Reserved	/	/	
0x114	$S\Sigma$	int	1	Total apparent power, Unit: VA
0x115	Reserved	/	/	
0x116	Reserved	/	/	
0x117	Reserved	/	/	
0x118	cosQ	int	1	Total power factor, 0~1.000
0x119	FR	int	1	Frequency, Unit:0.01Hz
0x11a	Ep+	int	2	Positive active energy, Unit: Wh
0x11c	Ep-	int	2	Negative active energy, Unit: Wh
0x11e	Eq+	int	2	Inductive reactive power, Unit:Varh
0x120	Eq-	int	2	Capacitive reactive power
0x122	Ang_Ua	int	1	A phase voltage angle, unit 0.1 degrees
0x123	Ang_Ub	int	1	B phase voltage angle
0x124	Ang_Uc	int	1	C phase voltage angle
0x125	Ang_Ia	int	1	A phase current angle
0x126	Ang_Ib	int	1	B phase current angle
0x127	Ang_Ic	int	1	C phase current angle

**Writable address**

Address	Data	Byte mode		Instruction			
0x900	Wiring mode	Int	1	0: 3P4W 1: 3P3W 2CT	2: 3P3W 3CT		
0x901	Voltage range	Int	1	0: 100V	1: 380V		
0x902	Current range	Int	1	0: 1A	1: 5A		
0x903	PT ratio	Int	1	1-9999			
0x904	CT ratio	Int	1	1-9999			
0x905	RS485 address	Int	1	1-247			
0x906	Baud rate	Int	1	0: 2400 1: 4800	2: 9600 3: 19200		
0x907	Data format	Int	1	0: n.8.1 1: o.8.1	2: e.8.1 3: n.8.2		
0x908	Display control	Int	1	0-9sec, 0 for manual switch mode			
0x909	Password	Int	1	1-9999			
0x909- 0x931	Reserved	Int	1	Reserved			
0x932	AO1 mode	Int	1	0: 4-20mA 1: 0-20mA	2: 12-20mA		
0x933	AO1 parameter	Int	1	0: UA 1: UB 2: UC 3: UAB 4: UBC 5: UCA	6: IA 7: IB 8: IC 9: PA 10: PB 11: PC	12: P_total 13: QA 14: QB 15: QC 16: Q_total 17: SA	18: SB 19: SC 20: S_total 21: PF_total 22: FR
0x934	AO1 low value	Int	1	1-9999			
0x935	AO1 high value	Int	1	1-9999			
0x936	AO2 mode	Int	1	Same as AO1			
0x937	AO2 parameter	Int	1				
0x938	AO2 low value	Int	1				
0x939	AO2 high value	Int	1				
0x93a	AO3 mode	Int	1	Same as AO1			
0x93b	AO3 parameter	Int	1				
0x93c	AO3 low value	Int	1				
0x93d	AO3 high value	Int	1				
0x93e	AO4 mode	Int	1	Same as AO1			
0x93f	AO4 parameter	Int	1				
0x940	AO4 low value	Int	1				
0x941	AO4 high value	Int	1				

**Notes: following only Writable in 06 code**

Address	Data	Byte mode		Instruction
0x2000	Reset energy	Int	1	Write 0x0A0A,(2570) for reset
0x3000	Reset SOE	Int	1	
0x4000	Reset demand	Int	1	

**Device status data (optional function)**

Address	Data	Byte mode		Instruction
0x200	DO	int	1	Digital output: Bit 0~1 show channel 1and channel 2 status 0 for open, 1 for closed
0x201	DI	int	1	Digital input: Bit 0~3 show channel 1 to channel 4 status 0 for open, 1 for closed
0x20A	TIME.year	int	1	Internal RTC real time clock: Year - Month - Day - Time - minutes - seconds
0x20B	TIME.month	int	1	
0x20C	TIME.date	int	1	
0x20D	TIME.hour	int	1	
0x20E	TIME.minute	int	1	
0x20F	TIME.second	int	1	
0x210	TIME.day	int	1	

**Advanced electrical parameter (optional function)**

Address	Data	Byte mode		Instruction
0x300	Pde	float	2	Present active power demand, Unit: W
0x302	Qde	float	2	Present reactive power demand, Unit: var
0x304	Sde	float	2	Present apparent power demand, Unit: var
0x306	Pdmax	float	2	active power demand in this month
0x308	Qdmax	float	2	reactive power demand in this month
0x30a	Sdmax	float	2	apparent power demand in this month
0x30c		float	2	active power demand in last month
0x30e		float	2	reactive power demand in last month
0x310		float	2	apparent power demand in last month
0x312		float	2	active power demand in month before last month
0x314		float	2	reactive power demand in month before last month

0x316		float	2	apparent power demand in month before last month
0x318-0x31F		float	2	reversed
0x320		float	2	positive sequence voltage in primary side
0x322		float	2	negative sequence voltage in primary side
0x324		float	2	zero sequence voltage in primary side
0x326		float	2	positive sequence current in primary side
0x328		float	2	negative sequence current in primary side
0x32A		float	2	zero sequence current in primary side
0x32C		float	2	percentage of negative sequence voltage
0x32E		float	2	percentage of negative sequence current
0x330		float	2	A phase voltage deviation
0x332		float	2	B phase voltage deviation
0x334		float	2	C phase voltage deviation
0x336		float	2	Frequency deviation

**THD and Individual harmonic (Max 52 times, optional function)**

Address	Data	Byte mode		Instruction
0x500	THDUa	int	1	A-phase Voltage THD, unit 0.1%
0x501	THDUb	int	1	B-phase Voltage THD
0x502	THDUc	int	1	C-phase Voltage THD
0x503	THDia	int	1	A-phase Current THD, unit 0.1%
0x504	THDib	int	1	B-phase Current THD
0x505	THDic	int	1	C-phase Current THD
0x508-0x545	HUa	int	62	A phase voltage harmonic content ratio for 2 to 51 times, unit 0.1%
0x548-0x585	HUb	int	62	B phase voltage harmonic content ratio for 2 to 51 times, unit 0.1%
0x588-0x5c5	HUc	int	62	C phase voltage harmonic content ratio for 2 to 51 times, unit 0.1%
0x5c8-0x605	Hla	int	62	A phase current harmonic content ratio for 2 to 51 times, unit 0.1%
0x608-0x645	Hlb	int	62	B phase current harmonic content ratio for 2 to 51 times, unit 0.1%
0x648-0x685	Hlc	int	62	C phase current harmonic content ratio for 2 to 51 times, unit 0.1%
0x688	TOHDUa	int	1	A phase voltage total odd harmonic distortion, unit 0.1%
0x689	TOHDUb	int	1	B phase voltage total odd harmonic distortion, unit 0.1%

0x68a	TOHDUc	int	1	C phase voltage total odd harmonic distortion, unit 0.1%
0x68b	TEHDUa	int	1	A phase voltage total even harmonic distortion, unit 0.1%
0x68c	TEHDUb	int	1	B phase voltage total even harmonic distortion, unit 0.1%
0x68d	TEHDUc	int	1	C phase voltage total even harmonic distortion, unit 0.1%
0x68e	THFFUa	int	1	A phase voltage telephone harmonic form factor, unit 0.1%
0x68f	THFFUb	int	1	B phase voltage telephone harmonic form factor, unit 0.1%
0x690	THFFUc	int	1	C phase voltage telephone harmonic form factor, unit 0.1%
0x691	CFUa	int	1	A phase voltage crest factor, unit 0.001
0x692	CFUb	int	1	B phase voltage crest factor, unit 0.001
0x693	CFUc	int	1	C phase voltage crest factor, unit 0.001
0x694	TOHDIa	int	1	A phase current total odd harmonic distortion, unit 0.1%
0x695	TOHDIb	int	1	B phase current total odd harmonic distortion, unit 0.1%
0x696	TOHDIc	int	1	C phase current total odd harmonic distortion, unit 0.1%
0x697	TEHDIa	int	1	A phase current total even harmonic distortion, unit 0.1%
0x698	TEHDIb	int	1	B phase current total even harmonic distortion, unit 0.1%
0x699	TEHDIc	int	1	C phase current total even harmonic distortion, unit 0.1%
0x69a	KFIa	int	1	A phase current K factor, unit 0.01
0x69b	KFIb	int	1	B phase current K factor, unit 0.01
0x69c	KFIc	int	1	C phase current K factor, unit 0.01

**SOE record (Max 50 list, optional function)**

Address	Data	Byte mode		Instruction
0X700-0X7F9	SOE_1~50	int	1	Byte 0: channel      Byte 6: Day Byte 1: event        Byte 7: Time Byte 2,3: value      Byte 8: Minute Byte 4: Year         Byte 9: Seconds Byte 5: Month

0X700-0X7F9	SOE_1~50	int	1	Byte 0: event types Byte 1: event Byte 2,3: value Byte 4: Year Byte 5: Month	Byte 6: Day Byte 7: Time Byte 8: Minute Byte 9: Seconds
-------------	----------	-----	---	--	--

Byte 0 (event types)			
1:DI1_CLOSED	23:DI3_OPENED	51:Alarm-1	61: Alarm-1 over
2:DI2_CLOSED	24:DI4_OPENED	52: Alarm-2	62: Alarm-2 over
3:DI3_CLOSED	101:DO1_CLOSED	53: Alarm-3	63: Alarm-3 over
4:DI4_CLOSED	102:DO2_CLOSED	54: Alarm-4	64: Alarm-4 over
21:DI1_OPENED	103:DO3_OPENED	55: Alarm-5	65: Alarm-5 over
22:DI2_OPENED	104:DO4_OPENED		

Byte 1 (event)		
0: Remote control	115:total active power upper alarm	139:IA lower alarm
1:Alarm-1	116:QA upper alarm	140:IB lower alarm
2: Alarm-2	117:QB upper alarm	141:IC lower alarm
3: Alarm-3	118:QC upper alarm	142:IA/IB/IC3 lower alarm
4: Alarm-4	119:total reactive power upper alarm	143:PA lower alarm
5: Alarm-5	120:SA upper alarm	144:PB lower alarm
6: Forced CLOSE	121:SB upper alarm	145:PC lower alarm
7: Forced OPEN	122:SC upper alarm	146:total active power lower alarm
100: Manually disable alarm when over limit	123:total apparent power upper alarm	147:QA lower alarm
101:UA upper alarm	124:total power factor upper alarm	148:QB lower alarm
102:UB upper alarm	125:frequency upper alarm	149:QC lower alarm
103:UC upper alarm	126:DI1 closed alarm	150:total reactive power lower alarm
104:UAB upper alarm	127:DI2 closed alarm	151:SA lower alarm
105:UBC upper alarm	128:DI3 closed alarm	152:SB lower alarm
106:UCA upper alarm	129:DI4 closed alarm	153:SC lower alarm
107:UA/UB/UC upper alarm	132:UA lower alarm	154:total apparent power lower alarm
108:IA upper alarm	133:UB lower alarm	155:total power factor lower alarm
109:IB upper alarm	134:UC lower alarm	156:frequency lower alarm
110:IC upper alarm	135:UAB lower alarm	157:DI1 opened alarm
111:IA/IB/IC3 upper alarm	136:UBC lower alarm	158:DI2 opened alarm
112:PA upper alarm	137:UCA lower alarm	159:DI3 opened alarm
113:PB upper alarm	138:UA/UB/UC lower alarm	160:DI4 opened alarm
114:PC upper alarm		



**Note:**

1. Not all of the data can be read by RS485, the reading address will be unsuccessful.
2. The data can be read out depends on your transducer model, please refer to the corresponding product manual before build your software.
3. Some software has different definitions of the start bit of register address, there will be offset, please add 1 for the right address. To get more info, please contact technical support [tech@cqbluejay.com](mailto:tech@cqbluejay.com)

For any inquiry about the instrument performance or whether any failure happens, contact to Blue Jay's technical service.

*Blue Jay - After-sales service*

*E-mail : [tech@cqbluejay.com](mailto:tech@cqbluejay.com)*