

BJ-S-W1S1-K2

Temperature & Humidity Controller

User Manual



Version:1.41

Revision 2023-5

Read me

When you use BJ-S Series Digital-type Temperature & Humidity controller, be sure to carefully read this user manual, and be able to fully understand the implications, the correct guidance of operations in accordance with user manual, which will help you make better use BJ-S Series Temperature & Humidity controller, and help to solve the various problems at the scene.

1. Before the meter turn on the power supply, be sure that the power supply within the provisions of the instrument;
2. When installation, the current input terminal must be non-open, voltage input terminals must be Non-short circuit;
3. Communication terminal (RS232/RS485 or Ethernet) is strictly prohibited to impose on high pressure;
4. Be sure the instrument wiring is consistent with the internal system settings;
5. When communicating with the PC, instrument communication parameters must be consistent with the PC.



- **Please read carefully before using this user manual**
- **Please save this document**

Directory

1. - SUMMARIZE	- 3 -
2.- SPECIFICATIONS	- 4 -
3.- INSTALLATION	- 5 -
3.1- MOUNTING	- 5 -
3.2- DIN RAIL.....	- 6 -
4- OPERATION MODE.....	- 7 -
5.- SETUP PROCEDURE	- 8 -
5.1.- PASSWORD ENTER	- 8 -
5.2.- TEMPERATURE CONTROL VALUE.....	- 9 -
6.- SAFETY CONSIDERATIONS	- 12 -
7.- MAINTENANCE	- 12 -
8.- TECHNICAL SERVICE.....	- 13 -

1. - SUMMARIZE

BJ-S Series Temperature and Humidity Controller is a measurement device used on temperature and humidity control. and the humidity control module is integrated in the system, greatly improving the suitability of the equipment, obtaining the temperature and humidity change from the sensor and sending the measured data to the electronic processor. The output device will then control the temperature variation within a specific range.

With high technological content, using load control relay output, has fast output response, accurate PID parameter auto-tuning, support, Modbus communication protocol and is built-in with various output types, allowing different systems to reach a stable control status very quickly, can be used in the worst environment for long-term use, applied to the various occasion which need temperature and humidity control.

It is the ideal product to protect the normal efficient operation of power equipment and to reduce cost. And can be used in other place need of temperature and humidity control.

FEATURES

- Din(48x48mm) temperature controller
- Support multi sensor input (K, S, Wre, T, E, J, B, N, CU50, PT100)
- Wide control range -50~99°C
- Indication and control accuracy 0.5°C, high measurement
- Accuracy $\pm 0.2\%$ fs
- Use large capacity relay
- Output and alarm format can be set by user
- Built-in digital filter reduces interfere
- Self-calibration technology, keep stabilization
- 0.39" height LED, prevent dazzle, highly visible display
- Switching power supply and low consumption

Note:

Temperature range can be changed to meet user need, please confirm with Blue Jay sales team before order.

2.- SPECIFICATIONS

Basic Parameters

Power supply	AC110V-380V ± 20% 1PH 50Hz
Power consumption	≤ 1.8W
Dimension	48W x 48H x 80D mm.

Control Output

Relay output	2-Route 250VAC, 5A 1PH, resistive load
RS-485 communication	MODBUS ASCII / RTU communication protocol

Input

Temperature	-40~99°C
Temp sensor accuracy	+/-0.2 °C
Humidity	1~98%RH
Hum sensor accuracy	+/-3.0%RH
Cable length	2 m.(3m option)
Sampling rate	400 msec/per scan

Environment

Protection (TH)	Anti-containing acid, alkali, salt gas
Temperature	-10~55°C
Relative humidity	<93%, Non-condensing
Storage environment	-10~55°C ; 20 ~ 93%RH ; Noncondensing

Display

Display method	2-line x 3 character 7-segment LED display
Keypads	Menu, Enter, Increase, Decrease

3.- INSTALLATION

3.1- Mounting

Controller is to be mounted on panel (cut-out $45+0.5 \times 45+0.5 \text{ mm}$). All connections keep inside the cabinet.

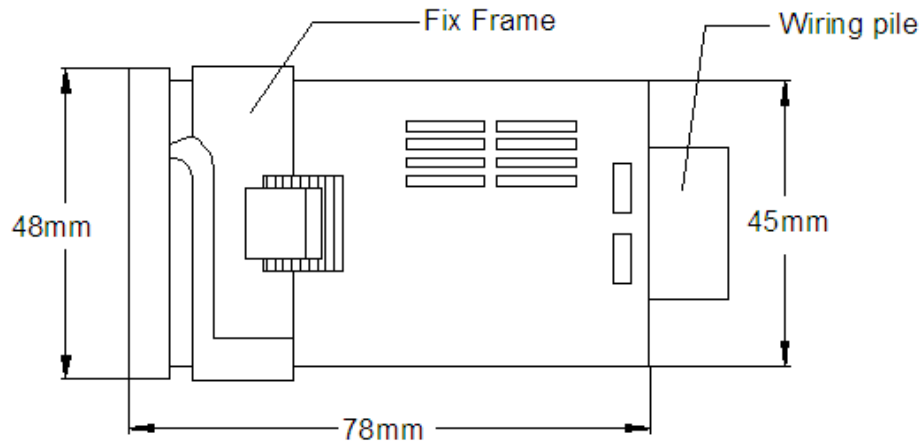

Steps:

1. Insert the controller through the panel cutout.
2. Insert the mounting bracket into the mounting groove at the top and bottom of the controller and push the mounting bracket forward until the bracket stops at panel wall.
3. Completion status

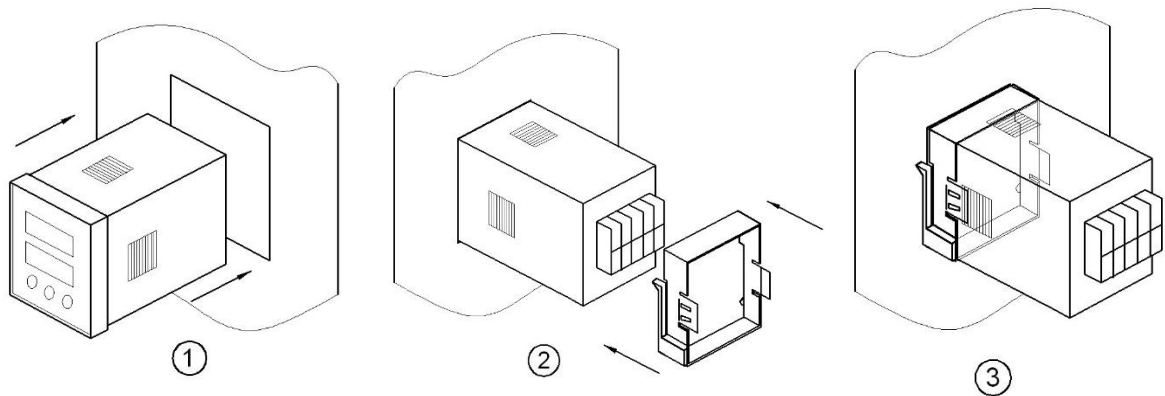

Notes:

1. The controller must not be power on until this is completely installed.
2. Panels shall not exceed 12 mm maximum thickness, if more than this range, please consider using the rail mounting

3.2- DIN Rail

Controller is using the installation socket, socket follow the 35mm DIN standard, and uses a fixed buckle to fix the controller.

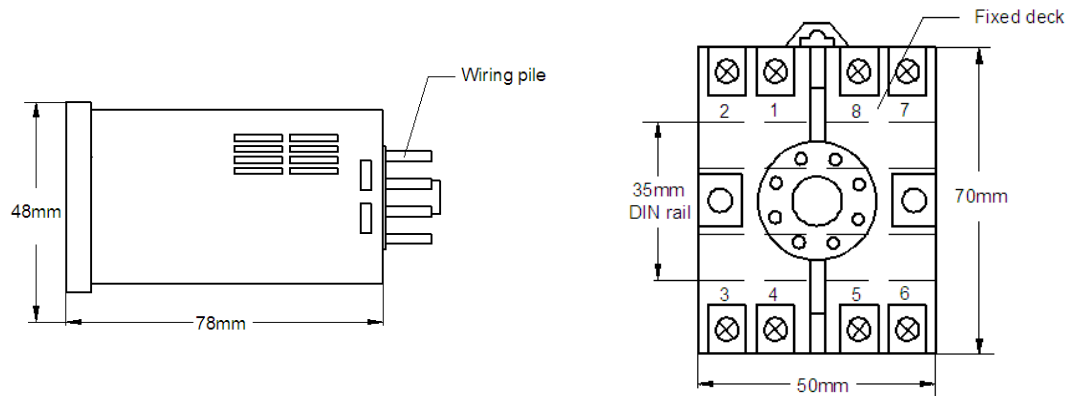

1. Place socket to a position on the DIN rail, expand the fixed buckle, and wiring.
2. Insert the controller to the bracket forward until stops at the end. (Pins will make the controller installed in the correct direction).
3. Turn the buckle down to the fixed hole.

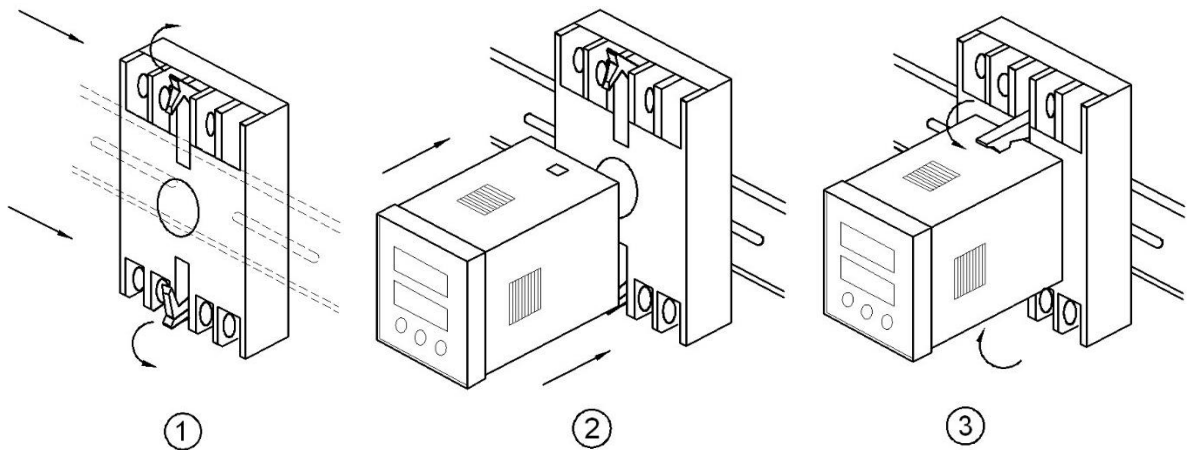

Notes:

1. Socket are of the points, please sure that the interface 1.2.7.8 is at the upwards.
2. Mounting holes with pins, if you cannot successfully install, please check the direction of socket.
3. Before the installation is completed, do not to power on.

4- OPERATION MODE

When the S series controller is powered up, all the LED indicator will on, and controller start self-test to check the sensor status. After some seconds, the controller is ready for operation and shows one of the available screens.

Note:

If there is any sensor off line, the display will show “” to indicate the sensor failure.



Up key

Press this key to increase values displayed on the display.
Hold down this key to speed up the incremental action.



Down key

Press this key to decrease values displayed on the display. Hold down this key to speed up the decrements.



Menu key

Pressing the "Menu" key the can open the programming menu and return to previous menu.



Enter key

Pressing the “Enter” key, you exit it with saving any modification that you might have done, in menu operation press “Enter” key; user can go to the next menu.

5.- SETUP PROCEDURE

The SETUP procedure of the BJ-S-W1S1-K2 is performed by means of several SETUP options. Once into the SETUP, use the keyboard to select different options and enter required variables:

1. Password enter
2. Set the temperature control value
3. Set the humidity control value
4. Set the control mode
5. Set the communication address

5.1.- Password enter

3-figure password is required to be entered (in case that this password is not correct, will not be set on the meter).

At normal display mode, press  to enter the programming mode, meter display, then



Controller display 

Ask for the password. Press  and  to increase or decrease the number, to switch

password. After password switch press  to confirm the input.

If password is correct, meter can enter next setting.



“ ”,

5.2.- Temperature control value

In this section, user can set value of temperature.

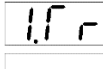

5.2.1- Set temperature control value

After password, press key  to go to the next menu, the display will show: 

Use  and  to set the temperature control value, the range is from -40 to 99.

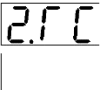
5.2.2- Set temperature hysteresis value

Then press key  again, controller ask for set temp. hysteresis, display will show: 

Use  and  to set the temp. hysteresis value, the range is from 1 to 9.

5.2.3- Set temperature compensation value

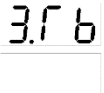
Then press key  controller ask for set temp. compensation, the display will show: 

Use  and  to set the temp. compensation value, the range is from -9.9 to 9.9.



Note:



Each piece of sensor produced by Blue Jay Technologies Co. Ltd is 100% tested to exacting specifications. But the in the normal use condition, the measurement value will be a slight deviation. For ensure the controller running well, users schedule maintenance personnel, more details please refer to [Chapter 7](#).

5.3.- Humidity control value

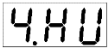

In this section, user can set value of humidity.



5.3.1- Set humidity control value

After temperature compensation set, press  to the next menu, the display will show: 

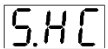



Use  and  to set the humidity control value, the range is from -40 to 99.

5.3.2- Set humidity hysteresis value

Then press  again, controller ask for set humidity hysteresis, the display will show: 

Use  and  to set the humidity hysteresis value, the range is from 1 to 9.

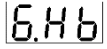
5.3.3- Set humidity compensation value

Then press  controller ask for set humidity compensation, the display will show: 

Use  and  to set the humidity compensation value, the range is from -9.9 to 9.9.

Note:

Each piece of sensor produced by Blue Jay Technologies Co. Ltd is 100% tested to exacting specifications. But the in the normal use condition, the measurement value will be a slight deviation. For ensure the controller running well, users schedule maintenance personnel, more details please refer to [Chapter 7](#).

5.4.- Control mode setting

BJ-S series controller have 9 type control mode as the following:

0. Heating type

1. Cooling type

In programming mode, press  to choose control mode setting, display will show:

Use  and  to choose control mode, the range is from 0 to 9.

5.5.- Communication setting

BJ-S series controller can use RS485 to communication of other device, so there is an address coding to locate each device, BJ-S series controller support 247 device connecting.

In programming mode, press  to choose control mode setting, display will show:

Use  and  to choose communication address, the range is from 1 to 247.

Note:

Not all the BJ-S series controller have RS485 port, please check the label on product you're your controller does not have the RS485 port, please pass in this section.

6.- SAFETY CONSIDERATIONS



All installation specification described at the previous chapters named:
INSTALLATION AND STARTUP, INSTALLATION MODES and SPECIFICATIONS.

Please note that with the instrument powered on, the terminals could be dangerous to touching and cover opening actions or elements removal may allow accessing dangerous parts. This instrument is factory-shipped at proper operation condition.

- ◆ The device must have a professional installation and maintenance.
- ◆ Any operation of the device, you must cut off the input signal and power.

7.- MAINTENANCE

The BJ-S series controller need to calibration the temperature sensor a humidity sensor in schedule maintenance.

The precision and reliability is very important. We suggested that maintain these sensors in every 3 months:

Step 1: Use a standard meter, which temperature precision is 0.1 °C and humidity precision is 3%, to measure the data near the sensors, and recorded for each parameter:

Step 2: Check the displayed real-time sampling value of T, H to compare with the standard value ST, SH.

If the temperature measurement error is more than 1 °C and the humidity measurement error is more than 5%

Please enter the setup menu, and modify **3. Tb** and **6.Hb**.

Before any adjustment, replacement, maintenance or repairing operation is carried out, the controller must be disconnected from any power supply source.

When any protection failure is suspected to exist, the controller must be immediately put out of service. The controller's design allows a quick replacement in case of any failure.

8.- TECHNICAL SERVICE

For any inquiry about the instrument performance or whether any failure happens, contact to Blue Jay's technical service.

Blue Jay - After-sales service

E-mail: tech@cqbluejay.com