

JY2000-AL DC Insulation Monitor

User Manual

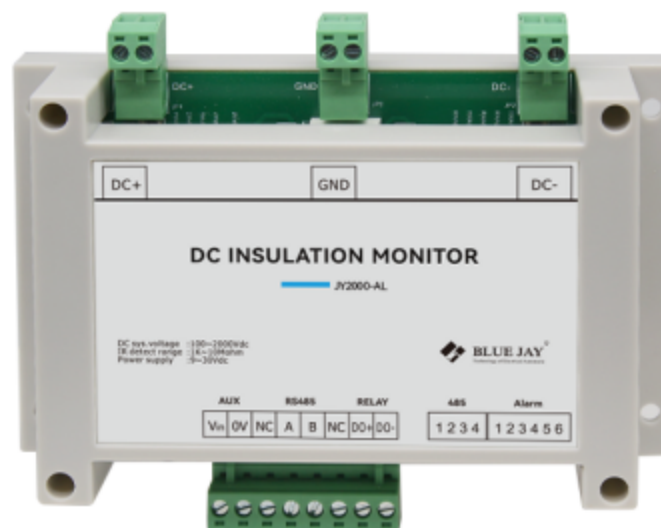

Version: 1.10

Revision: 2025.02

Read me

When you use JY2000-AL, be sure to read this user manual carefully, and be able to fully understand the implications, the correct guidance of operations in accordance with user manual, which will help you make better use of JY2000-AL, and help to solve the various problems at the scene.

1. Before turning on the power supply, be sure that the power supply within the provisions of the instrument;
2. When installation, the current input terminal must non-open, voltage input terminals must Non-short circuit;
3. Communication terminal (RS485) is strictly prohibited to impose on high pressure;
4. Be sure the instrument wiring consistent with the internal system settings;
5. When communicating with the PC, instrument communication parameters must be consistent with the PC.



- **Please read this user manual carefully**
- **Please save this document**

Directory

1. - SUMMARIZE	- 3 -
2. - FUNCTION INTRODUCTION	- 5 -
2.1. - INSULATION MONITORING WORKING PRINCIPLE	- 5 -
2.2. - INSULATION MONITORING INTERNAL SELF-TEST FUNCTION	- 5 -
2.3. - INSULATION RESISTANCE MONITORING FUNCTION	- 6 -
2.4. - RELAY OUTPUT (MODEL NUMBER WITH-A)	- 8 -
2.5. - THE LED INDICATOR	- 9 -
2.6. - DIP SWITCH CONFIGURATION BIT	- 9 -
2.7. - INSULATION RESISTANCE ALARM THRESHOLD SETTING	- 10 -
3. - TECHNICAL PARAMETERS	- 11 -
4. - INSTALLATION AND STAR UP	- 13 -
4.1. - MOUNTING	- 13 -
4.2. - WIRING METHOD	- 14 -
5. - COMMUNICATION INTERFACE	- 15 -
5.1. - CONNECTION FOR RS485	- 15 -
5.2. - COMMUNICATION PROTOCOL	- 15 -
5.3. - COMMAND SAMPLES	- 16 -
6. - SAFETY CONSIDERATIONS	- 19 -
7. - MAINTENANCE	- 19 -

1. - SUMMARIZE

JY2000-AL is a DC-to-ground insulation monitoring module based on the principle of unbalanced bridge, which has monitoring and protection functions in one. It can monitor the insulation resistance value of the positive and negative poles of the DC floating system to the ground, ranging from 1K Ω to 10M Ω ; at the same time, it can also detect the DC voltage value, ranging from 100V to 2000V.

The insulation resistance monitoring can only be realized when the DC voltage is between 100V and 2000V. When the DC voltage is less than 100V, or the insulation monitoring is not enabled, the insulation resistance read is 65535 (invalid number). When the measured value is greater than 10M Ω , the value received by the communication is 60000 (infinity).

After the insulation monitoring function is turned on, the product continues to monitor the insulation resistance in real time, and the user can read the insulation resistance value as soon as 1 second after the insulation monitoring function is turned on. For the presence of DC-to-ground capacitance, the module can realize self-adaptive monitoring of the ground capacitance below 3 μ F (the positive and negative poles to the ground capacitance are respectively below 3 μ F, and the total capacitance is below 6 μ F). When there is a ground-to-ground capacitance, the monitoring time is the longest No more than 2.5s.

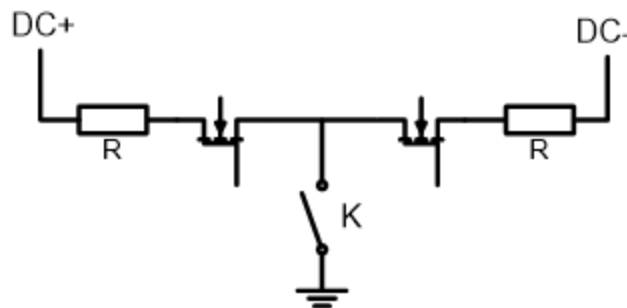

FEATURES

- High voltage grounding switch;
- Widely power supply range
- Widely insulation monitoring range (100V~2000VDC);
- Insulation monitoring equipment self-test;
- Adaptive capacitance to ground;
- Convenient parameter setting;
- Remote monitoring and management;
- Monitor positive and negative poles;
- Ground insulation resistance;
- Voltage reverse polarity alarm.

APPLICATIONS

- Insulation resistance monitoring;
- DC voltage monitoring;
- Guarantee the safety and stability of charging;
- Improvement of the efficiency and charging quality;
- Personnel and equipment security.

2. - FUNCTION INTRODUCTION

2.1. - Insulation monitoring working principle

The product adopts the bridge method, as shown in the figure on the right. After the module is powered on, the DC voltage value can be read in real time. After the module is turned on, the grounding switch K is closed, and the insulation resistance values R_{FP} and R_{FN} of the positive and negative poles to the ground can be read. The data is updated in real time, and the R_{FP} and R_{FN} data update cycle is 0.7s~2s. After the module is turned off, the grounding switch K is disconnected, and R_{FP} and R_{FN} are invalid values.

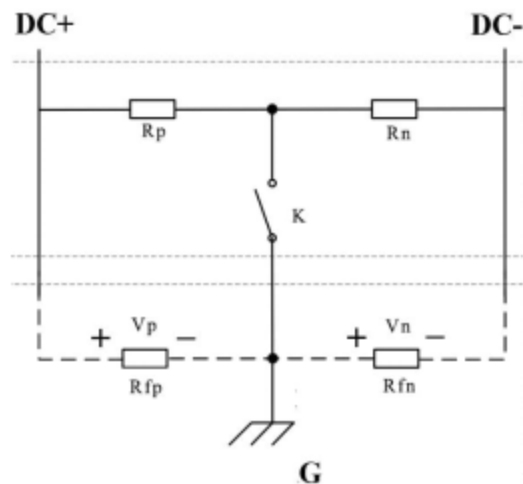

2.2. - Insulation monitoring internal self-test function

When the DC voltage is $\geq 100V$ and the insulation monitoring module is turned off, the module will automatically self-test on its internal circuit (no control required) with a self-test period of 5 seconds.

When the sampled value of the monitored bridge voltage matches the bridge resistance value, it means that the self-test is passed.

By reading Bit4 of the 0x0014 register can judge the self-test whether is passed or not. passed self-test is "1"; not passed is "0". If the self-test results are not updated, the last result will remain unchanged.

2.3. - Insulation resistance monitoring function

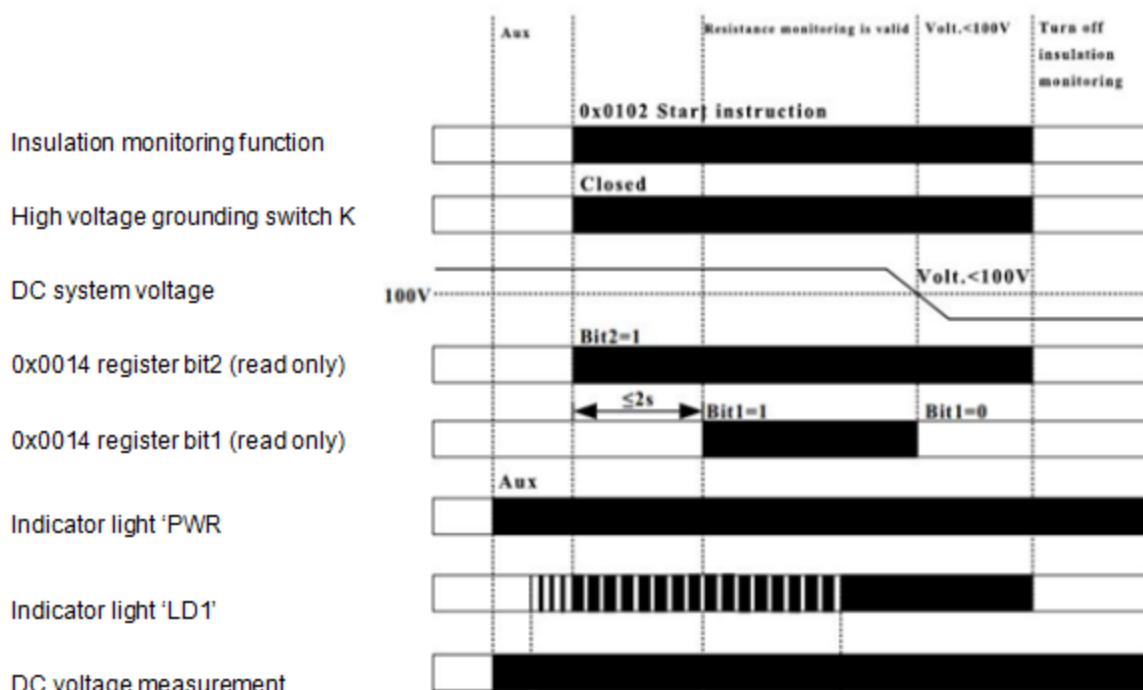

Insulation monitoring function control sequence

- After the product is powered on, the 'PWR' light turns on and the DC voltage is continuously monitored.
- Insulation monitoring can be turned on and off by writing to the 0x0102 register.
- You can determine whether the current insulation monitoring is on or off by reading bit2 of the 0x0014 register.
- After sending the opening command to the module, the grounding switch K is closed and the 'LD1' light is on; after sending the closing command to the module, the grounding switch K is open and the 'LD1' light is on.
- The conditions for the effective DC-to-ground insulation resistance in Table 2 below must be met. The insulation resistance values of 0x0012 and 0x0013 are valid values. The resistance values of 0x0012 and 0x0013 can be read; if the resistance value is $> 10M\Omega$, 0xEA60 is displayed, which is 60000; if The values of 0x0012 and 0x0013 are invalid values, that is, 0xFFFF is displayed, which is 65535.
- Users can read the insulation resistance value as soon as 0.7s~2s after turning on the insulation monitoring function. For the presence of DC capacitance to ground, the module can adaptively monitor ground capacitance below 3uF (the positive and negative capacitances to

ground are below 3uF respectively, and the total capacitance is below 6uF). When there is capacitance to ground, the monitoring time does not exceed 2s.

DC to ground resistance/voltage monitoring

Measured value	Valid/invalid	Conition	Readable
DC to ground insulation resistance value	Valid	Need to meet both: 1. Send the instruction to turn on insulation monitoring to 0x0102; 2. 0.7s~2s after turning on the module; 3. DC voltage $\geq 100V$;	0x0012 is the positive to ground resistance R_{IP} 0x0013 is the positive to ground resistance R_{IN} Bit1 of 0x0014 is "1"
	Invalid	Meet any of the following: 1. Send the turn off insulation monitoring command to 0x0102; 2. Turn on the module within 0.7s~2s; 3. DC voltage $< 100V$;	0x0012 is 0xFFFF 0x0013 is 0xFFFF Bit1 of 0x0014 is "0"

2.4. - Relay output (model number with-A)

When the insulation resistance is lower than the set threshold, the alarm relay output terminals, namely 'DO+' and 'DO-' terminals are closed, the LD2 light is on, and bit5 or bit6 of the 0x0014 register is set to '1'. Users can connect the DO+ terminal and DO- terminal in series with the electrical system to realize the protection function. The series current should be less than 3A, and the open circuit voltage should be less than 250VAC/30VDC.

when the measured insulation resistance is greater than the alarm threshold, the alarm is automatically reset, the alarm relay is disconnected, the LD2 light is off, and bit5 or bit6 of the 0x0014 register is set to '0'.

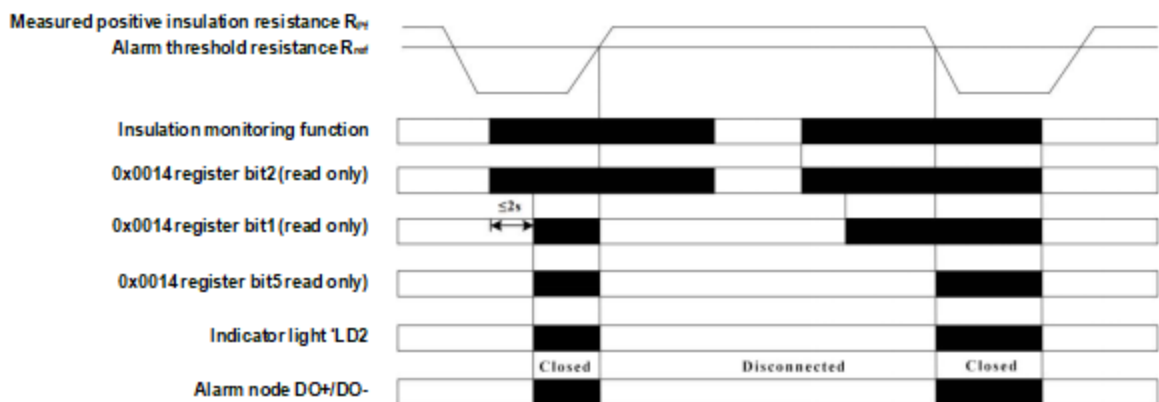

2.5. - The LED indicator

After the module is powered on, the "PWR" indicator is on.

When the insulation monitoring is power on, the "LD1" light is on, and when the insulation monitoring is power off, the "LD1" light is off.

When the insulation resistance is less than the alarm threshold, the 'LD2' light is on; otherwise, the 'LD2' light is off.

2.6. - DIP switch configuration bit

When the corresponding dial is turned to the "ON" direction, it is set to "1".

The 4-bit DIP switch of CONFIG1, the first bit sets the baud rate, 9600bps or 19200bps; the 2~4 bits set the communication address.

The 6-bit DIP switch of CONFIG2 is used to set the insulation resistance alarm threshold.

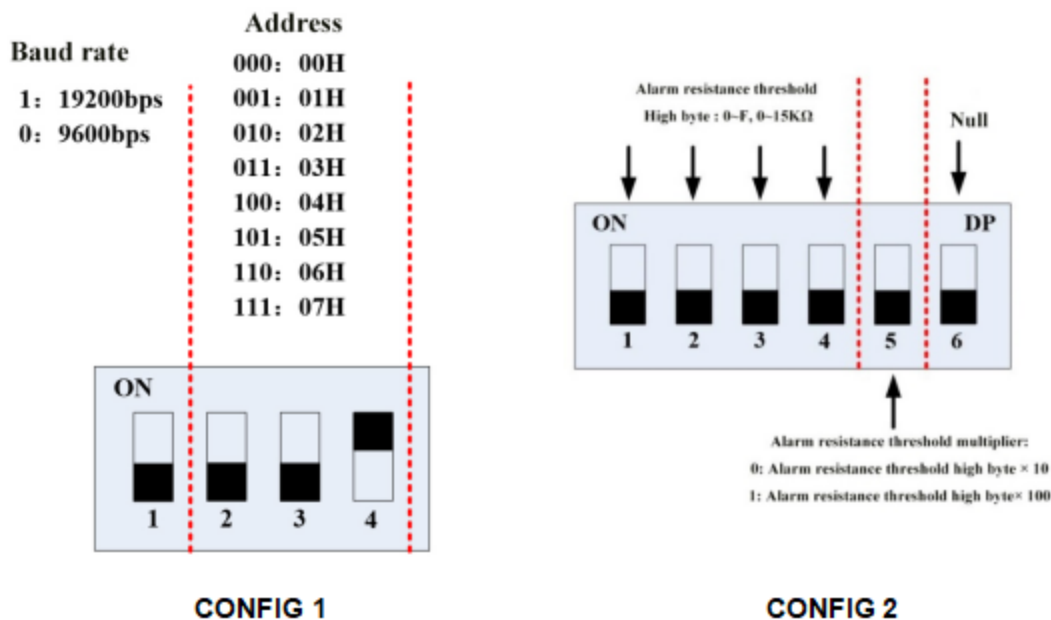

2.7. - Insulation resistance alarm threshold setting

The insulation resistance alarm threshold can be set through the 1-5 digits of the CONFIG2 dial switch, among which the 1-4 digits are the set value, and the fifth digit is the setting magnification. If the setting value is 15 and the magnification is 10, the set alarm is only 150KΩ.

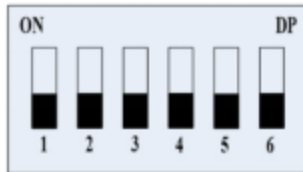

Alarm resistance value is communication setting value

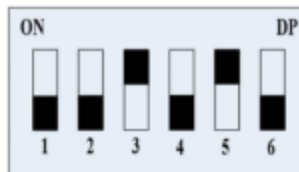

Alarm resistance threshold is 200KΩ

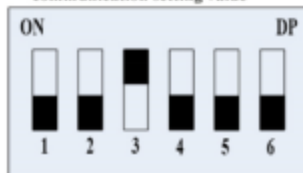

Alarm resistance threshold is 20KΩ

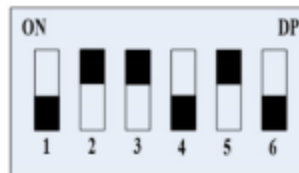

Alarm resistance threshold is 600KΩ

3. - TECHNICAL PARAMETERS

Basic parameters

Parameter	Value	
Power supply	10-30VDC	
Power supply capacity	12V: 90mA 24V: 45mA	≤ 1.5W
DC voltage range	100V~2000V	
DC voltage measurement accuracy	0-200VDC 200~2000VDC	≤2V ≤0.5%
Insulation resistance measurement range	1KΩ~10MΩ (DC System voltage:100V~2000V)	
Insulation monitoring accuracy (When :DC voltage:100V-2000V)	DC voltage: 100V~300V	≤3kΩ+10%
	DC voltage: 300V~2000V	≤3kΩ+5%
	CY range >0.3μF, Insulation resistance>1MΩ or CY range >1μF,	>10%
Insulation resistance value update time after turning on	After insulation monitoring is turned on, the time until the effective resistance value can be read for the first time	0.7s~2s
Insulation resistance value update time	Switch the insulation resistance until the module can read the switched insulation resistance value.	0.5s~3s
Alarm relay maximum switching voltage	250VAC/30VDC	
Alarm relay maximum switching current	3A	
Alarm relay contact resistance	<100mΩ	
Alarm relay insulation resistance	100MΩ	
Off-line pressure test	<2mA	
Standard	IEC 61851-23 (2014-03):2014-11	
Humidity	85%	
Storage temperature	- 55°C ~90°C	
Operating temperature	- 40°C ~75°C	

Notes:

1.When facing the ground insulation resistance R_{ISO+} and negative insulation resistance to ground R_{ISO-} , The difference is too large, Multiplier of difference>5 times, R_{ISO+} and R_{ISO-} Large resistors may not be typical values.

2. C_Y Refers to the positive and negative Y capacitance values of the system bus to ground respectively.

Other parameters

Pressure point	Maximum voltage rating	Time
DC+/DC- To GND	4200VDC/3000VAC	≤1min
Power supply +/- To GND	3500VDC/2500VAC	≤1min
RS485 A/B To GND	3500VDC/2500VAC	≤1min
DC+/DC- To Power supply +/-	4200VDC/3000VAC	≤1min
DC+/DC- TO A/B	4200VDC/3000VAC	≤1min

Note:

The power supply side (+/-), RS485(A/B), and Ground(G) should be isolated from each other.

4. - INSTALLATION AND STAR UP

4.1. - Mounting

JY2000-AL module can be installed by rail or screw. Guide rails use standard width of 35mm. Overall dimensions are shown below: (Unit: mm)

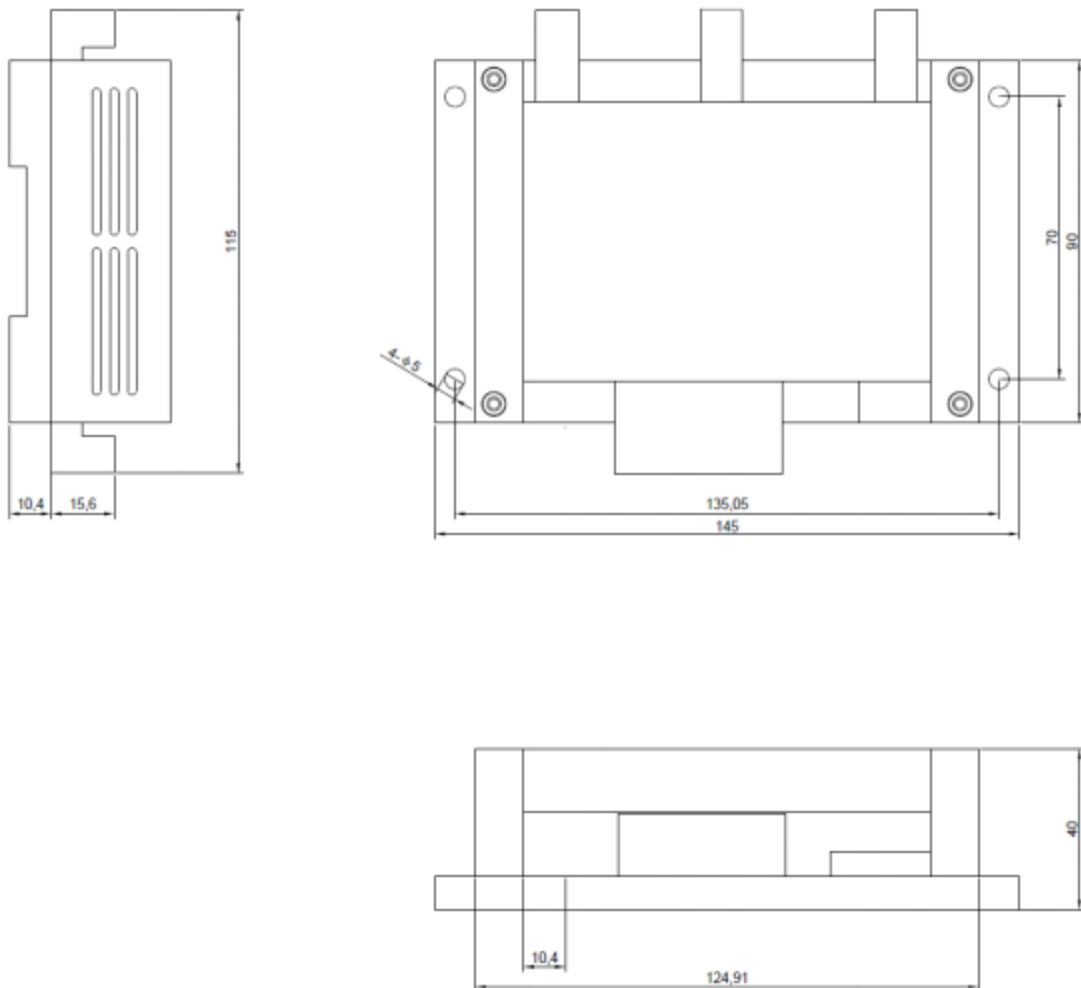

4.2. - Wiring Method

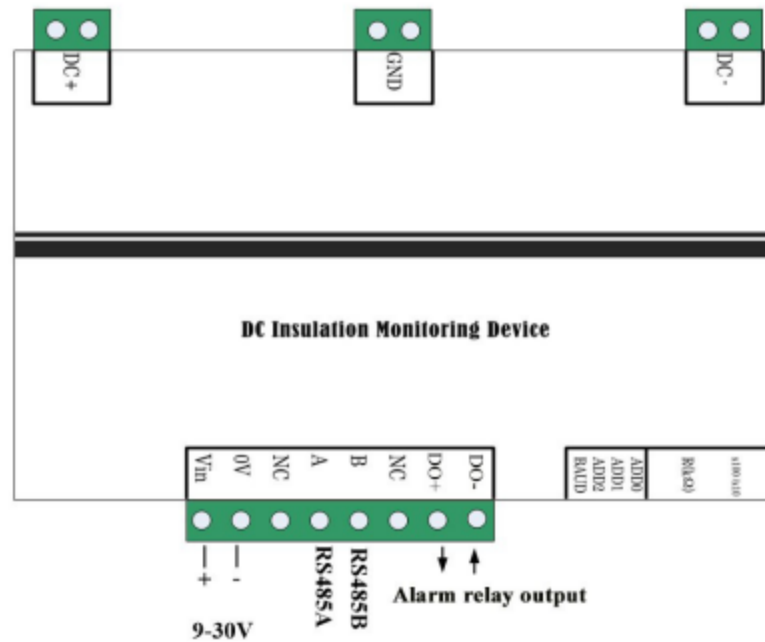

Interface	Connection mode	Definition
DC+	Positive pole of DC	DC interface 1
DC-	Negative pole of DC	
Vin	Positive pole of power supply	10-30VDC
0V	Negative pole of power supply	
A	RS485-A	
B	RS485-B	
GND	Grounding point	
DO+	Alarm relay output	
DO-	Alarm relay output	

5. - COMMUNICATION INTERFACE

5.1. - Connection for RS485

Users can send and receive data frames through the RS485 communication port, and the circuit is equipped with a 120Ω terminal resistor. The specific operation method can be found in the "RS485 communication protocol". Terminals A and B correspond to A and B output by RS485 respectively.

5.2. - Communication Protocol

JY2000-AL adopts Modbus RTU protocol, using Modbus RTU 0x03/0x06 command; baud rate, communication address, can be set by dial switch, stop bit 1, data bit 8. The time interval between each byte in the sending frame must not exceed 20ms, otherwise the frame will be cleared.

This module works in slave mode.

Modbus RTU Frame Format:

Address code	1 BYTE	<i>Slave device address 1-247</i>
Function code	1 BYTE	<i>Indicates the function codes like read coils / inputs</i>
Data code	4 BYTE	<i>Starting address, high byte Starting address, low byte Length of registers, high byte Length of registers, low byte</i>
Error Check code	2 BYTE	<i>Cyclical Redundancy Check (CRC)</i>

MODBUS FUNCTIONS:

Code	Meaning	Description
FUNCTION 03	Read hold register	<i>This function permits to read all the electrical parameters</i>
FUNCTION 06	Write single register	<i>This function permits to write a value into a single holding register.</i>

5.3 - Command samples

5.3.1 - Read Command (Function x 03)

Sample 1 Read the DC bus voltage and positive and negative insulation resistance to the ground(read 4 registers)

Host inquiry:

01 03 00 10 00 04 45 CC

Slave response:

01 03 08 07 00 D0 02 58 EA 60 02 58 11 4F

Notes:

Read the DC voltage 0X07D0(200V),
The positive insulation resistance 0XEA60 (infinite),
The negative insulation resistance 0X0258 (600KΩ).

Notes:

Only when the DC voltage is between 100V~1000V, Insulation resistance monitoring can be realized. If DC voltage is low than 100V, or it is turned on within a short time, the insulation resistance read is 0xFFFF (means invalid number).

If the read insulation resistance value is a valid number, the insulation resistance value monitoring range is between 1KΩ~10MΩ. When the measured value is greater than 10MΩ, the value received by the communication is 0xEA60 (means infinity).

Sample 2 Read IO status

Host inquiry:

01 03 00 14 00 01 C4 0E

Slave response:

01 03 02 00 94 B9 EB

0x0094=0000 0000 1001 0100,
Bit7=1 means the bus voltage is reversed.
Bit2=1 The insulation monitoring function is turned on.
Bit1=0 The insulation resistance value is invalid.
Bit4=1 means self-test passed,

5.3.2 - Write Command (Function x 06)

Sample 1 Turn on insulation monitoring:

Host inquiry:

01 06 01 02 00 11 E9 FA

Slave response:

01 06 01 02 00 11 E9 FA

Sample 2 Turn off insulation monitoring:

Host inquiry:

01 06 01 02 00 00 29 F6

Slave response:

01 06 01 02 00 00 29 F6

5.3.3 - Register Map

Function	Register	Data	Description
0x03	0x0010	DC bus voltage	Unit 0.1V,16-bits 01 03 00 10 00 01 85 CF
	0x0012	Insulation resistance of DC+ to Ground	Unit K Ω , take an integer 01 03 00 12 00 01 24 0F (0xFFFF: invalid value; 0xEA60: resistance value greater than 10M Ω)
	0x0013	Insulation resistance of DC- to Ground	Unit K Ω , take an integer 01 03 00 13 00 01 75 CF (0xFFFF: invalid value; 0xEA60: resistance value greater than 10M Ω)
	0x0014	Status bit	Refer to: chapter 5.3.1 01 03 00 14 00 01 C4 0E
	0x001A	Read version number	0x52A2 01 03 00 1A 00 01 A5 CD
0x06	0x0102	Insulation monitoring control	Turn on insulation monitoring function 01 06 01 02 00 11 E9 FA
			Turn off insulation monitoring function 01 06 01 02 00 00 29 F6

0x0014 Register bit definition

Bit	Definition	
bit15~bit8	Null	Null
bit7	Bus voltage reverse connection alarm	0: There is no reverse connection of DC voltage or the reverse connection voltage is less than 100V
		1: DC reverse voltage is greater than 100V
bit6	Negative insulation failure	0: No fault in negative pole insulation
		1: Negative pole insulation fault, that is negative pole insulation resistance is less than the set threshold
Bit5	Positive insulation failure	0: No fault in positive pole insulation
		1: positive pole insulation fault, that is negative pole insulation resistance is less than the set threshold
bit4	Self-test result bit	1: Self-test passed
		0: Self-test not passed or self-test is invalid
bit2	Insulation monitoring function turned on or off	0: Insulation monitoring function turned off and the grounding switch K is disconnected.
		1: Insulation monitoring function turned on and the grounding switch K is closed.
bit1	Insulation resistance monitoring valid or invalid	0: Insulation resistance monitoring has not been completed, and the resistance value is an invalid value.
		1: Insulation resistance monitoring is valid and the resistance value can be read

6. - SAFETY CONSIDERATIONS



All installation specification described at the previous chapters named: **INSTALLATION AND STARTUP, INSTALLATION MODES and SPECIFICATIONS.**

Please note that with the instrument powered on, the terminals could be dangerous to touching and cover opening actions or elements removal may allow accessing dangerous parts. This instrument is factory-shipped at proper operation condition.

- ◆ The device must have a professional installation and maintenance
- ◆ Any operation of the device, you must cut off the input signal and power;

7. - MAINTENANCE

The JY2000-AL does not require any special maintenance. No adjustment, maintenance or repairing action should be done when the instrument is open and powered on, should those actions are essential, high-qualified operators must perform them.

Before any adjustment, replacement, maintenance or repairing operation is carried out, the instrument must be disconnected from any power supply source.

When any protection failure is suspected to exist, the instrument must be immediately put out of service. The instrument's design allows a quick replacement in case of any failure.

For any inquiry about the instrument performance or any failure, contact to Blue Jay's technical service.

Blue Jay - After-sales service

E-mail: tech@cqbluejay.com