

PD3000

Partial Discharge Monitor

User Manual



Version:1.13

Revision 2024.06

Read me

When you use PD3000 partial discharge monitor, be sure to read this user manual carefully, and be able to fully understand the implications, the correct guidance of operations in accordance with user manual, which will help you make better use of PD3000 partial discharge monitor, and help to solve the various problems at the scene.

1. Always keep safe distance between the high voltage part and the instrument, probe and operator.
2. Measurements must not be taken when thunderstorms are nearby.
3. Do not operate the instrument or accessories in explosive atmospheres.
4. After the battery alarm of the instrument, please turn off the power to charge.
5. Do not open the instrument without permission, this will affect the warranty of the product. The factory is not responsible for self-disassembly.
6. When the instrument is transported, it should avoid rain erosion and prevent collision and falling.
7. When storing and keeping the instrument, attention should be paid to the ambient temperature and humidity, and it should be protected from dust, moisture, shock, acid, and corrosive gas.



- **Please read this user manual carefully**
- **Please save this document**

Directory

1. - SUMMARIZE	- 3 -
2. - TEST PRINCIPLE	- 4 -
3. - SENSOR INTRODUCTION	- 6 -
3.1. - EXTERNAL SENSORS (ULTRASONIC AND TEV)	- 6 -
3.2. - OPTIONAL EXTERNAL SENSORS (AE, HFCT, UHF)	- 9 -
4. - TECHNICAL SPECIFICATION	- 10 -
5. - INSTALLATION AND START-UP	- 11 -
5.1. - INSTALLATION DIMENSIONS (UNIT: MM)	- 11 -
5.2. - CONNECTION TERMINAL (SEE LABEL ON THE REAR PART)	- 11 -
6. - SCREEN DISPLAY	- 12 -
6.1. - PANEL DIAGRAM	- 12 -
6.2. - PANEL DEFINITION	- 12 -
7. - OPERATION MODE	- 13 -
8.- MENU INTRODUCTION	- 14 -
8.1. - SETTING	- 14 -
8.2. - ALARMEVENT REVIEW	- 18 -
8.3. - HELP INFORMATION	- 18 -
9.- COMMUNICATION INTERFACE	- 19 -
9.1. - MODBUS © PROTOCOL	- 19 -
9.2. - REGISTER MAP	- 20 -
10.- SAFETY CONSIDERATIONS	- 21 -
11.- TECHNICAL SERVICE	- 21 -

1. - SUMMARIZE

Partial discharge is a kind of pulse discharge, which will produce a series of physical phenomena and chemical changes such as light, sound, electrical and mechanical vibration in the interior and surrounding space of power equipment. These various physical and chemical changes accompanied by partial discharge can provide detection signals for monitoring the internal insulation state of power equipment. When insulation defects appear inside high-voltage electrical equipment, it will be accompanied by the generation of partial discharge signals. Through the detection and analysis of partial discharge signals, it can be judged whether there is a hidden danger of insulation inside the high-voltage electrical equipment, and the further expansion of potential accidents can be prevented.

PD3000 partial discharge monitor can be used with UHF sensor, TEV sensor, Ultrasonic sensor and online detection of partial discharge of high voltage equipment such as transformers, high voltage switchgear, and cable joints. Easy to carry, fast measurement, strong anti-interference ability, easy to use on site.

FEATURES

- Waveform data recording function.
- Non-intrusive detection method.
- Alarm multi-level threshold setting.
- Sensor detects TEV and audible ultrasonic.
- Automatic PD data acquisition and analysis.
- Rapid detection of partial discharge conditions.
- 2*DO NC & NO contact for external alarm trig.
- Joint detection of partial discharge signals by transient earth waves.
- Anti-interference performance and measurement accuracy.
- RS 485, Modbus-RTU, SCADA systems.

APPLICATIONS

- Ensure the safety of personnel and equipment.
- Improve equipment reliability and safety.
- Evaluate the performance parameters and electrical characteristics of the equipment.
- Monitoring of transformers, cables, switchgear, busbars.
- Data analysis to predict equipment failure and lifetime.
- Monitor equipment operating status and prevent equipment accidents.

2. - TEST PRINCIPLE

This system monitors the insulation status of the switchgear by simultaneously monitoring transient low voltage (TEV, also known as ground wave) and ultrasonic signals generated by partial discharge. The monitoring mechanism is shown in the following figure:

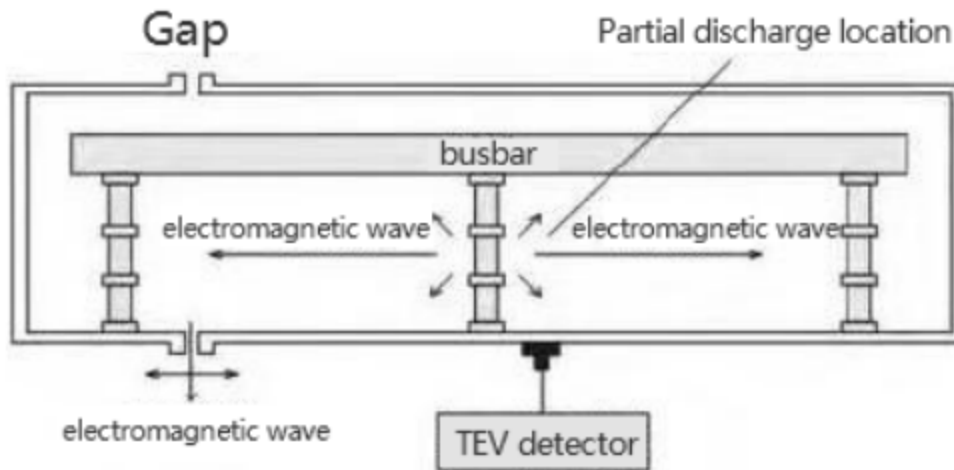

Figure 1. TEV detection mechanism

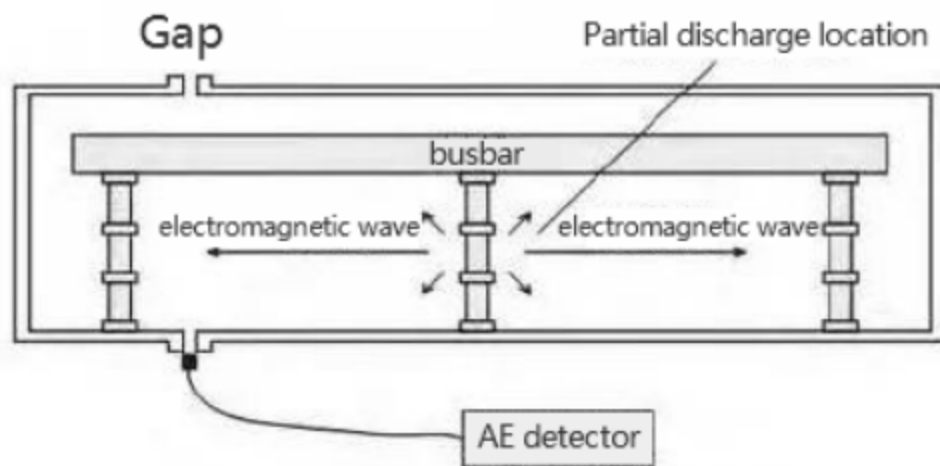

Figure 2. Ultrasonic detection mechanism

The overall structure of the system consists of four parts: sensors, acquisition devices, data gateways, and servers. This system uses a combination of ultrasonic and TEV methods to detect the partial discharge condition of medium and high voltage switchgear to determine the insulation status of the equipment. Each acquisition device collects one TEV sensor and one ultrasonic sensor signal at a set time interval, analyzes and processes the collected signal, and sends the detection data to the data gateway through wireless lora. The data gateway selects RJ45 or 4G network to transmit the data to the background data center according to the on-site situation.

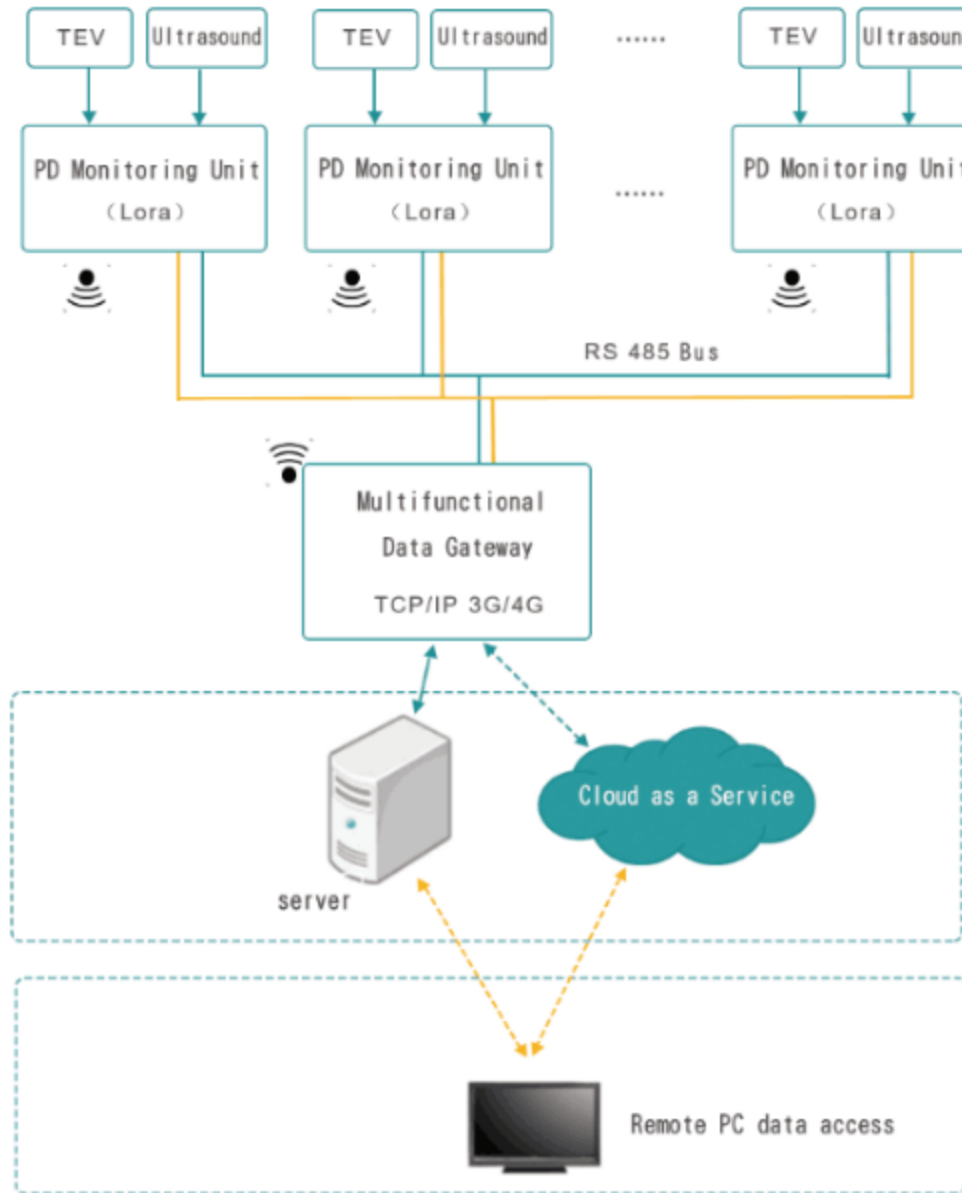
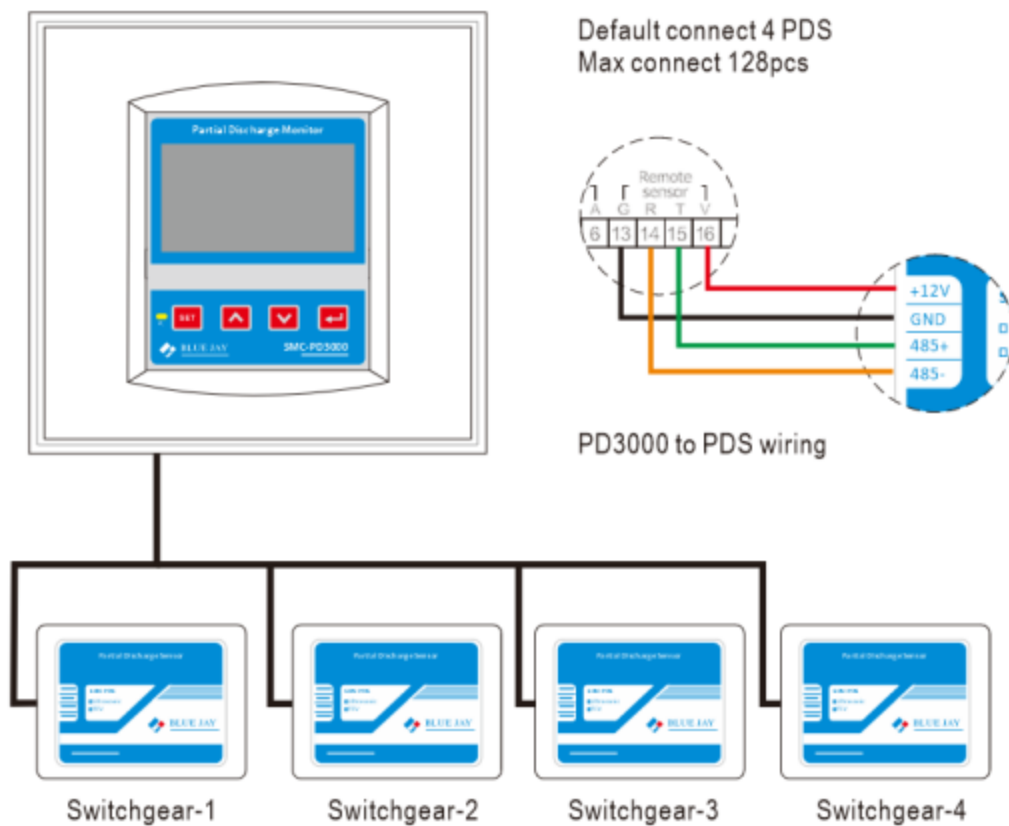

Figure 3. Overall structure of the system

3. - SENSOR INTRODUCTION

3.1. - External sensors (Ultrasonic and TEV)

There are two principles for partial discharge detection of switchgear: ultrasonic principle and transient earth voltage (TEV) principle. The external Ultrasonic sensor and TEV sensor of this product are used to measure partial discharge of high-voltage switchgear. Front position, this part needs to be close to (ultrasonic measurement) or close to (TEV measurement) high-voltage switchgear during testing. Note that approaching and closeness are different, depending on which principle is used to test the switchgear.



3.1.1. - Ultrasonic measurement

If you choose the external ultrasonic sensor to measure the partial discharge of the switchgear, you hardly need to do other operations or settings after starting up. Because the external ultrasonic sensor is selected by default after the product is turned on, the upper left of the screen will display which sensor is currently connected.

In the ultrasonic measurement mode, the measurement data is dBuV, because dBuV is a logarithmic function value based on 1uV, therefore, the measured data in the ultrasonic mode can be positive or negative. According to the processing capacity of the ultrasonic amplifier of this product, it can reach -6dBuV The test ranges to 68dBuV, the larger the negative value, the smaller the ultrasonic signal, the closer to 0dBuV, not negative! Usually the measured data in an interference-free environment is between -6dBuV and 0dBuV.

Insulation condition of switchgear:

Data	Definition
-6~0dBuV, no discharge sound	No partial discharge.
0 ~ 6dBuV, short discharge sound	Slight discharge, and attention should be paid to it later.
Above 6dBuV, have discharge sound	Obvious discharge, should be judged in combination with TEV.

Note:

The demarcation point (6dBuV) is slightly different in different regions, so it is recommended to use 6dBuV as the demarcation point, so that the operating status of the switchgear can be warned in advance.

3.1.2. - TEV measurement

In the TEV measurement mode, the reference pulse count value P/Cycle is also required, and the pulse number and amplitude comprehensively measure the health of the switchgear.

When the environmental value is large, it is necessary to find out the interference source. The interference source of TEV is different from that of ultrasonic. Ultrasonic interference is generally limited to a limited space, while TEV interference affects the entire space through radio frequency, such as electric welding machines, frequency converters, walkie-talkies, Wireless broadcasting stations, etc. Compared with ultrasonic interference, such interference signals are sometimes difficult to avoid or clear, so it is recommended to use ultrasonic measurement when the environment (interference) value is detected to be large.

Insulation condition of switchgear:

Data	Definition
The reading is <20dB.	No partial discharge, Recheck once a year.
The reading is 20-29dB.	Slight discharge.
The reading is 29-40dB.	Moderate partial discharge should report and shorten the inspection cycle.
The reading is 40-50dB.	Serious partial discharge should report and shorten the inspection cycle, and be checked when power failure.
The reading is 50-60dB.	Severe partial discharge, power outage and maintenance as soon as possible.

3.2. - Optional external sensors (AE, HFCT, UHF)

Name	Type	Definition
Contact ultrasonic sensor	AE measurement	For Transformers, GIS, Motors, Frequency: 40 ~ 150kHz.
High frequency transformer	HFCT measurement	For Cable, Frequency: 1 ~ 30MHz.
UHF sensor	UHF measurement	For GIS, Frequency: 300 ~ 2000MHz.

Note:

All the above sensors are connected through the sensor extension port at the bottom of the host. When the sensor is connected through the same extension port, the host will automatically identify the sensor type, select the sampling channel of the corresponding frequency, and display the relevant parameters of the sensor on the top of the interface.

4. - TECHNICAL SPECIFICATION

HMI electrical specification

Auxiliary power	85-265Vac/dc, 20-60Vdc Optional
Power consumption	<6W
Communication	RS-485, MODBUS-RTU
Digital output	2* NC & NO, passive node
Environment temperature	-10 ~ +60°C
Environment humidity	RH 20% ~ 95% (No condensation)
Dimensions (W × H × D)	96*96*85mm or 144*144*100mm
Open install hole	91*91mm or 138*138mm

Remote sensor common

Power supply	12Vdc or 2000mAh build in battery*
Wireless band	433MHz ~2.4GHz optional
Signal transmission distance	Up to 80m (260 feet)
Static power consumption	<10mW
Installation method	4* strong magnet, wall mount
Sampling period	4S

TEV sensor

Detect range	0~60 dBmV
Pass band	3~100MHz
Resolution / Accuracy	1dBmV / ±1dBmV

Ultrasonic sensor

Detect range	-7dBμV ~ 68dBμV
Resolution / Accuracy	1dBμV
Sensitivity	-65 dB (0 dB=1 volt/μbar rms SPL)
Sensor center frequency	40 KHz

UHF sensor (optional)

Detect range	-70~10dBm
Pass band	300~1500MHz
Average equivalent height	≥10mm
Noise detection range	30~130dB
Temperature detection range	-40~85°C
Humidity detection range	5~95%RH

5. - INSTALLATION AND START-UP

5.1. - Installation dimensions (unit: mm)

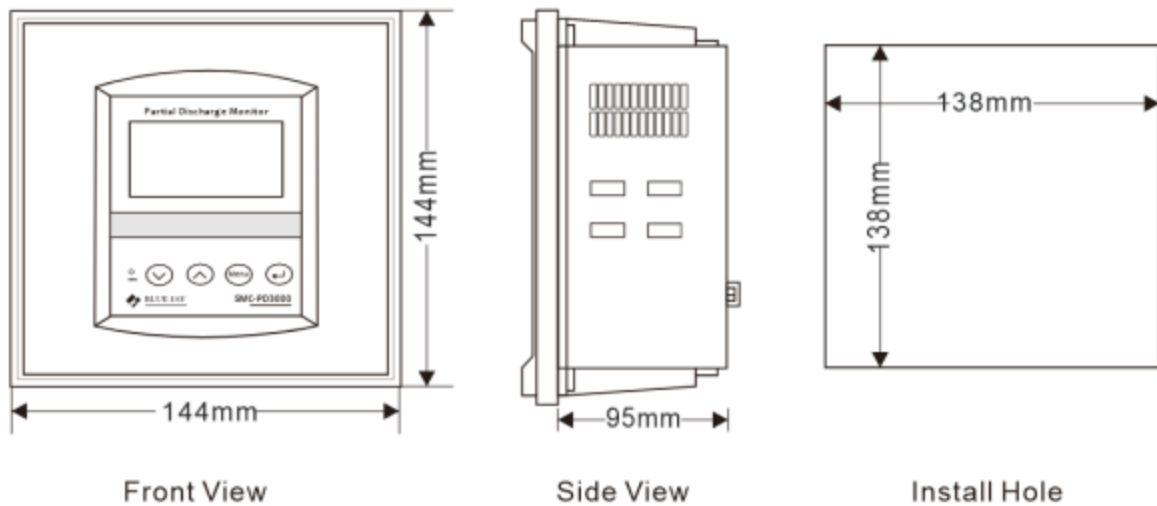

5.2. - Connection terminal (see label on the rear part)

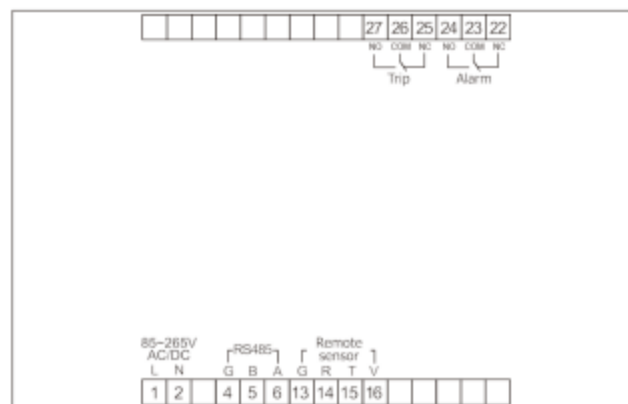

Upper connection terminal	Lower connection terminal
22 .(NC) Normal close pin	1. Supply voltage input:220 Va.c.
23 .(COM) Ground pin	2. Supply voltage input: 0 V
24 .(NO) Normal open pin	4. RS-485 (GND)
25, 26, 27 for Trip relay	5. RS-485 (-)
	6. RS-485 (+)
	13(G) 14(R) 15(T) 16(V):connect to data receiver unit corresponding pin

6. - SCREEN DISPLAY

6.1.- Panel diagram

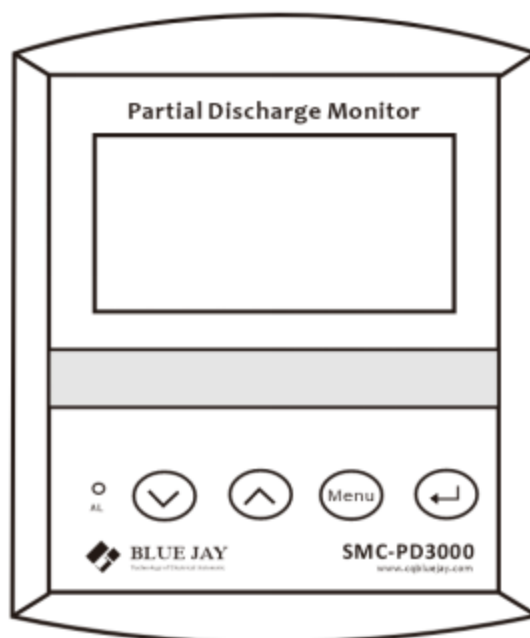







6.2.- Panel definition

No.	Display	Definition
1	3.3 inch matrix LCD	Show the measurement data, Can be customized to different languages.
2	Indicator of alarm output	Red LED show the alarm condition, alarm value can be programmable setting.
3*	Up and down key	Set the programming value.
4*	Menu key	Used to open the menu and return to previous menu.
5*	Enter key	For menu selection and confirmation.

Note:

Please see detail instructions of "*" items at ["OPERATION MODE"](#)

7. - OPERATION MODE

 	Up or down key to switch the display show.
 	At programming display mode, To increase or decrease the value.
	Open the programming menu And return to previous menu.
	Exit it with saving any modification, Or in menu operation to go to the next menu.

Notes:

1. If disconnection between the receiver module and the base unit, the display will show "**Broken**".
2. If abnormal caused by the temperature transmitter module fault, the display will show "**Error**".
3. If abnormal caused by a broken of thermocouple, the display will show "**V broken**".
4. If Transmitter battery have low-voltage, the display will show "**Under voltage**", in this case user should replace the batteries immediately.

8.- MENU INTRODUCTION

After the device is powered on, the present measurement status is displayed

No.01	A= 28.0°C	No.02	A= 00.0°C
AE=00DB	B=27.9°C	AE=00DB	B=00.0°C
TEV=10DB	C= 28.0°C	TEV=00DB	C= 00.0°C
09-05-21	05:16	09-05-21	05:16

The MENU in PD3000 is performed by several set options. Once into the MENU, use the key to select different options required variables:

→Configuration
SEO
HELP

Configuration: free to configuration system parameter.

SEO: Alarm events, can record last 10 lists info.

HELP: Help info (accept customized info).

8.1.- Setting

In this section, user can set:

1. Time setting
2. Alarm setting
3. COMM setting
4. Note setting

8.1.1.- Setting the local time



In setting mode, press key  the monitor will show:

→Time setting
Alarm setting
COMM setting
Note setting

Then press  again, the monitor will show:

2009-05-21
05:17

[OK]

Use key  and  to set the value, after set, press  to save and exit the local time setting.

8.1.2.- Setting the alarm trig value

The base monitor unit have two relays output for alarm, the connect pin for relay please refer to [Chart 5.2](#).

Time setting →Alarm setting COMM setting Note setting	In setting menu, choose this item, and press  to enter the alarm setting.
--	--

Then press  again, the monitor will show:

Monitor can set two alarm output values:

Temp Alarm: 40°C AE TEV Al.: 60dB Alarm HYS: 05 [OK]	Alarm threshold temperature: for notes onsite person the temperature change. Trip threshold temperature: can connect breaker or other Actuator to forced shutdown circuit, prevent over-temperature damage.
--	--

Note:

Trigger threshold value should be higher than alarm threshold value

After set, press  to save and escape the local time setting

8.1.3.- Setting the Communication value

Time setting
Alarm setting
→COMM setting
Note setting

Base monitor unit can be connected to a P.C. With this system we can get all the parameters in one central point of reading.

If we connect more than one device to the same communication line (RS-485), we have to assign to each of them a different code or direction (from 1 to 247), since the P.C. needs the identification of every measuring point.

Then press  again, the monitor will show:

COMM ADDR: 01
Baud Ratio: 9600

[OK]

Communication address: the set value from 1~247

Baud ratio: the set value from 4800~19200

8.1.4.- Setting the node value

Time setting
Alarm setting
COMM setting
→Note setting

PD3000 Allows customers to define the name of each probe point.
(Default is disabled, accept customized info)

Then press  again, the monitor will show:

Group Num: 06

[OK]

8.2.- Alarm event review

The base monitor unit can record the alarm event, user can easily view the over-temperature conditions on the unit, without other device

In the setting menu, press  and  to choose alarm event, the screen will show:

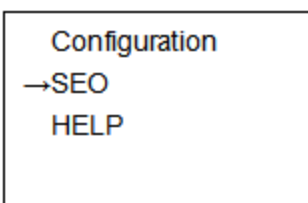

In this screen, it will display record alarm events, it can record last 10 lists info.

Press  the screen show:

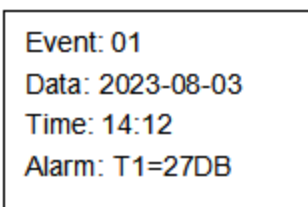

If the monitor detects over-temperature, it will record the alarm type, data, time, and temperature, the memory standard is 10 items, need more record capacity, please contact Blue Jay Electronic sales team.

8.3.- Help information

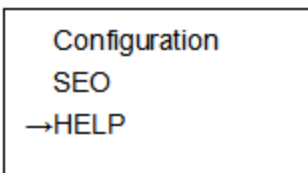

This screen displays product model and version information

Press  the screen show:

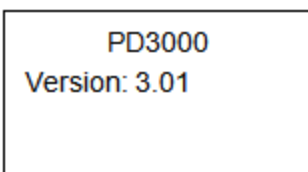

The device version number is: 3.01

9.- COMMUNICATION INTERFACE

This document defines the communication protocol specification, please strictly follow this communication protocol to connect with the device.

9.1.- MODBUS © protocol

Modbus RTU Frame Format:

Address code	1 BYTE	<i>Slave device address 1-247</i>
Function code	1 BYTE	<i>Indicates the function codes like read coils / inputs</i>
Data code	4 BYTE	<i>Starting address, high byte Starting address, low byte Number of registers, high byte Number of registers, low byte</i>
Error Check code	2 BYTE	<i>Cyclical Redundancy Check (CRC)</i>

MODBUS FUNCTIONS

Code	Meaning	Description
FUNCTION 03	Read holding register	<i>Read device setting data</i>
FUNCTION 04	Read input register	<i>Read device measurement data</i>
FUNCTION 06	Write Single Register	<i>Writes a value into a single holding register.</i>
FUNCTION 10	Write Multiple Register	<i>Writes values into a sequence of holding registers</i>

Note:

Starting address:0X0000, the first byte is the high bit, and the second byte is the low bit.

9.2.- Register Map

Register	Data (Read only)	Byte	Value range
0000	Channel 1 wireless temperature measurement value	2	-40 ~ 150°C
0001	Channel 2 wireless temperature measurement value	2	-40 ~ 150°C
0002	Channel 3 wireless temperature measurement value	2	-40 ~ 150°C
0003	Channel 4 wireless temperature measurement value	2	-40 ~ 150°C
0004	Channel 5 wireless temperature measurement value	2	-40 ~ 150°C
0005	Channel 6 wireless temperature measurement value	2	-40 ~ 150°C
0006	Channel 7 wireless temperature measurement value	2	-40 ~ 150°C
0007	Channel 8 wireless temperature measurement value	2	-40 ~ 150°C
0008	Channel 9 wireless temperature measurement value	2	-40 ~ 150°C
.....		2	
0059	Channel 60 wireless temperature measurement value	2	-40 ~ 150°C
0060	Channel 1 AE discharge peak value	2	0 ~ 100DB
0061	Channel 2 AE discharge peak value	2	0 ~ 100DB
.....		2	
0119	Channel 60 AE discharge peak value	2	0 ~ 100DB
0120	Channel 1 TEV discharge peak value	2	0 ~ 100DB
0121	Channel 2 TEV discharge peak value	2	0 ~ 100DB
.....			
0179	Channel 60 TEV discharge peak value	2	0 ~ 100DB

Notes:

- RS485 communication interface, asynchronous half-duplex mode;
- Communication speed, baud rate: 9600bps (default, baud rate can be set);
- Byte transmission format: 1 start bit, 8 data bits, 1 stop bit, (n,8,1 e,8,1 o,8,1) optional.

10.- SAFETY CONSIDERATIONS



All installation specification described at the previous chapters named:
INSTALLATION AND STARTUP, INSTALLATION MODES and SPECIFICATIONS.

Please note that with the instrument powered on, the terminals could be dangerous to touching and cover opening actions or elements removal may allow accessing dangerous parts. This instrument is factory-shipped at proper operation condition.

- ◆ The device must have a professional installation and maintenance.
- ◆ Any operation of the device, you must cut off the input signal and power.

11.- TECHNICAL SERVICE

For any inquiry about the instrument performance or whether any failure happens, contact to Blue Jay's technical service.

Blue Jay - After-sales service

*1802, Building 2, No.88, Jianxin East Road,
Chongqing,400020, China*

*Tel - + 0086 023 67628702
E-mail: tech@cqbluejay.com*