

BJ-PR200 series

Electronic Motor Protection Relay

User Manual

Version 1.6

Revision 2022-8

Read me

When you use BJ-PR200 series electronic motor protection relay, be sure to read this user manual carefully, and be able to fully understand the implications, the correct guidance of operations in accordance with user manual, which will help you make better use of BJ-PR200 series motor protector, and help to solve the various problems at the scene.

1. Before the meter turning on the power supply, be sure that the power supply within the provisions of the instrument;
2. When installation, the current input terminal must non-open, voltage input terminals must Non-short circuit;
3. Communication terminal (RS232/RS485 or Ethernet) is strictly prohibited to impose on high pressure;
4. Be sure the instrument wiring consistent with the internal system settings;
5. When communicating with the PC, instrument communication parameters must be consistent with the PC.



- **Please read this user manual carefully**
- **Please save this document**

Directory

1. - SUMMARIZE.....	- 4 -
2. - FEATURES	- 4 -
3. - SPECIFICATIONS	- 5 -
4.- INSTALLATION AND START-UP	- 7 -
4.1.- INSTALLATION	- 7 -
4.2.- TYPICAL WIRING	- 8 -
5. OPERATION MODE.....	- 9 -
5.1- PANEL KEY OPERATION.....	- 9 -
5.2- MOTOR PROTECTOR START	- 10 -
5.3- REAL-TIME FAULT DETECTION	- 10 -
5.4- SEQUENCE OF EVENT (SOE)	- 10 -
5.5- CONFIGURATION MENU STRUCTURE INTRODUCTION	- 11 -
5.6- EXAMPLE OF PROGRAMMING MENU OPERATION	- 12 -
5.6.1- <i>Set sampling input value</i>	- 12 -
5.6.2- <i>Overload protection setting</i>	- 13 -
6. - RS485 COMMUNICATION PORTOCOL.....	- 14 -
6.1.- MODBUS © PROTOCOL	- 14 -
6.1.1- <i>Modbus RTU Frame Format:</i>	- 14 -
6.1.2.- <i>Modbus function code</i>	- 15 -
6.2.- REGISTER MAP-I (ONLY READ, USE CODE 04)	- 16 -
6.3.- REGISTER MAP (II.- READ AND WRITE PARTS).....	- 17 -
7.- PORTECTION FUNCTION INTRODUCTION	- 19 -
7.1- START OVERTIME PROTECTION.....	- 19 -
7.2- OVERLOAD PROTECTION	- 20 -
7.3- PHASE FAILURE PROTECTION.....	- 22 -
7.4- STALL PROTECTION.....	- 22 -
7.5- CURRENT IMBALANCE PROTECTION.....	- 22 -
7.6- UNDER LOAD PROTECTION	- 23 -
7.7- ROTOR JAM PROTECTION	- 23 -
7.8- GROUND FAULT PROTECTION(OPTIONAL)	- 23 -
7.9.- TE PROTECTION	- 24 -
8- I/O OUTPUT (OPTIONAL).....	- 25 -
8.1.- ANALOG OUTPUT PORT	- 25 -
8.2.- DIGITAL OUTPUT PORT	- 25 -
8. - SAFETY CONSIDERATIONS.....	- 26 -
9. - MAINTENANCE.....	- 26 -

1. - SUMMARIZE

PR200 motor protection relay is an all-in-one solution designed to continuously monitor 3-phase power lines for abnormal conditions. It can use with motors less than 690V/820A. Packed inside a small and economic package you'll find a solution designed to save you time and money.

The series of products through the real-time monitoring of the scene signal, provide various protection trip to avoid motor failure. When the PR200 sense the motor operating parameters to achieve the preset alarm value, will trig the DO port to warning the abnormal status; abnormal parameters continue to accumulate to a dangerous value, will automatically trigger the release switch to shut down the circuit.

Option RS485 communication port can upload the monitor data and alarm status to remote control system.

Protection function (Details please refer to chapter 7)

Start Overtime,
Over Load,
Phase Failure,
Stall,
Current imbalance,
Under load,
Jam,
Ground fault

2. - FEATURES

- High accuracy sample calculation, class 0.5 for 2% -120% measurement range; class 1 for 120% -1000% measurement range.
- Built-in 2-channel relay, free to user set protected trip mode, alarm mode and trig mode.
In protection mode, channel 1 relay can use for alarm, channel 2 for trig operation.
- User free to set each protection function act off, alarm or trip.
- Build in Sequence of Event function, can logger last 10 trip records.
- With programmable analog output function, user option RS-485 communication interface.
- Can provide basic electrical parameter for user SCADA system.
- Wide range of power supply AC85-265V or AC80-450V.

3. - SPECIFICATIONS

Working environment:

Motor rated voltage:	AC380V / AC660V
Motor rated current:	0.5-820A
Working temperature:	-20C ~ +60C
Storage temperature:	-40C ~ +80C
Relative humidity:	< 93% RH
Elevation:	not more than 3000 m
Atmospheric conditions:	installation site does not allow the explosive medium, containing gas to corrode metal and damage the insulation and conductive medium.

Measuring accuracy:

Current:	$\pm 0.5\%$ (2% to 120% of I_e) $\pm 1\%$ (120% to 10% of I_e)
Voltage:	$\pm 0.5\%$
Leakage current:	$\pm 1\%$ (10% to 100% of I_r)
Analog Output:	$\pm 1\%$ (4 ~ 20mA)

Electrical parameters:

Auxiliary Power:	AC80-450V (DC110V-500V)
Power consumption:	<4 VA
Insulation resistance:	> 100M Ω
Relay:	Trip relay @ 10A / AC250V, 10A / 30VDC (NC node) Alarm relay @ 5A / 250VAC, 5A / 30VDC (NO node)

Electrical test:

IEC 61000-4-2	level III
IEC 61000-4-4	level III
IEC 61000-4-5	level III
IEC 61010-1	AC2kV/1min Between power / input / output

Product standards

GB / T 14048.1 (IEC 60947-1)	Low-voltage switchgear and control equipment General Provisions
GB / T 14048.4 (IEC 60947-4)	Low voltage electromechanical contactors and motor starters requirements
JB / T 10613-2006	General specification for digital motor combined protection equipment
JB / T 10736-2007	Low voltage motor protection

Protection CT selection guide

PR200 ampere range (I.scl)	Motor rated ampere (Ie)	Description
2A	0.5-2A	Protection CT provide by PR200 body CT ratio set to 1
5A	1-5A	
25A	5-25A	
100A	25-100A	
200A	100-200A	
250/5	150-250A	Connect extra protection CT ..5A CT ratio use 50 / 100 / 160 Notes: If motor rated ampere over 200A, need external protect CT, protect grade 5P10, accuracy 0.5 class, 1* PR200 need 3pcs CT
500/5	250-500A	
800/5	500-800A	

Residual current CT

If PR200 choose ground fault protection, need external LCT05/30 series CT for detect leakage current.

LCT05 rated current of 500mA, the current range (50 ~ 500mA)

LCT30 rated current of 30A, the current range of (3 ~ 30A)

Each PR200 need 1pcs, please contact sales team for purchase issue.

4.- INSTALLATION AND START-UP



The manual you hold in your hand contains information and warnings that the user should respect in order to guarantee a proper operation of all the instrument functions and keep it in safety conditions. The instrument must not be powered on and used until its definitive assembly is on the cabinet's door.

If the instrument is not used as manufacturer's specifications, the protection of the instrument will be damaged.

When any protection failure is suspected to exist (for example, it presents external visible damages), the instrument must be immediately powered off. In this case contact a qualified service representative.

4.1.- Installation

Mounting

PR200 series motor protector have two version installation mode, one for CT separate installation, another is CT integrated installation. Each instrument is to be mounted on panel (cut-out a mounting hole). Keep all connections into the cabinet.

Note that with the instrument powered on, the terminals could be dangerous to touch and cover opening actions or elements removal may allow accessing dangerous parts. Therefore, the instrument must not be used until this is completely installed.

Note: This connection drawing is for reference only; the actual connecting terminal please refer to the label on the rear part.

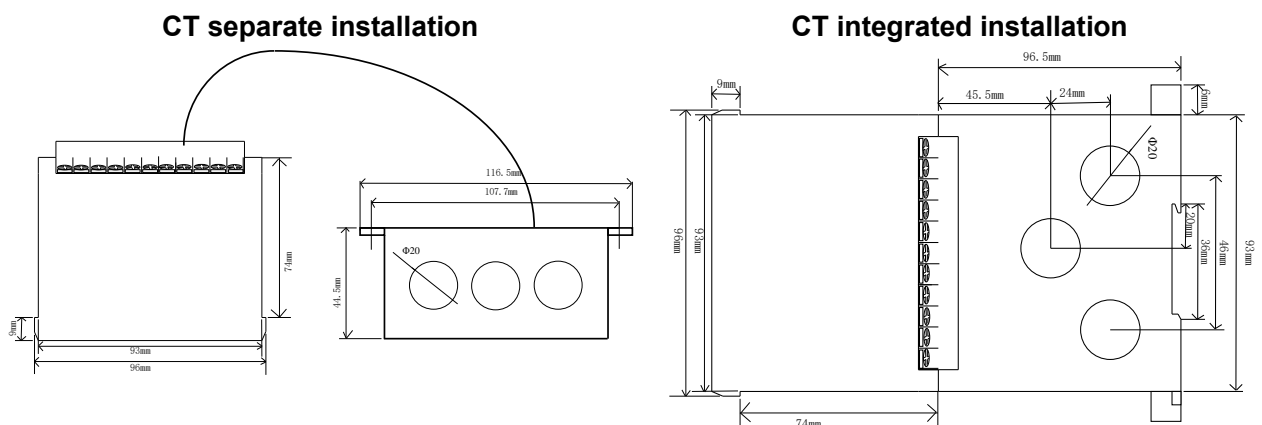

4.2.- Typical Wiring

4.2.1.- Connection with residual protection CT

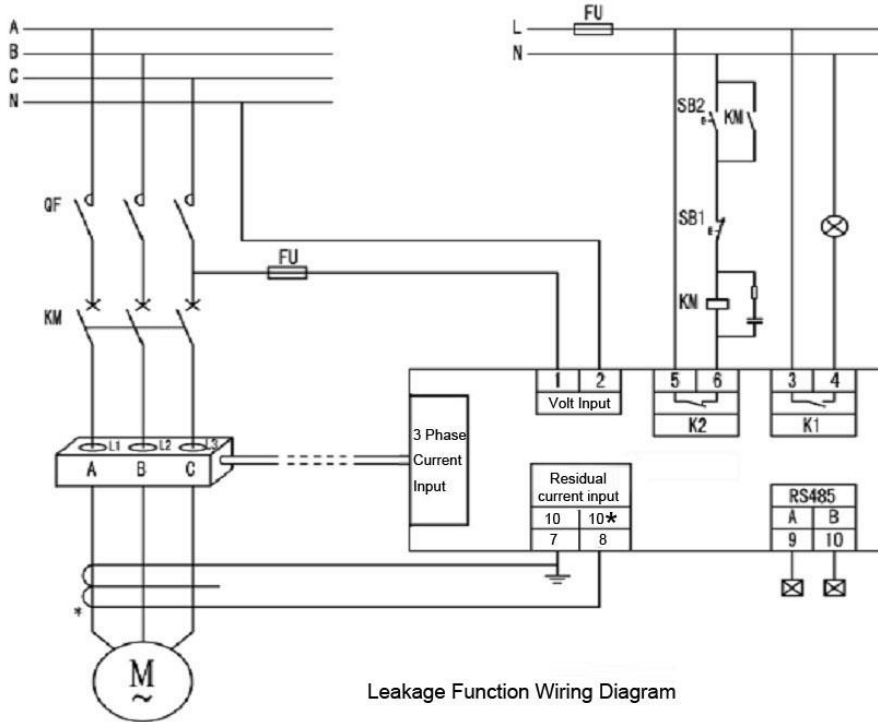

4.2.2.- Connection with analog output

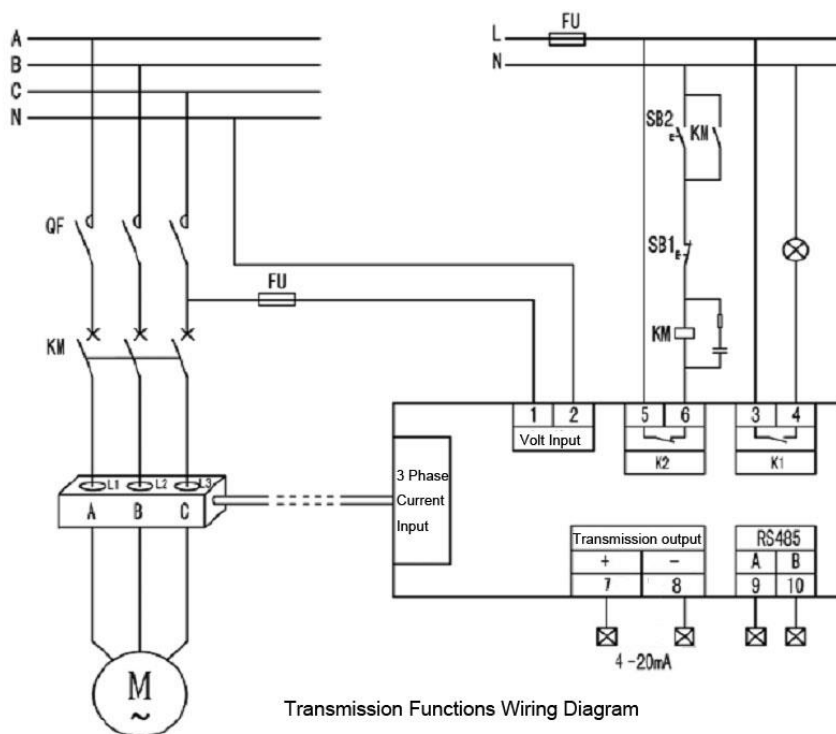



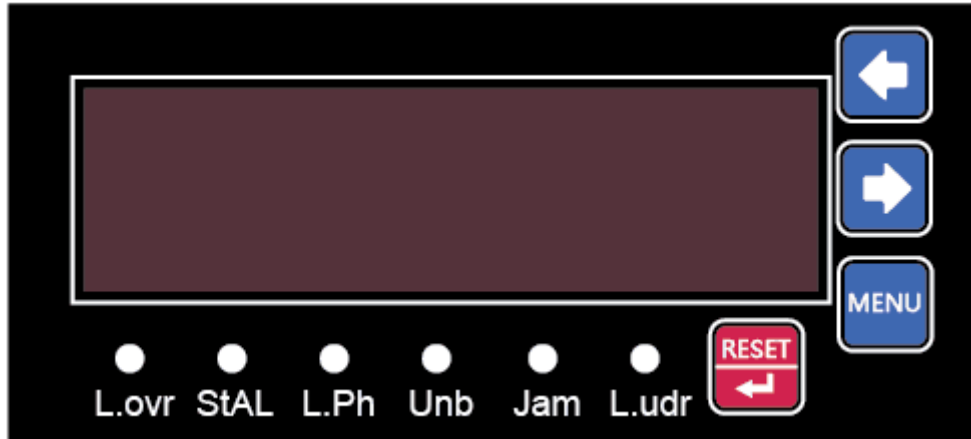

5. OPERATION MODE







5.1- Panel key operation



5.1.1- Key operation

		In Monitor screen for move to next / previous page In configuration menu for value increase/decrease
		Configuration menu enters or exit & roll back to up layer menu
		Enter next layer menu or confirm the change



5.1.2- Enter configuration menu



In normal monitor status, press key , the main screen will show “CodE”, press key  into password screen, use key  and  to enter password (default user password is 0001), then press key  to confirm enter, in password correct can into the menu screen, or still ask password.

5.1.3- Exit configuration menu

After parameter set, press key , protector screen show “SAVE”, then press key  for save the change and exit, press key  for exit without save.

5.2- Motor protector start

When the PR200 is powered up, the screen show “StOP”, mean the motor without work, user can press key  and  to check basic electrical parameter.

In the motor start period will show “- - -”, after the start successful, the protector in normal working status, will automatic show three phase electrical parameter in turn. Then press  key can choose page rolling manually or page rolling automatically, use key  or  for manually switch to next or previous display page.

5.3- Real-time fault detection

When a motor failure is detected, PR200 will act different logic:

Act for alarm

- Indicator lights in the front panel will **ON**;
- Alarm relay be trigged

After the failure be removed:

- Indicator will automatically turn off;
- Alarm relay automatic reset to NO status

Act for trip



- Indicator lights in the front panel will **flicker**
- Alarm relay be trigged
- Trip replay be trigged

After the failure be removed:

- Must press  key to reset protector to normal status;

Notes: If overload protection trip, must waiting enough time for cool down then can success release.

5.4- Sequence of Event (SOE)

Press key  and  to hold can entry SOE screen to view alarm and failure log information. Pr200 will show the latest 10 SOE, in number of "SOE0" to "SOE9", "SOE0" is the latest records. If no record the screen show “noP”

SOE NO. in RS485 communication	Failure code	Failure type
0	noP	No record
1	SLnG	Start over time
2	Lour	Over load
3	L. Ph	Phase failure
4	JAn	Jam
5	Unb	Current imbalance
6	Ludr	Under load
7	StAL	Stall
8	l o	Ground fault
9	TE	tE time
10	Uour	Over voltage
11	Uudr	Under voltage

5.5- Configuration menu structure introduction

Level 1	Level 2	Level 3 (Value range)
Signal input SLnG	CT range	SLnG 1A, 2A, 5A, 10A, 25A, 50A, 100A, 200A
	CT ratio	r.Ct 1-9999
	Residual current measurement mode	SLnG In / out
	Residual CT measurement range	.E.P.L 300~30000mA
Motor parameter SLnG	Motor rated voltage	SLnG 220V/380V
	Motor rated current	SLnG 0.5~200A
Protection function setting Prot	Start over time protection	SLnG OFF / ALM / TriP
	Motor start timer	L.Our 1.0~600.0s
	Overload protection	L.Our OFF / ALM / TriP
	Overload K-factor	L.Ph 10~1200
	Overload Cool down timer	L.Pn 1-1200min
	Overload reset mode	..Pt Auto / MAn
	Phase failure protection	L.Ph OFF / ALM / TriP
	Phase failure trip delay	JAn 0~50.0s
	Jam protection	JAn OFF / ALM / TriP
	Jam protection threshold	L.udr 100~1000%Ie
	Jam protection trip delay	L.udr 0.5~50.0s
	Current imbalance protection	Unb OFF / ALM / TriP
	Current imbalance protection threshold	Unbu 5~60%
	Current imbalance trip delay	Unbt 0~50.0s
	Under load protection	L.udr OFF / ALM / TriP
	Under load protection threshold	StAL 20~100%Ie
	Under load protection trip delay	StAL 0.5~50.0s
	Stall protection	StAL OFF / ALM / TriP
	Stall protection threshold	ln 100~800%Ie
	Stall protection trip delay	ln 0.5~50.0s
Ground fault protection	lg OFF / ALM / TriP	
Ground fault residual current threshold	lgur 10~100%IΔn	
Ground fault protection trip delay	lgur 0.1~50.0s	
Analog output RoUt	Overvoltage protection	Uour OFF / ALM / TriP
	Overvoltage protection threshold	Uu 105~150%Ue
	Overvoltage protection trip delay	Uu 0.1~50.0s
	Under voltage protection	Uudr OFF / ALM / TriP
	Under voltage protection threshold	Uudu 45~95%Ue
	Under voltage protection trip delay	Uudt 0.1~50.0s
Digital output do-1,do-2	Analog out put	I t Eñ Ia, Ib, Ic, Iavg
	Analog output ratio	rAnG 1~10
Communication Coññ	DO function	rñ 0~10
	Protector address	Addr 1~247
	Communication baud	bAUd 1200bps, 2400bps, 4800bps, 9600bps
	Data format	dAtA n.8.1, o.8.1, e.8.1, n.8.2
Password setting SYS	New password	Ecod Default 0001
Software version		UEr
Screen mode	Data shown mode	dñod 0: display in actual value; 1: Display in percentage.

Note: Not all PR200 series have above complete configuration menus, please confirm your purchased PR200 sub-code, if do not have the corresponding extension module. In configuration menu corresponding part is invalid.

5.6- Example of programming menu operation

5.6.1- Set sampling input value

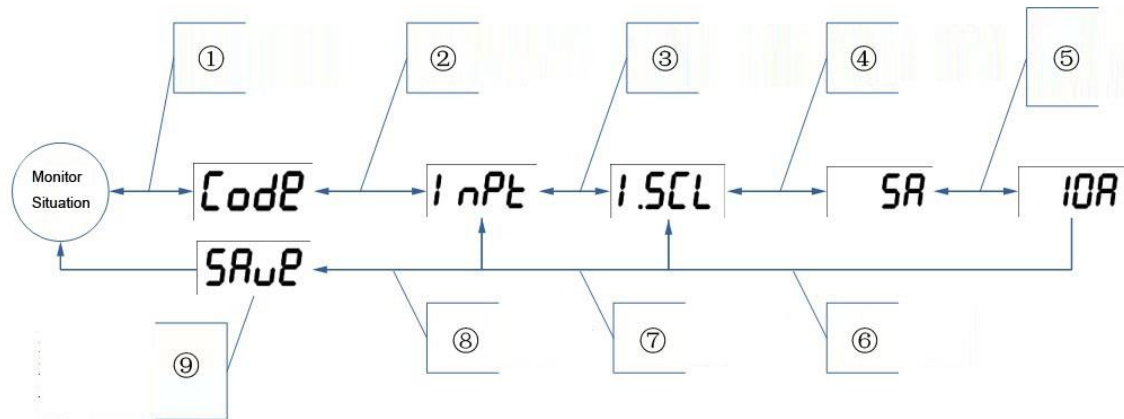

Step1: Press **Menu** enter configuration menu; device ask password;

Step2: Press **Enter** for entry password, use key **Left** & **Right** to input password **0012**, will move to Level-1 configuration menu;

Step3: Press **Enter** to enter level-2 of **"Signal Input"** menu, to set Input current range **"InPt"**;

Step4: Press **Enter** enter level-3 value range selecting, you can see default current range **"5A"**;

Step5: Press **Left** or **Right** to select input current range, in example use **"10A"**;

Step6: Press **Enter** to confirm the modify and return to the previous level menu;

Step7: Press **Menu** for roll back to the level-1 menu;

Step8: Press **Menu** for exit configuration to the monitor screen;

Step9: Main screen show **"SAVE"**, press **Enter** for save the change and exit configuration;

press **Menu** for exit without save.

5.6.2- Overload protection setting

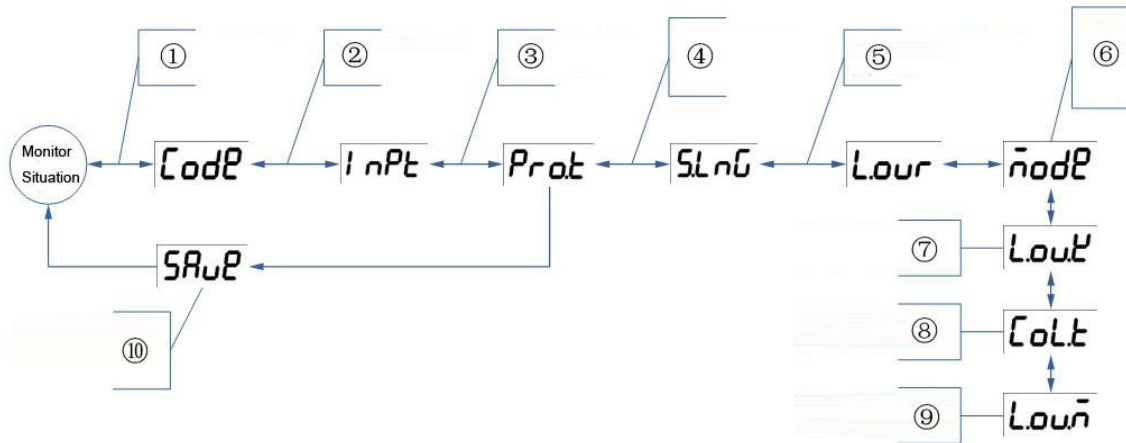

Step1: Press **Menu** enter configuration menu; device ask password;

Step2: Press **↵** for entry password, use key **←** & **→** to input password **0001**, will move to Level-1 configuration menu;

Step3: Press **←** or **→** to choose **Protection function setting** menu "**Pro.t**";

Step4: Press **↵** to enter level-2 of "**Pro.t**", you can see **Start timeout set** menu "**S.LnG**";

Step5: Press **←** or **→** to choose **Overload protection** submenu "**L.our**";

Step6: Press **↵** to entry level-3, device ask set **Protection mode** menu "**ModE**",

Then press **↵** again entry selection, Press **←** or **→** to choose "**ALRM**", "**TRIP**", "**OFF**";

After select, press **↵** to confirm the modify return to the previous level menu

Step7: In protection mode level-2, press **→** can set the overload K-factor;

Step8: In protection mode level-2, press **→** can set the overload cool down time;

Step9: In protection mode level-2, press **→** can set the overload reset mode;

Step10: Press **Menu** for exit configuration to the monitor screen;

Main screen show "**SAVE**", press **↵** for save the change and exit configuration;

press **Menu** for exit without save.

6. - RS485 COMMUNICATION PORTOCOL

6.1.- MODBUS © protocol

The composition of the RS-485 cabling must be carried out with a meshed screen cable (minimum 3 wire), diameter of not less than 0.5mm², with a maximum distance of 1,200 m between the motor protector and the master unit. This Bus may connect a maximum of 32unit.

Notes:

1. For communication with the master unit, customers can choose the RS-232 to RS-485 converter to use.
2. Not all the PR200 with RS485 port, please check your ordered product to confirm if the meter has remote communication function.

Due to product modifications or custom requirements, the interface pin place may be change. For details, please refer to product label on the rear board

6.1.1- Modbus RTU Frame Format:

Address code	1 BYTE	<i>Slave device address 1-247</i>
Function code	1 BYTE	<i>Indicates the function codes like read coils / inputs</i>
Data code	4 BYTE	<i>Starting address, high byte Starting address, low byte Number of registers, high byte Number of registers, low byte</i>
Error Check code	2 BYTE	<i>Cyclical Redundancy Check (CRC)</i>

6.1.2.- Modbus function code

Code:	Meaning:	Description:
FUNCTION 01	Read multiple Coils	<i>This function permits to read Internal Bits or Physical Coils</i>
FUNCTION 02	Read signal Coils	<i>This function permits to read Physical Discrete Inputs</i>
FUNCTION 03	Reading of n Words of holding register	<i>Read protection setting, system parameters, starting parameters, etc. Read the I/O port status</i>
FUNCTION 04	Reading of n Words of input register	<i>Read measurement values (voltage, current, power, etc.); Read SOE record</i>
FUNCTION 05	Force Single Coil	<i>This function permits to write Internal Bits or Physical Coils</i>
FUNCTION 06	Write single register	<i>This function permits to write</i>
FUNCTION 15	Write Multiple Coils	<i>This function permits to write Internal Bits or Physical Coils</i>

Example: (Read A, B, C phase current value)

Host to Slave

Addr	Fun	Data Address (high)	Data Address (low)	Data Number (high)	Data number (low)	CRC16 (low)	CRC16 (high)
01H	04H	01H	00H	00H	03H	BEH	F7H

Slave to Host

Addr	Fun	Data length	A-phase current		B-phase current		C-phase current		CRC	
01	04	06	03	E8	03	E8	03	E7	C0	7D

Note: Not all the PR200 series have RS485 full operation function, please refer the register map introduction.

6.2.- Register Map-I (Only Read, use code 04)

Type	Address (Hex)	Parameter	Unit
Parameter	0x00	A-phase Current	0.1A
	0x01	B-phase Current	0.1A
	0x02	C-phase Current	0.1A
	0x03	RMS Voltage	0.1V
	0x04	Frequency	0.00Hz
	0x05	Residual current	%IΔn
	0x06	Current average	0.1A
	0x07	A-Phase current percentage	
	0x08	B-Phase current percentage	
	0x09	C-Phase current percentage	
	0x0A	Voltage percentage	
	0x0B	residual current percentage	
	0x0C	Current average percentage	
	0x0D	A-phase current imbalance	
	0x0E	B-phase current imbalance	
	0x0F	C-phase current imbalance	
	0x10~0x31	reversed	/
	0x32	Voltage rating	
	0x33	Current rating (External CT)	
	0x34	CT ratio	
0x35	Motor rated ampere (Ie)		
0x36	Residual current settings		
0x37	Relay output status		
SOE1	0x100	Failure type	
	0x101	SEO NO.	
.....
SOE 10	0x112	Failure type	
	0x113	SEO NO.	

6.3.- Register map (II.- Read and write parts)

Cautions!

1. This chapter register map in default products the write function is disable in standard PR200, that to avoid unexpected damage due to frequent write operations, only opened for customer requirement!!
2. Registers support maximum 100,000 times writes, wrong write registers may cause device irreparable damage! Please ensure that host software engineer proficient in RS485 MODBUS protocol.
3. When the customer request valid the register write function, Blue Jay Technology Co., Ltd. will not responsible for any damage caused by the register write operation!!

Address	Description		Note
0x200H	reversed		
...	reversed		
0x20FH	reversed		
0x210H	Pass word		Input range: 0000-9999
0x211H	Current measurement range (default 5A)		Optional: 0: 1A 4: 25A 1: 2A 5: 50A 2: 5A 6: 100A 3: 10A 7: 200A
0x212H	CT ratio		Range: 1-9999
0x213H	Residual current range		Range: 0.1A-10A
0x214H	Voltage measurement range (default 380V)		Optional: 0: 220V 1: 380V
0x215H	Motor rated current		Range: 0.5 ~ 200A
0x216H	MODBUS address		Range: 1~127
0x217H	Baud ratio		0: 2400 1: 4800 2: 9600 3: 19200
0x218H	Data format		0: n.8.1 1: o.8.1 2: e.8.1 3: n.8.2
.....			
0x300H	Motor starting timer	Start over time protection	Range: 1.0 ~ 600.0s
0x301H	Overload K-factor	Over load protection	Range: 0-12 for K (10 ~ 1200)
0x302H	Overload Cool down timer		Range: 1-1200min
0x303H	reversed	/	/
0x304H	Phase failure trip delay	Phase failure protection	Range: 0 ~ 50.0sec
0x305H	Jam threshold	Jam protection	Range: 100 ~ 1000% Ie
0x306H	Jam trip delay		Range: 0.5 ~ 50.0sec
0x307H	reversed	/	/
0x308H	Current imbalance threshold	Current imbalance protection	Range: 5 ~ 60%

0x309H	Current imbalance trip delay		Range: 0 ~ 50.0sec
0x30AH	Under load threshold	Under load protection	Range: 20 ~ 100%Ie
0x30BH	Under load trip delay		Range: 0.5 ~ 50.0sec
0x30CH	Stall threshold	Stall protection	Range: 100 ~ 800%Ie
0x30DH	Stall trip delay		Range: 0.5 ~ 50.0sec
0x30EH	Residual current threshold	Ground fault protection	Range: 10 ~ 100%IΔn
0x30FH	Ground fault trip delay		Range: 0.1 ~ 50.0sec
0x310H	Overvoltage threshold	Overvoltage protection	Range: 105 ~ 150%Ue
0x311H	Overvoltage trip delay		Range: 0.1 ~ 50.0sec
0x312H	Under voltage threshold	Under voltage protection	Range: 45 ~ 95%Ue
0x313H	Under voltage trip delay		Range: 0.1 ~ 50.0sec
0x314H	tE setting		Range: 1 ~ 15
0x315H	Protection function status	0: disable 1: enable	BIT0: Start over time BIT1: Over load BIT2: Phase failure BIT3: Jam BIT4: Current imbalance BIT5: Under load BIT6: Stall BIT7: Ground fault BIT8: tE BIT9: Over voltage BIT10: Under voltage
			BIT14: Overload reset mode 0: manual 1: automatic
0x316H	Protection function mode	0 for Alarm; 1 for Trip	BIT0: Start over time BIT1: Over load BIT2: Phase failure BIT3: Jam BIT4: Current imbalance BIT5: Under load BIT6: Stall BIT7: Ground fault BIT8: tE BIT9: Over voltage BIT10: Under voltage
0x800H	Empty SOE records		Input command: 0A0A

7.- PORTECTION FUNCTION INTRODUCTION

7.1- Start Overtime protection

After the starting timer, if the three-phase average current ≥ 1.1 times the motor rated current (I_e) or $\leq 10\%$ of the motor rated current (I_e) or three-phase average current, start timeout protection action.

Protection mode	Alarm / Trip
Start timer	1.0 ~ 300.0s
Trip delay	0

7.2- Overload protection

Protector can track thermal capacity of the motor to avoid motor from overheating or damage. Controllers to simulate the thermal capacity of the motor in a variety of operating conditions, can real-time monitoring of motor heating conditions. Ensure effective protection of the repeated starting of the motor overheating condition continuous run.

Device provide 12 inverse time protection curves; user can select suitable curve for different motor working condition.

Typical trip time in different K factor and protection class

K factor	Class	I/Ie	1.0	1.2	1.5	7.2
125	10	Tripping time	Without trip in 2h	trip in 1h	≤2min	2s<Tp≤10s
250, 300	10				≤4min	4s<Tp≤10s
500	20				≤8min	6s<Tp≤20s
750	30				≤12min	9s<Tp≤30s

Inverse-time formula:

$$t = \frac{K}{\left(\frac{I}{I_e}\right)^2 - 1}$$

t -- Operating inverse time

I-- Actual motor working current value

Ie -- Motor rated current

K – Preset K factor curve need set

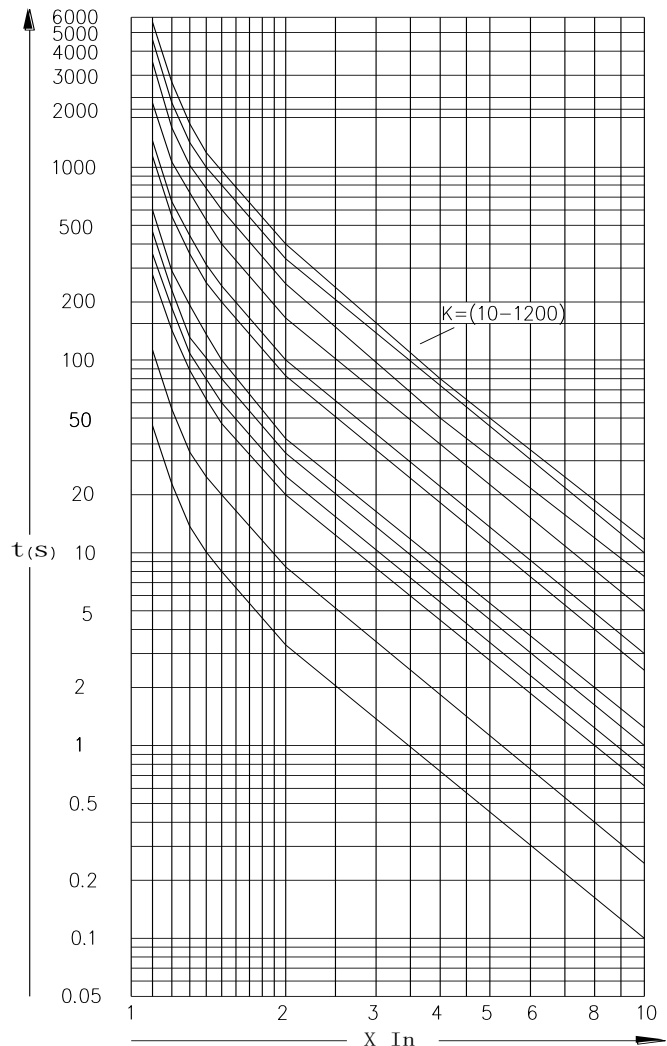

Overload inverse time curve quick select chart (t unit: sec)

$\frac{K}{I/e}$	10	25	60	75	100	125	250	300	500	750	1000	1200
1.1	47.62	119.05	285.71	357.14	476.19	595.24	1190.48	1428.57	2380.95	3571.43	4761.90	5714.28
1.2	22.73	56.82	136.36	170.45	227.27	284.09	568.18	681.82	1136.36	1704.55	2272.73	2727.27
1.3	14.49	36.23	86.96	108.70	144.93	181.16	362.32	434.78	724.64	1086.96	1449.28	1739.13
1.4	10.42	26.04	62.50	78.13	104.17	130.21	260.42	312.50	520.83	781.25	1041.67	1250.00
1.5	8.00	20.00	48.00	60.00	80.00	100.00	200.00	240.00	400.00	600.00	800.00	960.00
2.0	3.33	8.33	20.00	25.00	33.33	41.67	83.33	100.00	166.67	250.00	333.33	400.00
2.5	1.90	4.76	11.43	14.29	19.05	23.81	47.62	57.14	95.24	142.86	190.48	228.57
3.0	1.25	3.13	7.50	9.38	12.50	15.63	31.25	37.50	62.50	93.75	125.00	150.00
3.5	0.89	2.22	5.33	6.67	8.89	11.11	22.22	26.67	44.44	66.67	88.89	106.67
4.0	0.67	1.67	4.00	5.00	6.67	8.33	16.67	20.00	33.33	50.00	66.67	80.00
4.5	0.52	1.30	3.12	3.90	5.19	6.49	12.99	15.58	25.97	38.96	51.95	62.34
5.0	0.42	1.04	2.50	3.13	4.17	5.21	10.42	12.50	20.83	31.25	41.67	50.00
5.5	0.34	0.85	2.05	2.56	3.42	4.27	8.55	10.26	17.09	25.64	34.19	41.03
6.0	0.29	0.71	1.71	2.14	2.86	3.57	7.14	8.57	14.29	21.43	28.57	34.29
6.5	0.24	0.61	1.45	1.82	2.42	3.03	6.06	7.27	12.12	18.18	24.24	29.09
7.0	0.21	0.52	1.25	1.56	2.08	2.60	5.21	6.25	10.42	15.63	20.83	25.00
7.2	0.20	0.49	1.18	1.48	1.97	2.46	4.92	5.90	9.83	14.75	19.67	23.60
7.5	0.18	0.45	1.09	1.36	1.81	2.26	4.52	5.43	9.05	13.57	18.10	21.72
8.0	0.16	0.40	0.95	1.19	1.59	1.98	3.97	4.76	7.94	11.90	15.87	19.05

Protection mode	OFF / Alarm / Trip
K factor value	10 ~ 1200
Cool down timer	1 ~ 1200 min
Failure reset	Manual / Auto

Cool down timer:

After motor stop, the cool down timer countdown to simulated the motor cools to a safe state process; the definition of the cooling time is to reach steady state of ambient temperature (the maximum allowable temperature) when motor overload trip. Typically, cool timer can set to 30 minutes as heat capacity values decreased from 100% to 15%.

7.3- Phase failure protection

When motor meet phase failure (Any of two phase over 25% of the rated current, another phase less than 12.5% of the rated current), will trip the phase failure protection.

Protection mode	OFF / Alarm / Trip
Trip delay	0.1 ~ 50.0 s

7.4- Stall protection

Stall protection to prevent motor-driven equipment in serious operation block or motor overload operation and heat damage to the motor,

Note: Stall protection only be act after the motor starter is complete.

Protection mode	OFF / Alarm / Trip
Threshold	100 ~ 1000%Ie
Trip delay	0.5 ~ 50.0 s

7.5- Current imbalance protection

Current imbalance protection based on the maximum phase current imbalance to determine whether to start phase unbalance protection function. Current unbalance is calculated as follows:

$$I_{im} = \frac{|I_{max} - I_{avg}|}{I_{avg}} \times 100\% \quad \text{or} \quad I_{im} = \frac{|I_{max} - I_{avg}|}{I_{avg}} \times 100\%$$

I_{im} -- Three-phase current imbalance;

I_{max} -- Maximum phase current in the real-time measurement of three-phase;

I_{min} -- Minimum phase current in the real-time measurement of three-phase;

I_{avg} -- Three-phase average current.

Notes: When the three-phase average current (I_{avg}) is less than the motor rated current (**Ie**), in formula $I_{avg} = Ie$

Protection mode	OFF / Alarm / Trip
Imbalance threshold	5 ~ 60 %
Trip delay	0.1~ 50.0 s

7.6- Under load protection

If motor load occurs abnormal mutations, such as belt break or pump idling, define this situation is under load. Typically set under load protection in alarm mode, to let site worker pay attention.

Protection mode	OFF / Alarm / Trip
Threshold	20 ~ 100 %Ie
Trip delay	0.5 ~ 50.0 s

7.7- Rotor Jam protection

Compare the motor maximum measured current value and motor rated current in the starting process, to determine whether to act the protection.

Note: Jam protection only be act in the starting process, after motor normal working will be automatic locked.

Protection mode	OFF/Alarm/Trip
Threshold	100 ~ 1000% Ie
Trip delay	0.5 ~ 50.0 s

7.8- Ground Fault Protection(Optional)

If any part of winding comes in contact with the ground, then we can say the motor is earthed. Device use external CT to detect residual current, ideal state to set the low residual current failure action values to protect as much stator coil and prevent the motor casing with electricity and dangerous.

In direct grounding system should be set short delay time to avoid damage; In resistance grounding system, the value of the residual current is limited within the safe range, user can choose a longer delay time.

Protection mode	OFF / Alarm / Trip
residual current threshold	10 ~ 100%IΔn
Trip delay	0.1 ~ 5.0 s

7.9.- tE Protection

The tE protection function used for increased safety(IEC-60079-7) type motor, it provides 8 extra inverse time protection curves, to avoid unexpected overheat status.

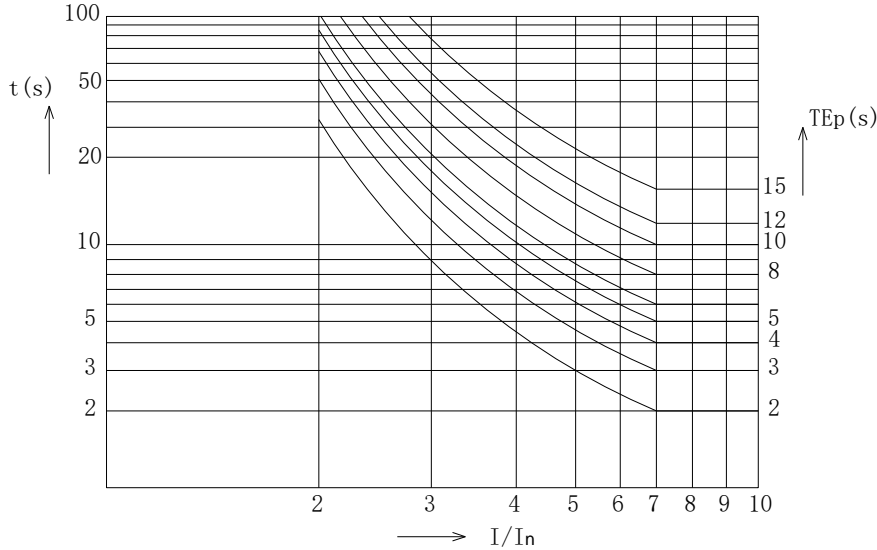

tE tripping characteristic

I/I_e \ t_{Ep}	1.0(s)	4.0(s)	4.3(s)	4.6(s)	5.0(s)	5.5(s)	6.0(s)	15.0(s)
3.00	4.00	16.00	17.20	18.40	20.00	22.00	24.00	60.00
3.20	3.48	13.92	14.96	16.01	17.40	19.14	20.88	52.20
3.40	3.08	12.32	13.24	14.17	15.40	16.94	18.48	46.20
3.60	2.76	11.04	11.87	12.70	13.80	15.18	16.56	41.40
3.80	2.50	10.00	10.75	11.50	12.50	13.75	15.00	37.50
4.00	2.29	9.16	9.85	10.53	11.45	12.60	13.74	34.35
4.20	2.11	8.44	9.07	9.71	10.55	11.61	12.66	31.65
4.40	1.95	7.80	8.39	8.97	9.75	10.73	11.70	29.25
4.60	1.82	7.28	7.83	8.37	9.10	10.01	10.92	27.30
4.80	1.70	6.80	7.31	7.82	8.50	9.35	10.20	25.50
5.00	1.60	6.40	6.88	7.36	8.00	8.80	9.60	24.00
5.20	1.51	6.04	6.49	6.95	7.55	8.31	9.06	22.65
5.40	1.43	5.72	6.15	6.58	7.15	7.87	8.58	21.45
5.60	1.36	5.44	5.85	6.26	6.80	7.48	8.16	20.40
5.80	1.29	5.16	5.55	5.93	6.45	7.10	7.74	19.35
6.00	1.23	4.92	5.29	5.66	6.15	6.77	7.38	18.45
6.20	1.18	4.72	5.07	5.43	5.90	6.49	7.08	17.70
6.40	1.13	4.52	4.86	5.20	5.65	6.22	6.78	16.95
6.60	1.08	4.32	4.64	4.97	5.40	5.94	6.48	16.20
6.80	1.04	4.16	4.47	4.78	5.20	5.72	6.24	15.60
7.00	1.00	4.00	4.30	4.60	5.00	5.50	6.00	15.00
8.00	1.00	4.00	4.30	4.60	5.00	5.50	6.00	15.00

Note:

- The setting value of tE trip delay will transfer to actually trip time refer above chart
- To ensure that the regular overload protection act before tE trap time, we suggest choose lower inverse time curve in overload protection, typically less 15%.

Protection mode	OFF / Alarm / Trip
Trip delay	0.1 ~ 5.0 s

8- I/O Output (Optional)

8.1.- Analog output port

PR200 can provide 1 channel analog output port, can provide 4 ~ 20mA signal to PLC or other device, user can free to select the transmit electrical parameters: Ia, Ib, Ic, Iavg

Note: Analog output port cannot be choosing with the ground fault protection function.

8.2.- Digital output port

PR200 can choose extra 2 channels digital output, the physical DO relay standard is 5A 250VAC / 5A 30VDC.

*Remote mode operation

In “Remote” mode, user can use function code 05 to trig single relay, device RS-485 port follow MODBUS-RTU protocol, command as following:

Host inquiry:

01	05	00 01	FF 00	DD FA
Address	Code	No.1 Relay register	Relay value (FF00:close; 0000: open)	CRC

Slave answer:

01	05	00 01	FF 00	DD FA
----	----	-------	-------	-------

Detail operation please refer to [chart 5.5- Programming menu structure introduction](#)

8. - SAFETY CONSIDERATIONS



All installation specification described at the previous chapters named:
INSTALLATION AND STARTUP, INSTALLATION MODES and SPECIFICATIONS.

Note that with the instrument powered on, the terminals could be dangerous to touching and cover opening actions or elements removal may allow accessing dangerous parts. This instrument is factory-shipped at proper operation condition.

9. - MAINTENANCE

The PR200 series not require any special maintenance. No adjustment, maintenance or repairing action should be done when the instrument is open and powered on, should those actions are essential, high-qualified operators must perform them.

Before any adjustment, replacement, maintenance or repairing operation is carried out; the instrument must be disconnected from any power supply source.

When any protection failure is suspected to exist, the instrument must be immediately put out of service. The instrument's design allows a quick replacement in case of any failure.

For any inquiry about the instrument performance or whether any failure happens, contact to Blue Jay's technical service.

Blue Jay - After-sales service

E-mail: tech@cqbluejay.com

Tel: +0086-023-67628702
www.cqbluejay.com
Add: 1802, Building 2, No.88, Jianxin East Road, Chongqing, 400020, China

Email: tech@cqbluejay.com