

MINI DC Power Supply System

User manual

Contents

Chapter1 System overview.....	3
1. Model description	3
Chapter 2 Rectifier Modules.....	4
1. Introduction	4
3. Specification	7
Chapter3 Monitor module.....	9
2. Features and Functions.....	10
2.1. Input specification.....	10
2.2. Display and setting.....	10
2.3 Control functions.....	16
2.4 Complete communication functions.....	16
2.5 Alarm & Record.....	16
2.6 Automatic battery management	17
2.7 Communication.....	17
2.8 Dry contact output.....	17
Chapter4 Rack system.....	
1. Front panel	
2 Back panel.....	
3. Communication Dry Contact.....	
Warranty Card	20

Chapter1 System overview

1. Model description

System Model

MINI

MINI: mini system, high Power density

Rectifier Model

30120

30: Power, Unit is hundred, that is 3000W

120: Output voltage 120Vdc

Monitor Model

M30

M: Monitor

30: match with 30120 module etc.

2. System structure

The system configuration is flexible. All the functional modules are easy to embed into the system.



3. System Feature

MINI embedded DC power systems advanced modular design makes the whole system are small, but it can provide enough power to meet the requirements of communication systems, consistent with the characteristics of the rack-mounted. The system is suitable for all sizes of exchange room, base stations, satellite communications, data communications, railways and power systems. MINI DC power system is easy to operate, install and maintain. Module subrack adopts inset-box installation for flexible expansion capacity and replacement controller.

Features:

- With active power factor compensation technology power factor of rectifier is up to 0.99
- Standard height 2U, the weight of each module is 2.6kg and output current is Max 20A , with high power density.
- ★ Rectifier modules adopted soft switch technology. When load rate is 10%, efficiency can be **91%**; 50% load rate , the efficiency can be above **95%**
- Complete battery protection and load disconnect management. It has LVD function, which maximizes to protect battery.
- Rectifier and monitor modules adopt hot swap technology, Plug and play;
- Standard RS232 communication interface; 3-class alarm dry contact: Emergency alarm, main alarm and minor alarm.
- Complete fault protection, alarm function;
- Low radicalization: Advanced EMC rectifier design can meet the communication power rectifier equipment electromagnetic compatibility limits and measurement methods in the PRC telecommunications industry and standard YD/T983 conducted and radiated interference requirements.
- System configuration is flexible and easy to expand; N +1 redundant power supply. It can be configured according to customer demand;
- ★ Products have passed the inspection of the Ministry of Information Industry Quality Supervision and Inspection Center.

Chapter 2 Rectifier Modules

1. Introduction



Our rectifier modules adopt pure resonant soft-switching technology and Plug and play. Each module is equipped with advanced microprocessors. On the front panel, each

rectifier modules has 3 Led indicators: power supply indicator, communication indicator and failure indicator.

Indicators	Normal state	Abnormal states	Reasons
Power supply Indicators	On	Off	No AC input or input fuse is damaged
Communication Indicators	Off	Twinkling	Communication fail
Failure Indicators	Off	On	There is a damage inside the module

2.Functions :

•Soft switch

Rectifier power circuit is divided into active PFC and DC to DC converter which can make the wide input voltage range (75V-300V) and high efficiency (above 97%). High power density has reached the international advanced level. Efficiency curve is shown as below.

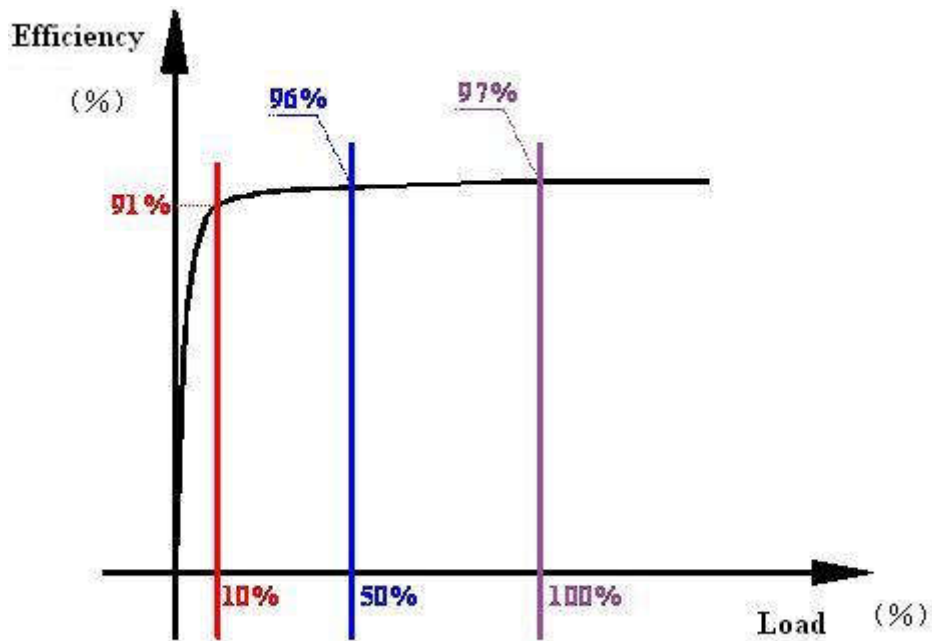

- **Forced wind cooling**

Advanced design of Circuit makes for low-heating with heat sink.

- **Hot swappable**

The monitoring module is hot-pluggable. When the module is plugged into the system, it will not cause the system output voltage fluctuations. Damaged modules can be replaced in less than 1min without stopping the system operation.

- **Protection & failure alarm**

In different protection / fault types rectifier has different reaction / action mode.

- **Auto equalized output in low-gap voltage of modules**

Adopted auto equalized output in low-gap voltage of modules technology. When the monitor module or individual rectifier is failure the other modules can maintain current sharing.

- **Stepless limiting technology**

With stepless limiting technology, it can be continuously adjusted between rated current 0~110%

- **Monitor**

Monitor has built-in CPU, monitoring the operation status of modules, and is responsible for the communication. The rectifier module receive ON/OFF current limit point and voltage setting sending by monitor through RS485, and send back the voltage, current, temperature limiting point ON/OFF status and alarm in real time to the monitor module.

- **Fan control and dust-proof**

Stepless temperature control fan speed, and change with the output power of module, which minimize noise and extend fan life.

3. Specification

1. Environment

Work temperature: $-25^{\circ}\text{C} \sim 45^{\circ}\text{C}$

Storage temperature: $-40^{\circ}\text{C} \sim 70^{\circ}\text{C}$

Relative humidity: $\leq 97\%RH$

Height above sea level: $\leq 3000\text{m}$

2. Input properties

Input $75 \sim 175\text{Vac}$, output power: 1500W, output current: 10A

Input $175 \sim 300\text{Vac}$, output power: 3000W, output current: 20A

3. Output properties

120VDC output, maximum output power 3000W

DC output voltage $90\text{V} \sim 150\text{V}$, It can be continuously adjusted by monitoring module

DC output current $0\text{A} \sim 20\text{A}$

Voltage regulation precision: $\leq 0.6\%$

Load regulation: $\leq 0.5\%$

Voltage regulation: $\leq 0.1\%$

4. Output current-limiting properties

In the range of 0 ~ 110% rated current can be continuously adjusted.

5. Power factor: ≥ 0.99

6. Efficiency: $\geq 95\%$

7. equalized-current imbalance: $\leq 3\%$

8. Temperature compensation coefficient: Can be set manually, unit (mV/°C)

9. Dc output noise:

Peak noise voltage: $\leq 200\text{mV}$ 0 ~ 20MHz

Weighted psophometric noise voltage: $\leq 2\text{mV}$

Wide frequency noise voltage: $\leq 50\text{mV}$ 3.4kHz ~ 150kHz
 $\leq 20\text{mV}$ 0.15 MHz 30MHz

Discrete noise voltage: $\leq 5\text{mV}$ 3.4kHz ~ 150kHz
 $\leq 3\text{mV}$ 150kHz ~ 200kHz
 $\leq 2\text{mV}$ 200kHz ~ 500kHz
 $\leq 1\text{mV}$ 0.5MHz ~ 30MHz

10. Noise: $\leq 45\text{dB}$ (A)

11. Alarm & Protection

1) Over-current protection

Over-current protection of input (use fuse)

Over-current protection of output (use fuse)

Over-current protection of PFC (use diverter)

Short circuit protection (reduce input current to protect)

2) Over-voltage & low-voltage protection (The following parameters can be adjusted by hardware.)

Input low-voltage protection: $75\pm 5\text{V}$, hysteresis: 10V ~ 20V

Input over-voltage protection: $300\pm 5\text{V}$, hysteresis: 5 ~ 20V

Output over-voltage protection: 155 ±1V

3) Other protection

Over- temperature protection (default value 80°C, hysteresis: 10°C)

12. Size of the module:

88mm(H)×103mm(W)×261mm(D)

13. Weight: ≤2.6Kg

Chapter3 Monitor module



1. Appearance

M16 monitoring module has LCD screen (128*64 Blue background white text), key and indicators. It can display data of the system in real time and setup by keys.

Indicators	Normal	Abnormal	Reasons
Power supply indicator	On	Off	No AC input or input fuse is damaged
Equalized &float charging indicator	Off	On	Equalized charging(On) Float charging(Off)
Failure indicators	Off	On	There is a damage inside the system

Advanced microprocessors make accurate, reliable and fast.

It has local control and remote monitoring, truly intelligent system.

2. Features and Functions

2.1. Input specification





Rating DC input voltage: 120VDC



Range of voltage: 90V~150VDC

Work temperature: -25°C~ 45°C

2.2. Display and setting

Monitor module will display: operating parameter, states, warning, setting parameter and control parameters.

Key Description: There are 4 bottoms on the monitor panel: “”, “↑”, “↓”, “”. Press “” to change the parameter. Press “↑”, “↓” to change its data, and “” to save.

keys: “” “↑” “↓” “”. Press the keys to change the data, and save the change.

Operation process and instruction

1. Screensaver:

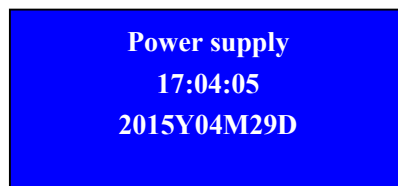

Display the current time and date. Press “” to enter system information menu.

2. System information menu:

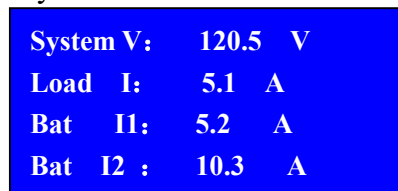

Display the current system voltage (online voltage), load current, battery current and module current. Press “” to enter the password menu .

3. System information menu

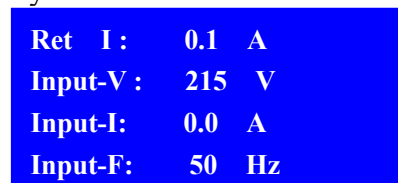

Display AC input voltage, AC input current and AC input frequency. Press “” to enter the password input menu

4. System information menu

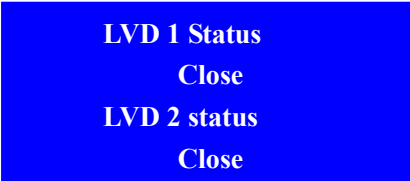

LVD 1 Status
Close
LVD 2 status
Close

Display LVD Status.

Press “↵” to enter the password input menu

5. System information menu:



Bat temp : 32.1℃
Chg mode: Float
Now has 0 Alarms
Look >>

Display battery temperature, charge mode (Equalized/Float charging) and the alarms event.

Press“↵”to view more alarms content

6. Modules information:

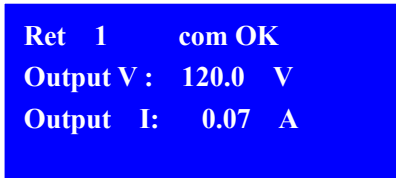

Ret 1 com OK
Output V : 120.0 V
Output I: 0.07 A

Display module 1-N info.

Press “↑” “↓” to check the other modules information. Press “↵” to enter the password input menu

7. Input password:



Input password
0 0 0 0

The default password is 0000. The user can enter the system menu to change your password.

8. Main menu:

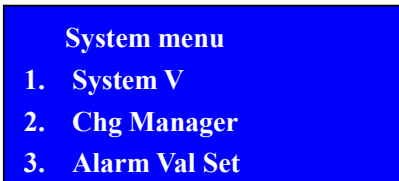

System menu
1. System V
2. Chg Manager
3. Alarm Val Set

Press “↑” “↓” to choose the item, and press “↵” to view the details.

9. Main menu:

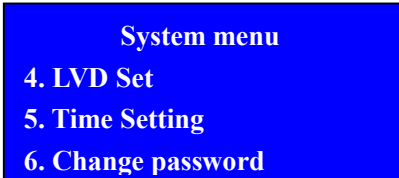

System menu
4. LVD Set
5. Time Setting
6. Change password

Press “↑” “↓” to choose the item, and press “↵” to view the details.

10. Main menu:

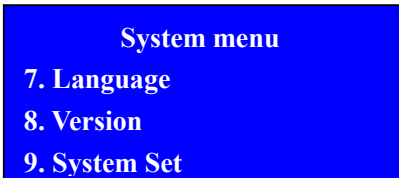

System menu
7. Language
8. Version
9. System Set

Press “↑” “↓” to choose the item, and press “↵” to view the details.

11. System voltage setup :

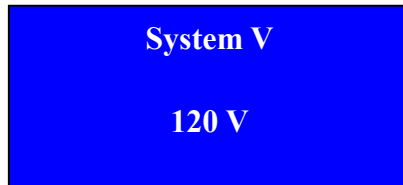

Set System float voltage.
Press “↑” “↓” to change the value, and press “↵” to confirm.

12. Charge management :

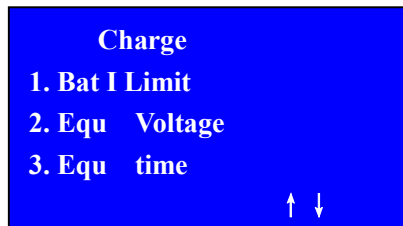

Press “↑” “↓” to choose the item, and press “↵” to view the details.

13. Charge management :

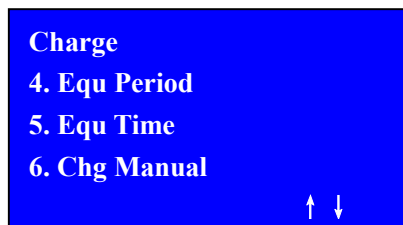

Press “↑” “↓” to choose the item, and press “↵” to view the details.

14. Charge management :



Press “↑” “↓” to choose the item, and press “↵” to view the details.

15. Battery charge current limit value:

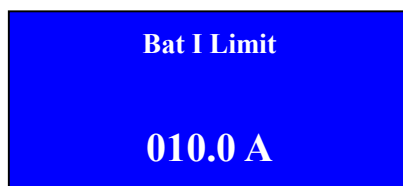

Set battery charge limit value

16. Value of Equalized Charging voltage:



Set value of Equalized Charging

17. Value of Equalized charge time:

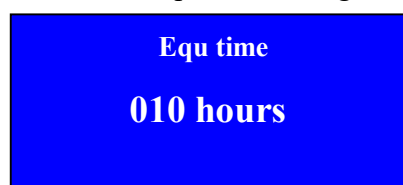

Value of Equalized charging time

18. Value of Equalized charge period

Equ Period
05000 hours

Value of Equalized charge interval

19. Equalized charging in specified time:

Equ time
17: 26: 26
12 – 04- 30

Set the specified charging time. When the time reaches the specified time, the charging status will change to Equalized charge, and the output of system is also Equalized voltage

20. Manual set Equalized /Float charging.

Chg Manual
1.manual Float
2.manual Equ

The user can change the charging model manually. When set OK, the charge time will start from 0.

21. Temperature compensates:

Temp compensate
Coeffi: 000 mV
Compen start: 0 °C

It can set compensation coefficient the starting point. For example, the coefficient is 2mV, and the starting point 40°C, the output voltage should minus 20mV at 50°C.

22. Set alarm limit value:

Alarm Val Set
1. Bat High-V Set
2. Bat Low-V Set
3. Input Over-Vol

Here, it can set the values of battery high/low voltage and AC over voltage alarm value.

23. Set alarm limit value:

Alarm Val Set
4. Input under-Vol
5. Input Over-Cur
6. Freq Range Set

Set AC under voltage value, AC over current value and AC frequency range value

24. Set alarm limit value

Alarm Val Set
7. Temp High Set
8. Sound Set

Set battery temperature alarm value and alarm sound control (ON/OFF).

25. Set over voltage alarm value:

Bat High-V Set
150.0 V

Set overvoltage value. When the system voltage exceeds this value, the system will shut down the module and not recoverable.

26. Set under voltage alarm value:

Bat Low-V Set
90.0 V

Set under voltage alarm value. When the system voltage is below this value, the system will sound single audible alarms.

27. Set AC over voltage alarm value

Input Over-Vol
300 V

AC overvoltage setting. When the AC voltage is higher than this value, the system will sound single audible alarms.

28. Set AC under voltage alarm value

Input Under-Vol
075 V

AC under voltage setting. When AC voltage is below this value, the system will sound single audible alarms.

29. Set AC over current value

Input Over-Cur
010A

AC over current setting. When AC current is over this value, the system will sound single audible alarms.

30. Set AC frequency range

Freq Range Set
20%

AC frequency range setting. When AC frequency is over this range, the system will sound single audible alarms.

31. Set temperature alarm value

Temp High Set
40.0°C

Set the battery temperature alarm value. When the battery temperature is over this value, the system will sound single audible alarms.

32. Audible alarm setting

Sound Set
1. ON
2. OFF

The user can set if the system will sound alarm or not. The default is ON.

33. Low voltage disconnection set

LVD Set
1. LVD 1 Setup
2. LVD2 Setup

2-class LVD.
press “↵” to view the details.

34. LVD 1

LVD 1 Setup
Open V 98.0 V
Close V 100.0 V

Low voltage disconnection 1 connects the main load. When the battery voltage is shortage, the main load disconnected. When the battery voltage is recovery to the working voltage, it will automatically work.

35. LVD 2

LVD 2 Set
Open V 100.0 V
Close V 102.0 V

Low voltage disconnection 2 connects the main load. When the battery voltage is shortage, the main load disconnected. When the battery voltage is recovery to the working voltage, it will automatically work.

36. Set time

Time Setting
18:51:56
15-4-29

Set system time and date.

37. Reset password

Input New
0 0 0 0

Here to change the new password. Input new password, and press “↵”.

38. Language

Language
1.Chinese
2. English

Select the language.

39. Version



Monitor device version.

40. System Set configuration

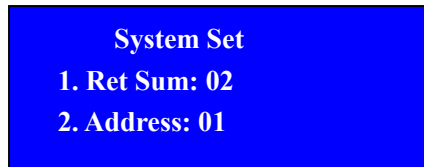

Configure the number of modules of the current system.

2.3 Control functions

The MINI System can release control signals according to the operation of the system. Monitor module supports both automatic and manual battery management. Manual mode includes: equalized/float charging of battery groups, adjust rectifier modules voltage (it can change the system voltage), and set battery charging time. In automatic mode, the device will automatically complete the battery charge management according to charge interval and the specified date. When the system works, it can also change the charge mode (equalized or float charging). That is manual mode. In manual mode, all timing starts from zero, and continue to timing by the automatic mode, which can effectively prevent human operational errors to result in losses.

2.4 Complete communication functions

Host can monitor and control all the parameters, the status of the lower machine. At the same time, for safety and reliable, the host and the lower machine not only install the communication protocol to constrain each other, but also must know the monitor password of the lower machine, and sent it to the lower machine, when the host wanted to get the all parameters of the lower machines or monitor the lower machine. After the lower machine checked correctly, it can monitor and control. This is to ensure the stability of the power and avoid unnecessary losses caused by human.

2.5 Alarm & Record

Monitoring module has sound and light alarm function according to collect data and a corresponding action. The main alarms are emergency, main and minor.

2.6 Automatic battery management

Monitor module can implement various conservation measures to protect the battery, such as charging current limit, temperature compensation according to user set data, and charging current limit, average and float charge conversion time, average and float charge voltage etc. battery charging methods.

2.7 Communication

Monitor module has the host and the lower device communication functions. It communicates with the host by RS232; communication with the lower device by RS485.

2.8 Dry contact output

There are 3 dry contact outputs.

Emergency dry contact: Mains failure, LVD1, LVD2, over-voltage module, module fan failure.

Main dry contact: Battery fuse alarm, MCB alarm.

Minor dry contact: battery temperature alarm, communication failure.

Chapter4 Rack system

1. Front panel

5pcs 110v 20A rectifier modules, 1pcs monitor (From left to right place)

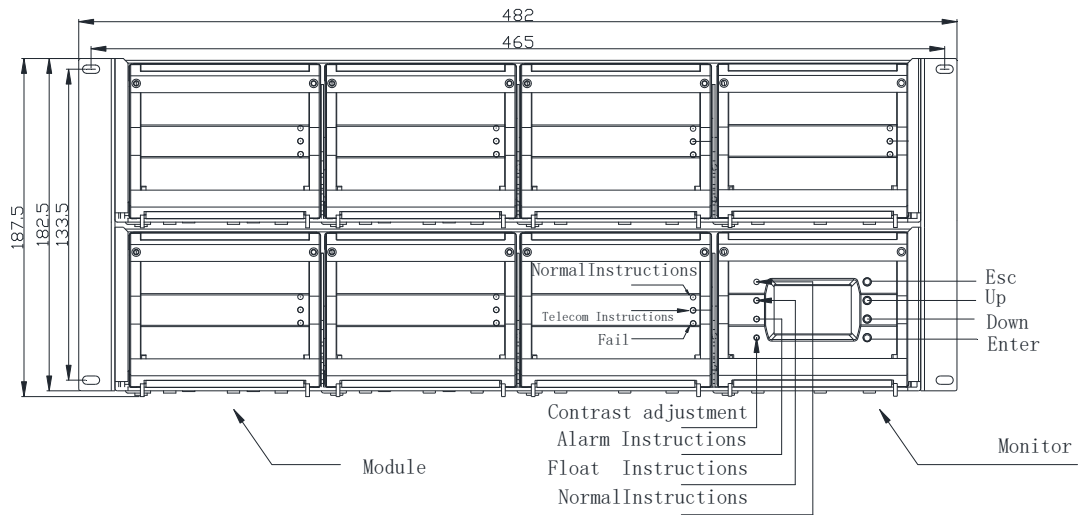

2 Back panel

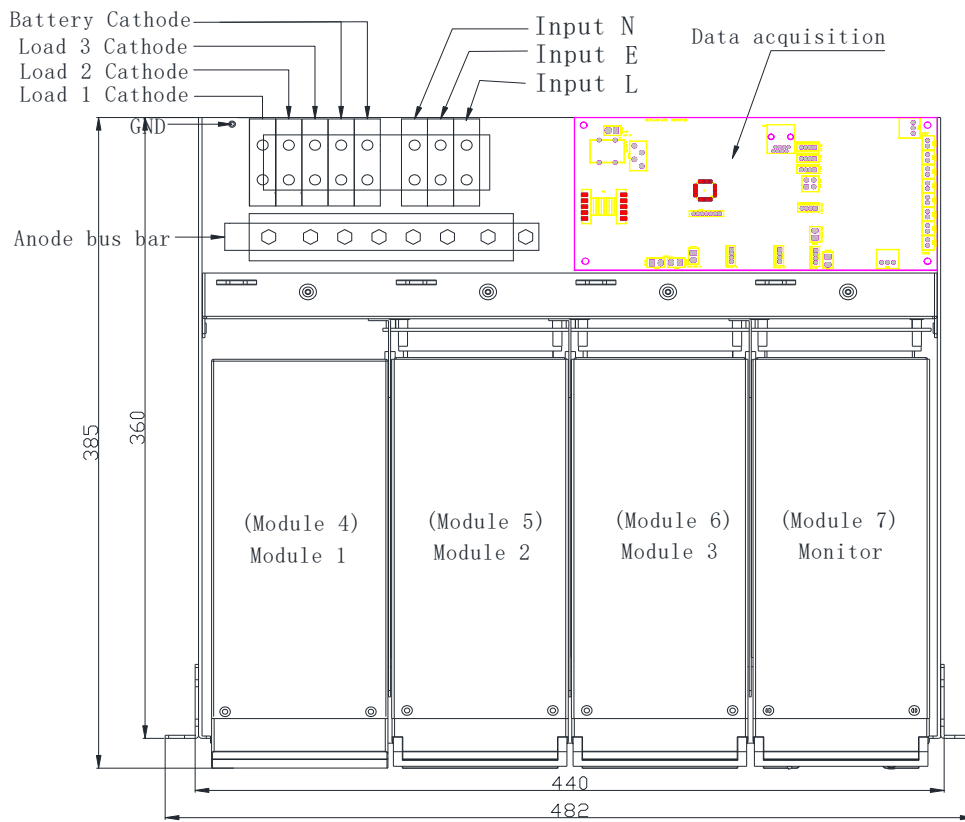

3. Communication Dry Contact

The communication interface and dry contact interface sketch map as below:

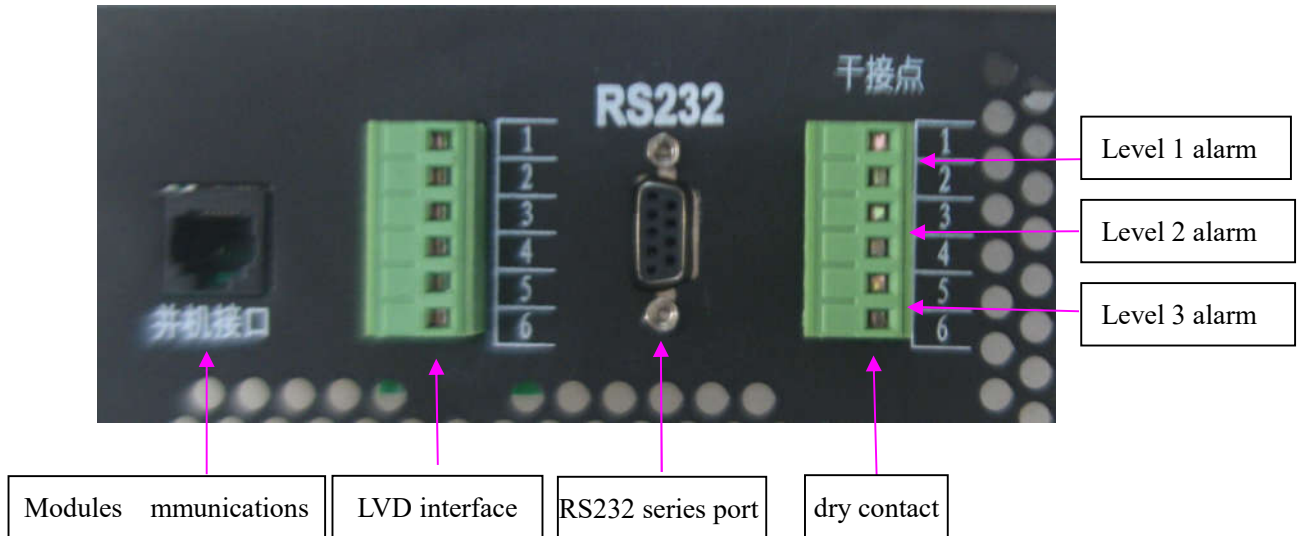

1. About dry contact:

Level 1: line lack of phase、 low-vol break away、 modules over-vol、 failure of modules fan

Level 2: loads switch alarm、 batteries switch alarm

Level 3: batteries over-tem, modules communications

2. The LVD interface specification:

Above picture, from top to bottom: 2-3: LVD1; 4-5: LVD2. 1, 2, used for system extension.

Two coil control signal lines of contactor, connected to 2 and 3 hole (contactor signal lines irrespective of positive or negative) it can achieve the first level LVD,

If connect to 4 and 5 hole, it can achieve the second level LVD,

1 and 6 hole designed for the realization of the function extension.

Warranty Card

To ensure good quality product, the MINI power supply system was thoroughly

checked before leaving the factory. The manufacturer guarantees to the user that the system is in good condition. The manufacturer provides 2-years warranty service from date of delivery to the original purchaser

Please refer to the warranty statement.

User's Information

User Company: _____	Contact person: _____
Address: _____	Phone: _____
Dealer company: _____	Post code: _____
Model: _____	Serial number: _____
Purchase date: _____	Handling person: _____

Repair Record

Date	Record	Abstract	Technician	Signature