

WSK-72-W1S1K3 Temperature & Humidity Controller

User Manual



Version: 1.10

Revision: 2024.11

Read me

When you use WSK-72 Series Digital-type Temperature & Humidity controller, be sure to carefully read this user manual, and be able to fully understand the implications, the correct guidance of operations in accordance with user manual, which will help you make better use WSK-72 series Temperature & Humidity controller, and help to solve the various problems at the scene.

1. Before the meter turning on the power supply, be sure that the power supply within the provisions of the instrument;
2. When installation, the current input terminal must non-open, voltage input terminals must Non-short circuit;
3. Communication terminal (RS485) is strictly prohibited to impose high pressure;
4. Be sure the instrument wiring consistent with the internal system settings;
5. When communicating with the PC, instrument communication parameters must be consistent with the PC.



- **Please read carefully before using this user manual**
- **Please save this document**

Directory

1.- SUMMARIZE	- 1 -
2.- SPECIFICATIONS	- 2 -
3.- INSTALLATION AND START-UP	- 3 -
3.1- PANEL MOUNTING	- 3 -
3.2.- CONNECTION DRAWING FOR THE WSK-72-W1 S1K3	- 5 -
4.- OPERATION MODE	- 6 -
5.- SETUP PROCEDURE	- 7 -
5.1.- PASSWORD ENTER	- 7 -
6.- SAFETY CONSIDERATIONS	- 9 -
7.- MAINTENANCE	- 9 -

1.- SUMMARIZE

WSK-72 Series Temperature and Humidity Controller is a measurement device used on temperature and humidity control. and the humidity control module is integrated in the system, greatly improving the suitability of the equipment, obtaining the temperature and humidity change from the sensor and sending the measured data to the electronic processor. The output device will then control the temperature variation within a specific range.

With high technological content, using load control relay output, has fast output response, accurate PID parameter auto-tuning, support, Modbus communication protocol and is built-in with various output types, allowing different systems to reach a stable control status very quickly, can be used in the worst environment for long-term use, applied to the various occasion which need temperature and humidity control.

It is the ideal product to protect the normal efficient operation of power equipment and to reduce cost. And can be used in other place need of temperature and humidity control.

FEATURES

- Support multi sensor input (K, S, Wre, T, E, J, B, N, CU50, PT100);
- Wide control range -50~99°C;
- Indication and control accuracy 0.5°C, high measurement;
- Accuracy $\pm 0.2\%$ FS;
- Use large capacity relay;
- Output and alarm format can be set by user;
- Built-in digital filter reduces interfere;
- Self-calibration technology, keep stabilization;
- 0.39" height LED, prevent dazzle, highly visible display
- Switching power supply and low consumption.

APPLICATION

- High and low voltage switchgears;
- Industrial temperature regulation;
- Automotive cooling systems;
- Air conditioners, HVAC systems;
- Medical equipment temperature regulation.

Note:

Temperature range can be changed to meet user need, please confirm with Blue Jay sales team before order.

2.- SPECIFICATIONS

Basic Parameters

Power supply	AC220V \pm 20%, 1PH 50Hz
Power consumption	\leq 1.8W
Dimension	72W x 72H x 123D mm

Control Output

Relay output	2-Route 250VAC, 5A 1PH, resistive load
--------------	--

Input

Temperature	-40~99°C
Temp sensor accuracy	+/-0.2 °C
Humidity	1~98%RH
Hum sensor accuracy	+/-3.0%RH
Cable length	2 m.(3m option)
Sampling rate	400 msec /per scan

Display

Display method	2-line x 3 character 7-segment LED display
Keypads	Menu, Enter, Increase, Decrease

Environment

Protection (TH)	Anti-containing acid, alkali, salt gas
Relative humidity	<93%, Non-condensing
Storage environment	-10~55°C ; 20 ~ 93%RH ; Noncondensing

3.- INSTALLATION AND START-UP



The manual you hold contains information and warnings that -users should follow in order to guarantee a proper operation of all the instrument functions and keep it in safety conditions. The instrument must not be powered on and used until its definitive assembly is on the cabinet's door.

If the instrument is not used as manufacturer's specifications, the protection of the instrument will be damaged.

When any protection failure is suspected to exist (for example, it presents external visible damages), the instrument must be immediately powered off. In this case contact a qualified service representative.

3.1- Panel mounting

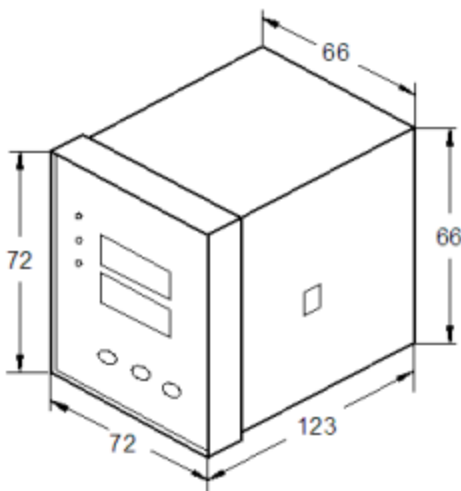

WSK-72-W1S1K3 is for panel mounting, controller is to be mounted on panel (cut-out 66+0.5 x 66+0.5 mm). All connections keep inside the cabinet.

1. Insert the controller through the panel cutout.
2. Insert the mounting bracket into the mounting groove at the top and bottom of the controller and push the mounting bracket forward until the bracket stops at panel wall.
3. Completion status.

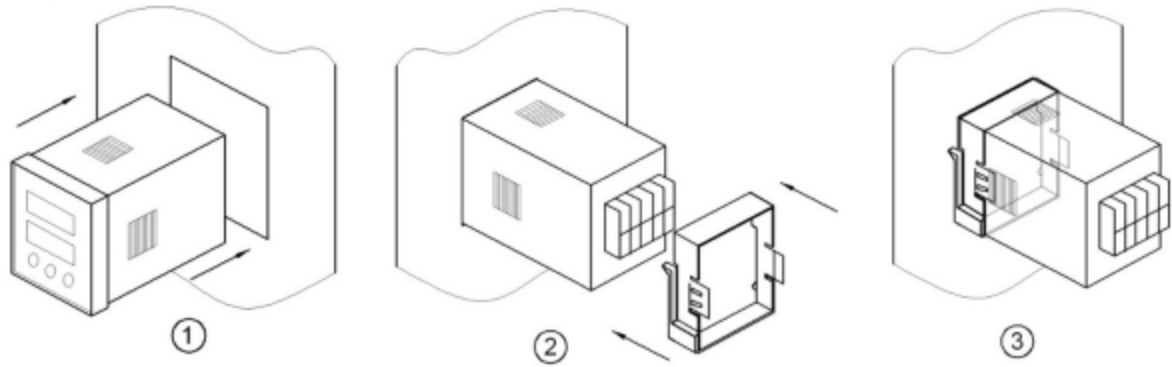

Notes:

1. The controller must not be power on until this is completely installed;
2. Panels shall not exceed 12 mm maximum thickness, if more than this range, please consider using the rail mounting.

3.2.- Connection Drawing for the WSK-72-W1S1K3

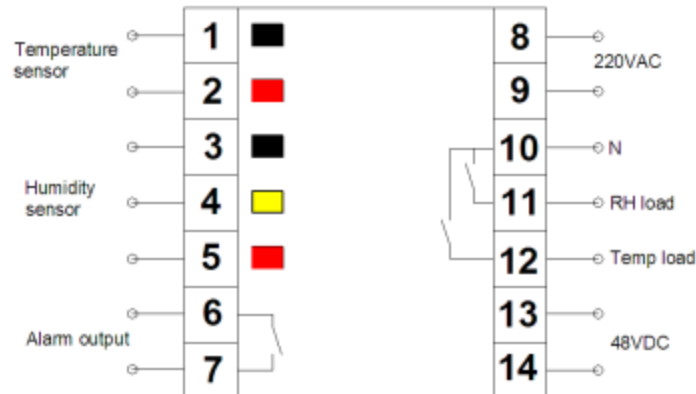

- | | |
|--|-------------------------------------|
| 1.- connect temperature sensor BLACK wire | 8- power supply (+) |
| 2.- connect temperature sensor RED wire | 9- power supply (-) |
| 3.- connect humidity sensor BLACK wire | 10- connect to common neutral |
| 4.- connect humidity sensor YELLOW wire | 11- connect to humidity load (+) |
| 5- connect humidity sensor RED wire | 12- connect to temperature load (+) |
| 6,7- connect to alarm output (Dry contact) | 13- DC power supply (+) |
| | 14- DC power supply (-) |

Notes:

Temperature load and humidity load use the common neutral pin (10)

That mean temperature load will connect pin (9) for the positive and pin (12) for the negative

Do read and full understanding of the controller wiring, if cannot sure the connection, please contact BLUE JAY technical support tech@cqbluejay.com for more help.

4.- OPERATION MODE

When the WSK-72 Series controller is powered up, all the LED indicator will on, and controller start self- test to check the sensor status. After some seconds, the controller is ready for operation and shows one of the available screens.

Note: If there is any sensor off line, the display will show "  "to indicate the sensor failure.

Button explanation:



Up key: Press this key to increase values displayed on the display. Hold down this key to speed up the incremental action.



Down key: Press this key to decrease values displayed on the display. Hold down this key to speed up the decrements.



Menu key: Pressing the "Menu" key the can open the programming menu and return to previous menu.



Enter key: Pressing the "Enter" key, you exit it with saving any modification that you might have done, in menu operation press "Enter" key; user can go to the next menu.

5.- SETUP PROCEDURE



The SETUP procedure of the WSK-72 series is performed by means of several SETUP options.



Once into the SETUP, use the keyboard to select different options and enter required variables:

1. Password enter
2. Set the temperature control value
3. Set the humidity control value
4. Set the control mode
5. Set the up limit alarm value
6. Set the low limit alarm value







5.1.- Password enter

A 3-figure password is required to be entered (in case that this password is not correct, will not be set on the meter).

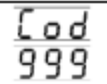
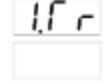
At normal display mode, press "  " to enter the programming mode, meter display, then press  ; Controller display "  " 999 ",

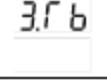
Ask for the password. Press  and  to increase or decrease the number, to switch password. After password switch press "  " to confirm the input.

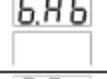
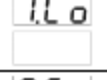
If password is correct, meter can enter to next setting:

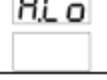
Code	Item	Range	Description
	Password	0~999 (default 001)	Enter when the password entered is correct
	Temperature control	-40 ~ 99°C	Set temperature control value
	Temperature hysteresis	1-9°C	Set temperature hysteresis value
	Temperature compensation	-9.9~9.9°C	Set temperature compensation value
	Humidity control	0~100	Set the humidity control value
	Humidity hysteresis	0~20	Set humidity hysteresis value
	Humidity compensation	-10~10	Set humidity compensation value
	Operating mode	0 ~ 1	0= Rising edge trig (heating type) 1= Falling edge trig (cooling type)
	Address	1 ~ 247	Communication address of RS485
	Alarm control	0.0~99.9	Temp. alarm upper limit value
	Alarm control	0.0~99.9	Temp. alarm lower limit value

Notes:

Not all the WSK-72 series controller has RS485 port, please check the label on product. If your controller does not have the RS485 port, please pass in this section.

Each piece of sensor produced by Blue Jay Technologies Co., Ltd is 100% tested to exacting specifications. But the in the normal use condition, the measurement value will be a slight deviation. For ensure the controller running well, users schedule maintenance personnel, more details please refer to [Chapter 7](#).

6.- SAFETY CONSIDERATIONS



All installation specification described at the previous chapters named: **SPECIFICATIONS, INSTALLATION, OPERATION MODES, and SETUP PROCEDURE**

Note that with the controller powered on, the terminals could be dangerous to touching and cover opening actions or elements removal may allow accessing dangerous parts. This controller is factory-shipped at proper operation condition.

7.- MAINTENANCE

The WSK-72 series controller need to calibration the temperature sensor and humidity sensor in schedule maintenance.

The precision and reliability is very important. We suggested that maintain these sensors in every 3 months:

Step 1: Use a standard meter, which temperature precision is 0.1°C and humidity precision is 3%, to measure the data near the sensors, and recorded for each parameter.

Step 2: Check the displayed real-time sampling value of T, H to compare with the standard value ST, SH.

If the temperature measurement error is more than 1 °C and the humidity measurement error is more than 5%

Please enter the setup menu, and modify **3. Tb** and **6.Hb**.

Before any adjustment, replacement, maintenance or repairing operation is carried out, the controller must be disconnected from any power supply source.

When any protection failure is suspected to exist, the controller must be immediately put out of service. The controller's design allows a quick replacement in case of any failure.

For any inquiry about the instrument performance or any failure, contact to Blue Jay's technical service.

Blue Jay - After-sales service

E-mail: tech@cqbluejay.com

Tel: +0086-023-67628702
www.cqbluejay.com
Add: 1802,Building 2,No.88,Jianxin East Road,Chongqing,400020,China

Email:tech@cqbluejay.com