

DH6-200 Peltier Cooler Dehumidifier

User Manual



Version:1.0

Revision: 2023.11

Read me

When you use DH6-200 Peltier Cooler Dehumidifier, be sure to read this user manual carefully, and be able to fully understand the implications, the correct guidance of operations in accordance with user manual, which will help you make better use of DH6-200 Peltier Cooler Dehumidifier and help to solve the various problems on the site.

1. Always keep safe distance between the high voltage part and the instrument, probe and operator.
2. Measurements must not be taken when thunderstorms are nearby.
3. Do not operate the instrument or accessories in explosive atmospheres.
4. After the battery alarm of the instrument, please turn off the power to charge.
5. Do not open the instrument without permission, this will affect the warranty of the product. The factory is not responsible for self-disassembly.
6. When the instrument is transported, it should avoid rain erosion and prevent collision and falling.
7. When storing and keeping the instrument, attention should be paid to the ambient temperature and humidity, and it should be protected from dust, moisture, shock, acid, and corrosive gas.



- **Please read this user manual carefully**
- **Please save this document**

Directory

1. - SUMMARIZE.....	- 3 -
2. - PRINCIPLE INTRODUCTION	- 4 -
3. - TECHNICAL SPECIFICATION.....	- 6 -
4. - INSTALLATION AND START-UP.....	- 7 -
4.1 - WALL-MOUNTED INSTALLATION DIMENSION (UNIT: MM).....	- 7 -
4.2.- CONNECTION TERMINAL (SEE LABEL ON THE SIDE PART).....	- 8 -
5. - OPERATION MODE	- 9 -
5.1.- KEY DESCRIPTION	- 9 -
5.2.- MANUAL/ AUTO MODE SWITCH.....	- 9 -
5.3.- PARAMETER SETTING PROCEDURE	- 10 -
5.4.- REMOTE CONTROL (OPTIONAL).....	- 11 -
5.5.- RS485 COMMUNICATION (OPTIONAL).....	- 11 -
6. - COMMUNICATION INTERFACE.....	- 12 -
6.1.- MODBUS © PROTOCOL	- 12 -
6.2.- COMMAND SAMPLES	- 13 -
7. - SAFETY CONSIDERATIONS.....	- 17 -
8. - TECHNICAL SERVICE.....	- 17 -

1. - SUMMARIZE

The intelligent dehumidification device adopts the semiconductor refrigeration dehumidification method, actively sucks the humid air in the confined space into the dehumidification duct under the action of the fan, and the water vapor in the air is condensed into water after passing through the semiconductor refrigeration mechanism, and then discharged out of the cabinet through the water pipe Body, can achieve a good dehumidification effect.

By reducing the water content in the air, the relative humidity and absolute humidity are reduced at the same time, the temperature is hardly raised, and there will be no negative impact caused by the temperature difference, which fundamentally eliminates or reduces the occurrence of accidents, and will not accelerate the cabinet due to high temperature. Aging of internal components and cabinets. Effectively prevent safety hazards such as aging of equipment in the cabinet, reduction of insulation strength, breakdown of secondary terminals, mildew of materials and corrosion of steel structural parts, and ensure the safe operation of the power grid.

FEATURES

- Small size, light weight, easy installation.
- Dehumidification ducts actively induce condensation, discharged gas dehumidified by heating
- Automatic/manual dehumidification function optional, temperature and dehumidification start threshold adjustable.
- Humidity and temperature sensor 24-hour real-time sampling, beyond the set start threshold automatically induced condensation.
- Optional RS485 port, support remote control/adjustment of operating parameters and fault reporting function.
- Do not need extra sensor and probe, Optional passive output node for external heater.
- Adopt special moisture-proof components to ensure normal operation in humid environments
- One-way passive output node.

APPLICATIONS

- GIS control cabinet
- High and low voltage control cabinet
- High and low voltage switchgear
- Ring network cabinet, outdoor terminal box
- Mechanical control cabinet, box type substation

2. - PRINCIPLE INTRODUCTION

The intelligent dehumidification device is composed of a power supply system, an air supply system, a semiconductor refrigerator, a temperature and humidity detection control circuit, a heating circuit, a wireless module and a drainage pipeline.

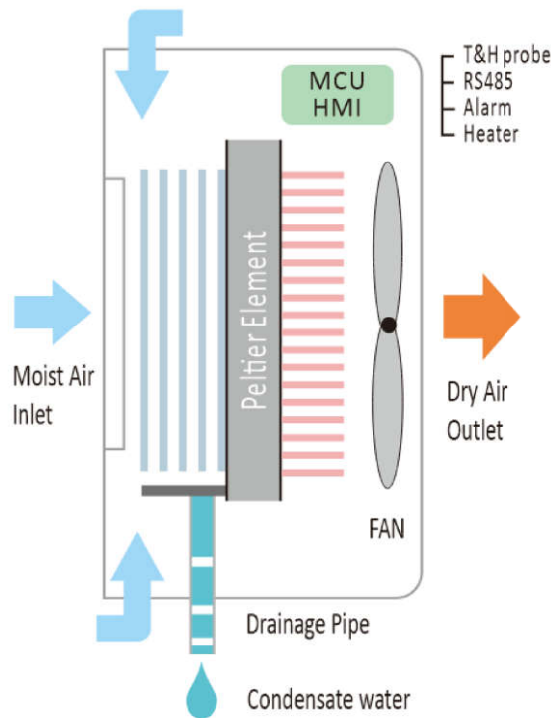

1. Dehumidification principle

After the humid air is sucked by the fan, it flows through the specially designed air duct, and first passes through the semiconductor refrigerator to cool down and condense. After fully dehumidifying within the set starting threshold, the air humidity in the cabinet is reduced to below the dew point, and the entire moisture-proof condensation heating process is completed.

At the same time, the signal acquisition sensor of the intelligent dehumidification device is external, which can accurately collect the real humidity in the cabinet in real time, so as to ensure that the intelligent dehumidification device starts dehumidification in advance when the condensation condition is about to be reached in the cabinet.

2. Heating function(optional)

When the temperature of the box is lower than the set start threshold, Default 5°C, the dehumidification device starts the internal heater circuit (the heater is connected externally, and the power can be connected to 50-500W), until the temperature of the box rises to the set start threshold, the heater circuit stops working.

3. RS485 communication function(optional)

When the dehumidification device with RS485 communication function receives the data from the host computer, it will reply the data to the host computer immediately after analyzing the data. One host computer can connect up to 99 units (the host computer recommends connecting a 120-ohm load between A and B) Resistance, adjustable communication address; remote control, adjustment of operating parameters and fault reporting function).

4. Wireless remote control function(optional)

When the dehumidification device with wireless control function receives the data from the main control room, it will reply the data to the main control room immediately after analyzing the data, and the wireless communication can reach 2000 meters. (Remote control, adjustment of operating parameters and fault reporting function)

Note:

Alarm node: default dry node, equipment failure: default normally open.

3. - TECHNICAL SPECIFICATION

Working power

Power supply	85V~265VAC/DC 50Hz
Peltier rated power	200W
Air volume flow	140m ³ /h
Dehumidifying capacity	650ml/Day, @35°C, 90%RH

Measurement and ability

Humidity monitor range	20%RH~95%RH
Sensor accuracy	±5%RH
Dehumidify start threshold	1%RH~99%RH, Default 75%RH
Environment temperature	5~60°C
Temperature monitor range	-40~80°C
Sensor accuracy	±1.0°C
Heater start threshold	1~55°C, Default 5°C
Heater power	50~500W optional

Other

Aqueduct	Silicone D10mm, L1.5m
Physical dimension	240X245X68mm
Material	Sheet metal with anti-rust spray
Screen	2*3 digital LED
Standards	IEC60255-22-1
Communication	RS485, Modbus-RTU (Optional)

4. - INSTALLATION AND START-UP

4.1 - Wall-mounted installation dimension (unit: mm)

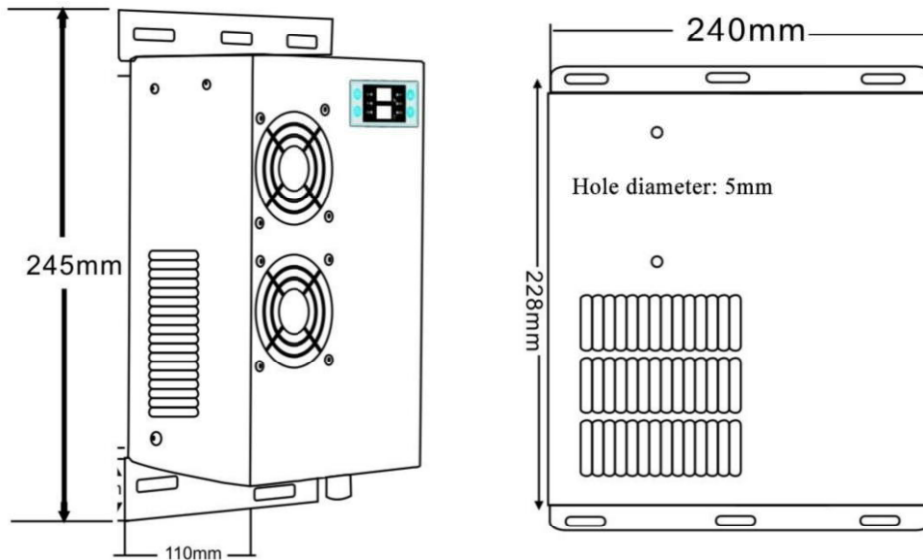

Dimension: 240X245X68mm

Notes:

1. Fix with M5 screws or 5mm rivets. When installing, the dehumidifier must be placed vertically with the water outlet facing down.
2. Ensure that there is more than 5cm of space between the front of the dehumidifier and other devices to ensure the air from the front fan outlet.
3. One end of the outlet pipe is connected to the drain of the dehumidification device, fixed with a clamp to keep the water pipe smooth and not entangled, and the other end leads to the outside of the box.
4. Connect the power terminal L/N to AC220V power supply.

4.2.- Connection terminal (see label on the Side part)

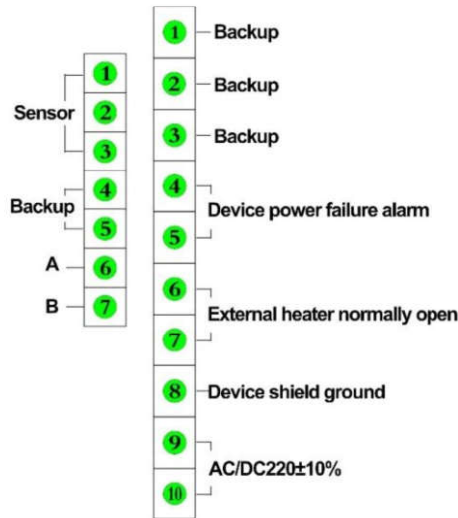

Left terminal

1-3: Sensor connection

4-5: Backup

6-7: Communication

Right terminal

1-3: Backup

4-5: Device power failure alarm NC

6-7: External heater NO





8: Device shield ground

9-10: Power supply

5. - OPERATION MODE

5.1.- Key description



Key	In Working state	In Setting state
 	/	Select parameters and set the values.
	Switch between Auto/Manual mode	Enter the parameter setting
	Enter setting screen	Save the modified value and exit the setting screen.

5.2.- Manual/ Auto mode switch

The device default in the Automatic state and the "Auto" indicator light is on. After pressing the " " key, the "Auto" indicator light is off, and the "Manual" indicator light is on. At this time, the dehumidifier module starts work.

Again pressing the " " key, the dehumidifier automatically turns to Auto mode.



Press multiple times the " " key to cycle through the Auto/Manual mode.

5.3.- Parameter setting procedure

After the power is turned on, the device enters the self-test program, and enters the Auto mode. the screen displays the current temperature and humidity values.

P1 075	P2 065	P3 005	P4 005	P5 -01	P6 000	P7 001
Dehumidification start threshold	Dehumidification stop threshold	Heater start threshold	Temperature HYS	Defrost start threshold	Working mode	Modbus address



Press the "  " to can set the P1-P7 parameter values (Dehumidification start threshold, Dehumidification stop threshold, Heater start threshold, Temperature HYS, Defrost start threshold ,Working mode ,Modbus address)

Press the "  " the lower row numbers will flash, Then press the "  " or "  " to select and modify the P1-P7 parameter value;

After the modification completed, press the "  " to save, the number stops flashing.

Notes:

1. Cooling stop temperature threshold: used to force the device to stop working under a specific temperature environment. Refrigeration stop threshold is based on 10, that is, 10 represents 0 degrees, stop cooling, 11 means +1 degrees, and 9 means -1 degrees.

2. For the correction value of the temperature measurement of the cooling chip, when the temperature and humidity are displayed on the normal startup screen, press the "  " or "  " synchronously to enter the setting flashing screen. The setting method is the same as above.

5.4.- Remote control (optional)

When the dehumidification device receives wireless data from the main control room, the communication indicator light will flash.

5.5.- RS485 communication (optional)

When the dehumidification device receives data from the host inquiry, the communication indicator light will flash. Please refer to [Chapter 6](#) for details.

6. - COMMUNICATION INTERFACE

This device adopts MODBUS- RTU communication protocol, RS-485 communication mode, baud rate 9600bps, 1 start bit, 8 data bits, no parity, 1 stop bit, that is, 1 byte of data in total 10 bits. The default setting address of the device is 01 when it leaves the factory, and the user can reset it according to the site conditions.

6.1.- MODBUS © protocol

Modbus RTU Frame Format:

Address code	1 BYTE	<i>Slave device address 1-247</i>
Function code	1 BYTE	<i>Indicates the function codes like read coils / inputs</i>
Data code	4 BYTE	<i>Starting address, high byte Starting address, low byte Number of registers, high byte Number of registers, low byte</i>
Error Check code	2 BYTE	<i>Cyclical Redundancy Check (CRC)</i>

MODBUS FUNCTIONS

Code	Meaning	Description
FUNCTION 03	Read holding register	<i>Read setting parameters</i>
FUNCTION 04	Read input registers	<i>Read setting parameters</i>
FUNCTION 06	Preset single register	<i>Set the device parameters</i>
FUNCTION 10	Preset multiple registers	<i>Set the device parameters</i>

6.2.- Command samples

6.2.1 - Query the temperature and humidity value, Read only, “03H” code to read

Host inquiry

Address	01H
Function code	03H
Starting register _H	00H
Starting register _L	00H
Inquiry length _H	00H
Inquiry length _L	06H
CRC_H	XXH
CRC_L	XXH

Slave response

Address	01H
Function code	03H
Data length	06H
Humidity _H	...
Humidity _L	...
Temperature _H	...
Temperature _L	...
Device status	(00: OFF,01:ON)
Heater status	
CRC_H	XXH
CRC_L	XXH

Example: Host inquiry

01 03 00 00 00 06 45 CA

Slave response

01 03 06 53 02 0D 01 00 00 BA 07

Note:

The last digit of the temperature and humidity indicates the decimal place, and the highest position of the 16-bit temperature value is 1, when the temperature is negative

For example: -10.1°C is expressed as 1000 0000 0110 0101

6.2.2 - Query setting parameters, Read only, "04H" code to read

Host inquiry

Address	01H
Function code	04H
Starting register_ H	00H
Starting register_ L	01H
Inquiry length_ H	00H
Inquiry length_ L	06H
CRC_ H	XXH
CRC_ L	XXH

Slave response

Address	01H
Function code	04H
Data length	06H
Humidity start threshold	...
Humidity stop threshold	...
Heater start threshold	...
Current dehumidification status	...
Heater status	(00: OFF,01:ON)
Backup	
CRC_ H	XXH
CRC_ L	XXH

Example: Host inquiry

01 04 00 01 00 06 C8 21

Slave response

01 04 06 41 2D 05 01 01 88 92 00

6.2.3 - Change device parameters, Write only, “10H” code to write

Host inquiry

Address	01H
Function code	10H
Starting register_ H	00H
Starting register _L	00H
Inquiry length_ H	00H
Inquiry length_ L	06H
Humidity start threshold	...
Humidity stop threshold	...
Heater start threshold	...
Current dehumidification status	No such function, fill in 0A
Heater status	No such function, fill in 0A
Backup	No such function, fill in 0A
CRC_H	
CRC_L	

Slave response

Address	01H
Function code	10H
Humidity_ H	...
Humidity _L	...
Data length	06H
CRC_H	XXH
CRC_L	XXH

Example: Host inquiry

01 10 00 00 00 06 06 40 2A 05 0A 0A 0A D0 97

Slave response

01 10 00 00 00 06 06 F2 8A

Means that:

Humidity start threshold is set to: 64%RH

Humidity stop threshold is set to: 42%RH

Heater start threshold is set to: 5°C

Note:

The backup register must be filled with **0X0A**, otherwise it may cause device failure.

6.2.4 - Set manual dehumidification/auto dehumidification, Write only, “06H” code to write

Host inquiry

Address	01H
Function code	06H
Register address	00H
Set value _H	01H
Set value _L	00H
	01: Manual dehumidification
	00: Auto dehumidification
CRC_H	XXH
CRC_L	XXH

Slave response

Address	01H
Function code	06H
Register address	00H
Set value _H	01H
Set value _L	00H
	01: Manual dehumidification
	00: Auto dehumidification
CRC_H	XXH
CRC_L	XXH

Example: Host inquiry

01 06 00 01 00 01 CA 19

Slave response

01 06 00 01 00 01 CA 19

Means that:

Set to manual dehumidification

7. - SAFETY CONSIDERATIONS



All installation specification described at the previous chapters named:
INSTALLATION AND STARTUP, INSTALLATION MODES and SPECIFICATIONS.

Please note that with the instrument powered on, the terminals could be dangerous to touching and cover opening actions or elements removal may allow accessing dangerous parts. This instrument is factory-shipped at proper operation condition.

- ◆ The device must have a professional installation and maintenance.
- ◆ Any operation of the device, you must cut off the input signal and power.

8. - TECHNICAL SERVICE

For any inquiry about the instrument performance or whether any failure happens, contact to Blue Jay's technical service.

Blue Jay - After-sales service

*1802, Building 2, No.88, Jianxin East Road,
Chongqing,400020, China*

*Tel - + 0086 023 67628702
E-mail: tech@cqbluejay.com*