

# DH6-200

## Peltier Cooling Dehumidifier

### User Manual



**Version:1.13**

**Revision: 2026.03**

## Read me

**When you use DH6-200 Peltier Cooling Dehumidifier, be sure to read this user manual carefully, and be able to fully understand the implications, the correct guidance of operations in accordance with user manual, which will help you make better use of DH6-200 Peltier Cooling Dehumidifier and help to solve the various problems on the site.**

1. Always keep safe distance between the high voltage part and the instrument, probe and operator.
2. Measurements must not be taken when thunderstorms are nearby.
3. Do not operate the instrument or accessories in explosive atmospheres.
4. After the battery alarm of the instrument, please turn off the power to charge.
5. Do not open the instrument without permission, this will affect the warranty of the product. The factory is not responsible for self-disassembly.
6. When the instrument is transported, it should avoid rain erosion and prevent collision and falling.
7. When storing and keeping the instrument, attention should be paid to the ambient temperature and humidity, and it should be protected from dust, moisture, shock, acid, and corrosive gas.



- **Please read this user manual carefully**
- **Please save this document**

## Directory

<b>1.- SUMMARIZE .....</b>	<b>- 1 -</b>
<b>2.- FUNCTION INTRODUCTION .....</b>	<b>- 2 -</b>
2.1.- DEHUMIDIFICATION PRINCIPLE.....	- 2 -
2.2.- HEATING FUNCTION (OPTIONAL).....	- 2 -
2.3.- RS485 COMMUNICATION FUNCTION (OPTIONAL).....	- 3 -
2.4.- ALARM DIGITAL OUTPUT (OPTIONAL).....	- 3 -
<b>3.- TECHNICAL SPECIFICATION .....</b>	<b>- 4 -</b>
<b>4.- INSTALLATION AND START-UP .....</b>	<b>- 5 -</b>
4.1.- WALL-MOUNTED INSTALLATION DIMENSION (UNIT: MM).....	- 5 -
4.2.- CONNECTION TERMINAL AND WIRING METHOD.....	- 6 -
<b>5.- OPERATION MODE .....</b>	<b>- 7 -</b>
5.1.- KEY DESCRIPTION.....	- 7 -
5.2.- MANUAL/ AUTO MODE SWITCH.....	- 7 -
5.3.- PARAMETER SETTING PROCEDURE.....	- 8 -
<b>6.- COMMUNICATION INTERFACE .....</b>	<b>- 9 -</b>
6.1.- MODBUS © PROTOCOL.....	- 9 -
6.2.- COMMAND SAMPLES.....	- 10 -
6.3.- REGISTER MAP.....	- 14 -
<b>7.- SAFETY CONSIDERATIONS .....</b>	<b>- 15 -</b>
<b>8.- TECHNICAL SERVICE .....</b>	<b>- 15 -</b>

## 1.- SUMMARIZE

The intelligent dehumidification device adopts the semiconductor refrigeration dehumidification method, actively drawn the humid air in the confined space into the dehumidification duct under the action of the fan, and the water vapor in the air is condensed into water after passing through the semiconductor refrigeration mechanism, and then discharged out of the cabinet through the water pipe body, can achieve a good dehumidification effect.

By reducing the water content in the air, the relative humidity and absolute humidity are reduced at the same time, the temperature is hardly raised, and there will be no negative impact caused by the temperature difference, which fundamentally eliminates or reduces the occurrence of accidents, and will not accelerate the cabinet due to high temperature. Aging of internal components and cabinets. Effectively prevent safety hazards such as aging of equipment in the cabinet, reduction of insulation strength, breakdown of secondary terminals, mildew of materials and corrosion of steel structural parts, and ensure the safe operation of the power grid.

### FEATURES

- Thermoelectric Peltier cooling principle;
- Compact and lightweight, easy installation;
- Low power (20–200 W) and high efficiency;
- Adjustable humidity and temperature control;
- Optional 50–500 W external heater connection;
- Auto/manual mode, adjustable thresholds;
- 24h real-time temp/humidity monitoring;
- Optional RS485/ Modbus RTU for remote control;
- Moisture-proof components, reliable in humidity;

### APPLICATIONS

- Power substation equipment rooms;
- Relay protection & control panels;
- Switchgear & transformer chambers;
- Data centers & telecom center;
- Distribution & control cabinets;
- Relay testing & maintenance rooms;
- Power Control & monitoring centers;

## 2.- FUNCTION INTRODUCTION

### 2.1.- Dehumidification principle

The intelligent dehumidification device consists of a power supply, an air supply system, a thermoelectric (Peltier) cooler, a temperature and humidity control circuit, a heating circuit, and a drain hose.

Moist air is drawn into the unit by a fan and passes over the Peltier cooler. The cold side condenses moisture from the air, while the hot side dissipates heat. Condensed water collects on the cold surface and drains through the hose. The fan then delivers dehumidified air through the outlet.

An MCU controls the system, continuously monitoring temperature and humidity via sensors and managing the heater, alarms, and communication interfaces to ensure stable operation.

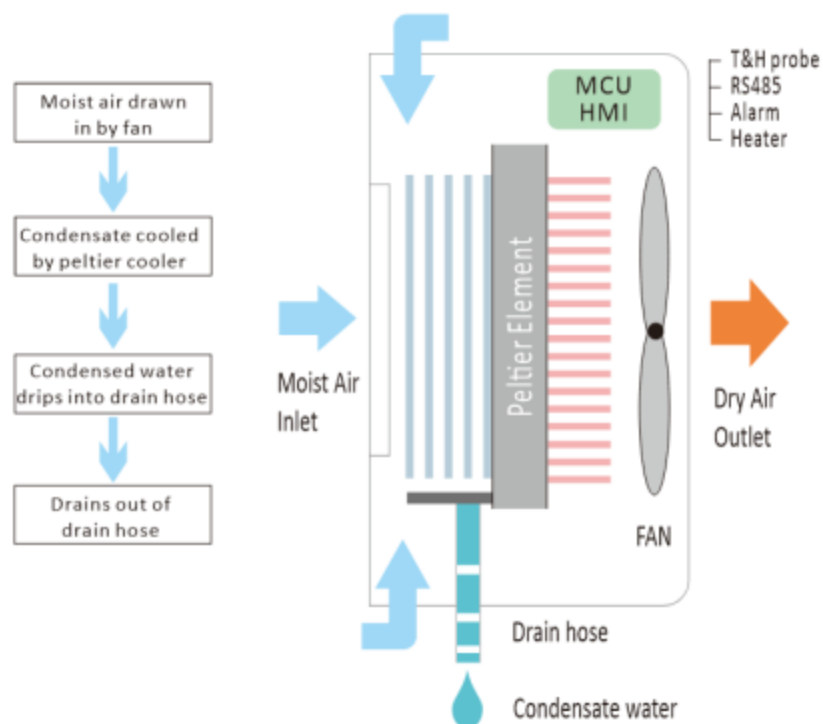

### 2.2.- Heating function (optional)

When the temperature of the box is lower than the set start threshold, Default 5°C, the dehumidification device starts the internal heater circuit (the heater is connected externally, and the power can be connected to 50-500W), until the temperature of the box rises to the set start threshold, the heater circuit stops working.

### **2.3.- RS485 communication function (optional)**

When equipped with RS485, the dehumidifier communicates with the host computer by receiving and responding to data packets. A single host can connect up to 28 units (a 120  $\Omega$  termination resistor between A and B is recommended), with a max communication distance of 1000 meters. Each unit has a configurable communication address. The interface supports remote control, parameter adjustment, and fault reporting.

### **2.4.- Alarm digital output (optional)**

The dehumidifier provides a single-channel alarm digital output (DO) to indicate abnormal conditions, including sensor disconnection, power failure, and temperature or humidity exceeding preset limits.

Upon any abnormal event, the DO output triggers immediately, enabling external monitoring or integration with control systems for rapid response. The output default passive dry contact, normally closed under normal operation and opens when a fault occurs.

### 3.- TECHNICAL SPECIFICATION

#### Working power

Power supply	85V~265VAC/DC 50Hz
Peltier rated power	200W
Air volume flow	140m <sup>3</sup> /h
Dehumidifying capacity	600ml/Day, @35°C,90%RH

#### Measurement and ability

Humidity monitor range	20%RH~95%RH
Sensor accuracy	±5%RH
Dehumidify start threshold	1%RH~99%RH, Default 75%RH
Environment temperature	5~60°C
Temperature monitor range	-40~80°C
Sensor accuracy	±1.0°C
Heater start threshold	1~55°C, Default 5°C
Heater power	50~500W optional
Relay contact capacity	For heater: Dry contact, NO, 5A@250Vac/ 30Vdc For fault alarm: Dry contact, NC, 3A@250Vac/ 30Vdc

#### Other

Drain hose	Silicone, OD 10 mm, ID 8 mm, length 2/3m optional
Dimension	240X245X68mm
Material	Sheet metal with anti-rust spray
Screen	2*3 digital LED
Standards	IEC60255-22-1
Communication	RS485, Modbus-RTU (Optional)

## 4.- INSTALLATION AND START-UP

### 4.1.- Wall-mounted installation dimension (unit: mm)

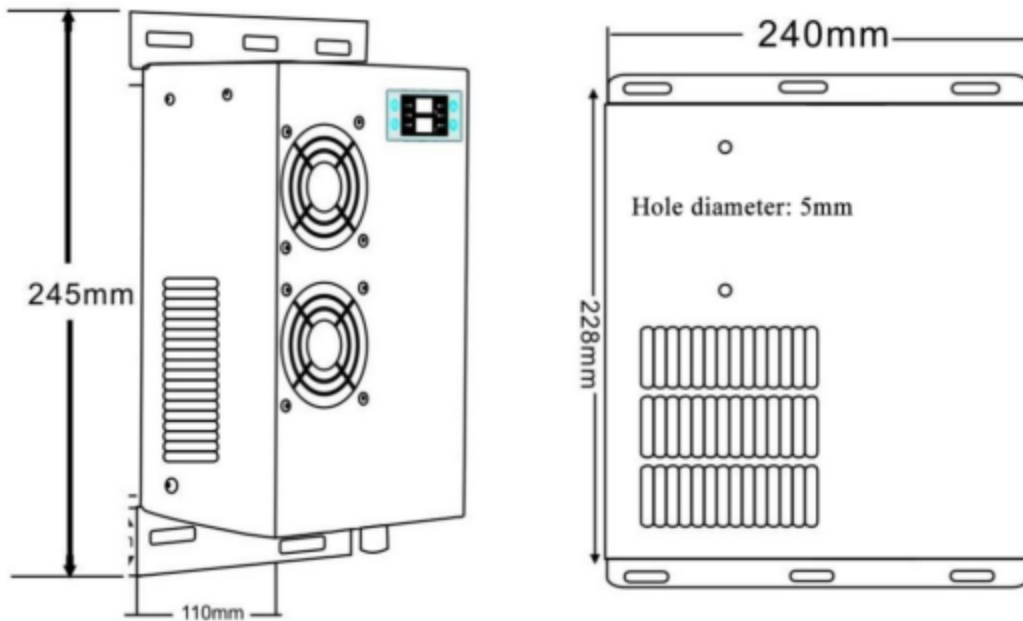

Dimension: 240X245X68mm

#### Notes:

1. Fix with M5 screws or 5mm rivets. When installing, the dehumidifier must be placed vertically with the water outlet facing down.
2. Ensure that there is more than 5cm of space between the front of the dehumidifier and other devices to ensure the air from the front fan outlet.
3. One end of the outlet pipe is connected to the drain of the dehumidification device, fixed with a clamp to keep the water pipe smooth and not entangled, and the other end leads to the outside of the box.
4. Connect the power terminal L/N to AC220V power supply.

### 4.2.- Connection terminal and wiring method

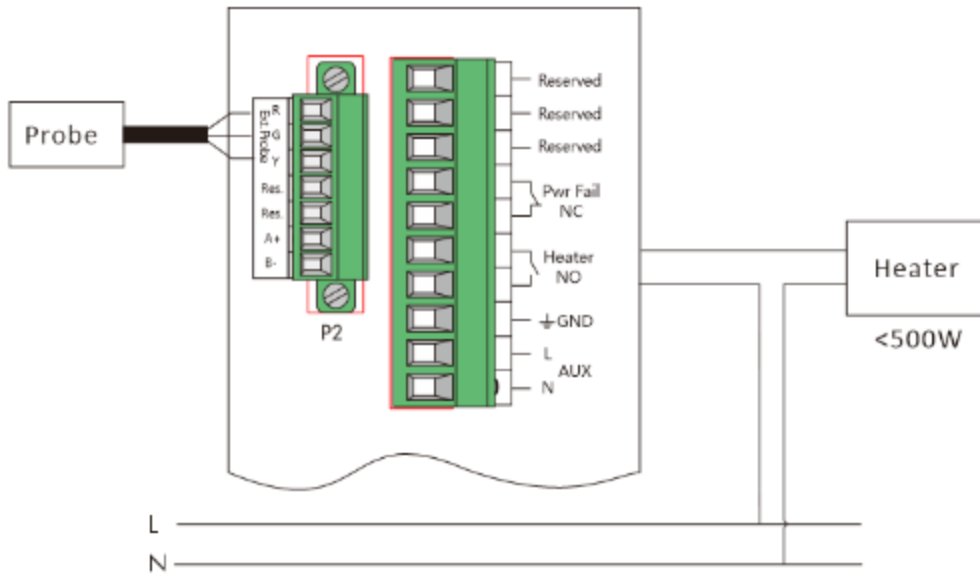

**Default passive dry node, heater need additional power supply.**

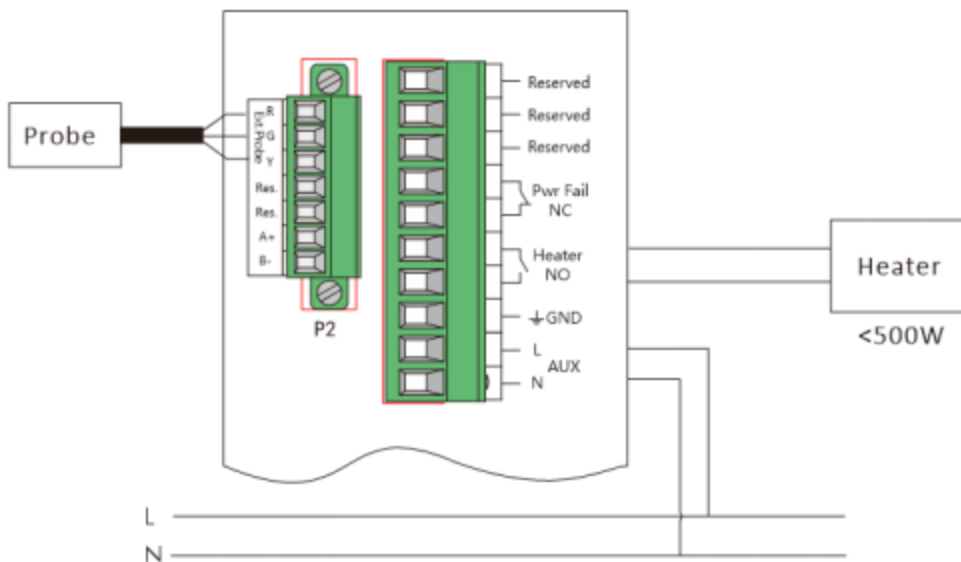





**Optional active wet node version, heater can be powered by the dehumidifier.**

Left terminal	Right terminal
1-3: Sensor connection	1-3: Reserve
4-5: Reserve	4-5: Device power failure alarm (NC)
6-7: Communication port	6-7: External heater normally open
	8: Device shield ground
	9-10: Power supply

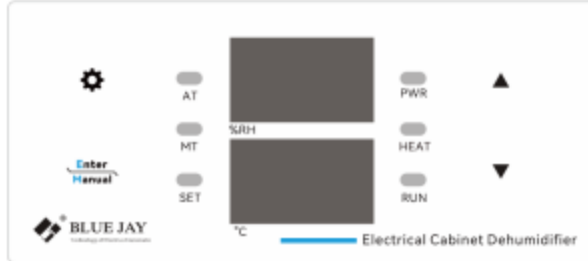
## 5.- OPERATION MODE

### 5.1.- Key description



Key	In Working state	In Setting state
	/	Select parameters and set the values.
	Switch between Auto/Manual mode	Enter the parameter setting
	Enter setting screen	Save the modified value and exit the setting screen.

### 5.2.- Manual/ Auto mode switch

The device default in the automatic mode and the "AT (auto)" indicator light is on. After pressing the " " key, the "AT" indicator light is off, and the "MT (manual)" indicator light is on, the dehumidifier module switch to manual mode.

Pressing the " " key again, the dehumidifier automatically turns to auto mode.



Press multiple times the " " key to cycle through the auto/ manual mode.

### 5.3.- Parameter setting procedure

After the power is turned on, the device enters the self-test program, and enters the Auto mode. The screen displays the current temperature and humidity values.



P1 075	P2 065	P3 005	P4 005	P5 -01	P6 000	P7 001
Dehumidification start threshold	Dehumidification stop threshold	Heater start threshold	Temperature HYS	Defrost start threshold	Working mode	Modbus address

Press the "  " to can set the P1-P7 parameter values (Dehumidification start threshold, Dehumidification stop threshold, Heater start threshold, Temperature HYS, Defrost start threshold ,Working mode ,Modbus address)

Press the "  " the lower row numbers will flash, Then press the "  " or "  " to select and modify the P1-P7 parameter value;

After the modification completed, press the "" to save, the number stops flashing.

**Notes:**

1. Cooling stop temperature threshold: used to force the device to stop working under a specific temperature environment. Refrigeration stop threshold is based on 10, that is, 10 represents 0 degrees, stop cooling, 11 means +1 degrees, and 9 means -1 degrees.
2. For the correction value of the temperature measurement of the cooling chip, when the temperature and humidity are displayed on the normal startup screen, press the "  " or "  " synchronously to enter the setting flashing screen. The setting method is the same as above.

## 6.- COMMUNICATION INTERFACE

This device adopts RS485/ MODBUS RTU communication protocol, baud rate 9600bps, 1 start bit, 8 data bit, no parity, 1 stop bit, that is, 1 byte of data in total 10 bits. The factory default address is 01, user can reset it according to the site conditions.

### 6.1.- MODBUS © protocol

#### Modbus RTU Frame Format

<b>Address code</b>	<b>1 BYTE</b>	Slave device address <b>1-247</b>
<b>Function code</b>	<b>1 BYTE</b>	Indicates the function codes like read coils / inputs
<b>Data code</b>	<b>4 BYTE</b>	Starting address, high byte Starting address, low byte Number of registers, high byte Number of registers, low byte
<b>Error Check code</b>	<b>2 BYTE</b>	Cyclical Redundancy Check ( <b>CRC</b> )

#### MODBUS FUNCTIONS

<b>Code</b>	<b>Meaning</b>	<b>Description</b>
<b>FUNCTION 03</b>	<b>Read holding register</b>	Read setting parameters
<b>FUNCTION 04</b>	<b>Read input registers</b>	Read setting parameters
<b>FUNCTION 10</b>	<b>Write multiple registers</b>	Set the device parameters

## 6.2.- Command samples

### 6.2.1.- Query the temperature and humidity value, Read only, "03H" code to read

#### Host inquiry

Address	01H
Function code	03H
Starting register _H	00H
Starting register _L	07H
Inquiry length _H	00H
Inquiry length _L	03H
CRC _L	XXH
CRC _H	XXH

#### Slave response

Address	01H
Function code	03H
Data length	06H
Temperature _H	...
Temperature _L	...
Humidity _H	...
Humidity _L	...
Evaporator fin _H	...
Evaporator fin temperature value - L	...
CRC _L	XXH
CRC _H	XXH

#### Example: Host inquiry

01 03 00 07 00 03 B4 0A

#### Slave response

01 03 06 00 FA 02 58 00 00 BA 07

#### Note:

When the temperature is negative value, and the most significant bit (MSB) of the 16-bit temperature value is 1, using standard two's complement format.

For example: -10°C is expressed as 1111 1111 1111 0110

## 6.2.2.- Query setting value and working status, Read only, "04H" code to read

### Host inquiry

Address	01H
Function code	04H
Starting register_ H	00H
Starting register_ L	00H
Inquiry length_ H	00H
Inquiry length_ L	07H
CRC_ L	XXH
CRC_ H	XXH

### Slave response

Address	01H
Function code	04H
Data length	0EH
Working status	...
Working mode	...
Humidity start threshold_ H	...
Humidity start threshold_ L	...
Humidity stop threshold_ H	...
Humidity stop threshold_ L	...
Temperature start threshold_ H	...
Temperature start threshold_ L	...
Temperature HYS. threshold_ H	...
Temperature HYS. threshold_ L	...
Condenser fins threshold_ H	...
Condenser fins threshold_ L	...
Device communication address_ H	...
Device communication address_ L	...
CRC_ L	XXH
CRC_ H	XXH

### Example: Host inquiry

01 04 00 00 00 07 B1 C8

### Slave response

01 04 0E 00 00 00 4B 00 41 00 05 00 05 00 00 00 01 B9 51

Heating relay output status (01 means closed, 00 means normally open)

### 6.2.3.- Modify device parameters, Write only, “10H” code to write

#### Host inquiry

Address	01H
Function code	10H
Starting register	00H
	01H
Register NO.	00H
	06H
Inquiry length	0C
Humidity start threshold	0X004B
Humidity stop threshold	0X0041
Temperature start threshold	0X0005
Temperature HYS. threshold	0X0005
Condenser fins stop threshold	0x0001
Device address	0x0001
CRC_L	XXH
CRC_H	XXH

#### Example: Host inquiry

01 10 00 01 00 06 0C 00 4B 00 41 00 05 00 05 00 01 00 01 8E F1

#### Slave response

01 10 00 01 00 06 11 CB

#### Means that:

Humidity start threshold is set to: 75%RH

Humidity stop threshold is set to: 65%RH

Temperature start threshold is set to: 5°C

**6.2.4.- Set manual/ auto dehumidification, Write only, “10H” code to write****Host inquiry**

Address	01H
Function code	10H
Starting register	00H
	07H
Register NO.	00H
	01H
Inquiry length	02H
Manual switch command byte	0XAA55
CRC_L	XXH
CRC_H	XXH

**Example: Host inquiry**

01 10 00 07 00 01 02 AA 55 19 78

**Slave response**

01 10 00 07 00 01 B0 08

**Means that:**

Manual/ automatic dehumidification switch command

**Note:**

Register 0007 is a multiplexed register: reading returns the ambient temperature value, writing sends manual or automatic dehumidification control commands.

### 6.3.- Register map

Register	Item	Byte	Description
0000	Working mode/ display mode	2	<p><b>The lower 8 bits indicate the working mode:</b>                      0 = Heating working mode;                      1 = Cooling working mode.</p> <p><b>The upper 8 bits indicate the working status:</b>                      0 = Automatic status;                      1 = Manual status;                      2 = Setting status;                      3 = Running status;                      4 = Dehumidifier working status;                      5 = Heater working status;                      6 = Fan working status;                      7 = Deicing working status</p> <p>Default: 0,0</p>
0001	Dehumidification start threshold	2	Range: 0 ~ +99.0%RH, default: 75%
0002	Dehumidification stop threshold	2	Range: 0 ~ +99.0%RH, default: 65%
0003	Temperature start threshold	2	Range: 0.0°C ~ 99.9°C, default: 5.0°C
0004	Temperature HYS. threshold	2	Range: 0°C ~ 20°C, default: 0.0°C
0005	Condenser fins threshold	2	Range: -9°C ~ +9°C, default: 0.0°C
0006	Device communication address	2	Range: 1~247, default: 1
0007	Ambient temperature value	2	Range: 0°C ~+99.9°C
0008	Ambient humidity value	2	Range: 0 ~ +99.0% RH
0009	Evaporator fin temperature value	2	Range: -50°C ~ +99.9°C

**Note:**

The data in register 0000 ~ 0008 involve decimal points, so the data must be multiplied by 10 or divided by 10 to get the actual data of the decimal point.

## 7.- SAFETY CONSIDERATIONS



All installation specification described at the previous chapters named:  
**INSTALLATION AND STARTUP, INSTALLATION MODES and SPECIFICATIONS.**

Please note that with the instrument powered on, the terminals could be dangerous to touching and cover opening actions or elements removal may allow accessing dangerous parts. This instrument is factory-shipped at proper operation condition.

- ◆ The device must have a professional installation and maintenance.
- ◆ Any operation of the device, you must cut off the input signal and power.

## 8.- TECHNICAL SERVICE

For any inquiry about the instrument performance or whether any failure happens, contact to Blue Jay's technical service.

*Blue Jay - After-sales service*

*1802, Building 2, No.88, Jianxin East Road,  
Chongqing,400020, China*

*Tel - + 0086 023 67628702  
E-mail: tech@cqbluejay.com*