

# MCM400 Multi-Channel Circuit Metering System

## User Manual



Version: 1.31

Revision 2026.04

## Read me

**When you use MCM400 series Multi-Channel Circuit Metering system, be sure to carefully read this user manual, and be able to fully understand the implications, the correct guidance of operations in accordance with user manual, which will help you make better use this AC Energy Meter, and help to solve the various problems at the scene.**

1. Before the meter turning on the power supply, be sure that the power supply within the provisions of the instrument;
2. When installation, the current input terminal must non-open, voltage input terminals must Non-short circuit;
3. Be sure the instrument wiring consistent with the internal system settings;
4. When communicating with the PC, instrument communication parameters must be consistent with the PC



- **Please read this user manual carefully**
- **Please save this document**

# Directory

<b>CONTENTS</b>	<b>Page</b>
<b>1. - SUMMARIZE .....</b>	<b>- 4 -</b>
<b>2. - SPECIFICATIONS .....</b>	<b>- 5 -</b>
<b>3.- INSTALLATION AND START-UP .....</b>	<b>- 7 -</b>
3.1.- INSTALLATION .....	- 7 -
3.2. - CONNECTION TERMINAL OF MCM400 .....	- 8 -
<b>4. - SETUP PROCEDURE .....</b>	<b>- 9 -</b>
4.1. - KEY OPERATION .....	- 9 -
4.2. - SHOW ELECTRIC PARAMETERS .....	- 9 -
4.3.- PARAMETERS SETTING .....	- 11 -
4.4. - MENU STRUCTURE .....	- 12 -
<b>5. - COMMUNICATION PROTOCOL .....</b>	<b>- 13 -</b>
5.1. - CONNECTION FOR THE RS485 BUS .....	- 13 -
5.2. - MODBUS © PROTOCOL .....	- 14 -
5.3. - REGISTER ADDRESS TABLE .....	- 15 -
<b>6. - SAFETY CONSIDERATIONS .....</b>	<b>- 18 -</b>
<b>7. - MAINTENANCE .....</b>	<b>- 18 -</b>
<b>8. - TECHNICAL SERVICE .....</b>	<b>- 18 -</b>

## 1. - SUMMARIZE

The MCM400 Series provides a compact and robust metering solution, enable reliable monitoring of building electrical loads with a low installation cost-per-point by combining sub-metering. The unit performs real-time metering, measures energy consumption of 4 channels circuits for three phase circuits.

Advanced communications options including Modbus via RS485, I/O communications provide for extensive reliable data exchange. Multiple units can be connected together to meter unlimited number of circuits. The versatility of MCM400 meters are ideal for multi-tenant or departmental metering applications within office towers, condominiums, apartment buildings, shopping centers and other multi-user environments.

### Measurement Function

**Voltage:** Line Voltage; Phase Voltage

**Current:** Total Current; Current per channel

**Power and Power Factor:** Total power Reactive Power, Apparent Power, Power Factor and for per channel

**Frequency:** System Frequency

### Energy Function

Energy (kWh) measurement meeting international standards, accuracy is Class 1.0. It optional Time of Use feature: 12 Seasons, 4 Tariffs record, max three-month data for each channel.

### Over/Under Limit Alarming

Users can select parameters and set their set points. An alarm will be triggered when the setpoint is reached, user can get the info from MODBUS reading.

### Power Quality Analysis

Optional power quality parameters such as voltage and current THD, Odd harmonic distortion (Total Odd HD), even harmonic distortion (Total Even HD), 2 ~ 21 times the harmonic content, Current K-factor (KF), crest factor (CF), telephone interference factor (THFF), voltage and current unbalance etc.

### Communication and Network

Supports RS485 communication open protocol: Modbus RTU;

## 2. - SPECIFICATIONS

### Reference standard:

Basic electricity: IEC 61557-12:2007

Active energy: IEC 62053-21:2003

Reactive energy: IEC 62053-23:2003

### Accuracy standards

Parameter	Accuracy	A phase	B phase	C phase	All
Voltage	0.2	V1	V2	V3	
Current	0.2	A1	A2	A3	
Active Power	0.5	W1	W2	W3	W
Reactive Power	0.5	var1	var2	var3	var
Apparent power	0.5	VA1	VA2	VA3	VA
Power Factor	0.5	PF1	PF2	PF3	PF
Active Energy	1				Wh
Reactive Energy	2				varh
Frequency	0.1				Hz

**Notes:** final metering accuracy depends on sampling CT and PT accuracy

### Input

Voltage: Rated 100~220V (need confirm before order)

Current: Rated ..100mA (optional ..0.333V, need confirm before order)

Frequency: 45-65Hz

### Overload

Current: 1.2 times rated continuous; 5 seconds for 10 times the rated

Voltage: 1 seconds for 2 times the rated

### Dielectric strength

IEC/EN 61010-1:2010

2kV AC RMS 1 minute, between input / output / case / power supply

### EMC Test

	standard	Test voltage
Electrostatic discharge immunity test:	IEC-61000-4-2 level 4	8Kv
Electrical fast transient burst immunity test	IEC61000-4-4 level 3	Input 1kV; Power supply 2kV
Surge (Shock) immunity test	IEC61000-4-5 level 4	common mode test voltage 4kV

### Work environment

Temperature: -15C~ +55C

Humidity: RH 20%~95% (No condensation)

### Storage Conditions

Temperature: -30C~+70C

Humidity: RH 20%~95%

### Working Power

AC/DC 85-265V, 45-65Hz

DC 20-60V (Optional)

Maximum power consumption 3W

### Dimensions

L x H x D =87.3X132X46.5mm (with wiring terminal)

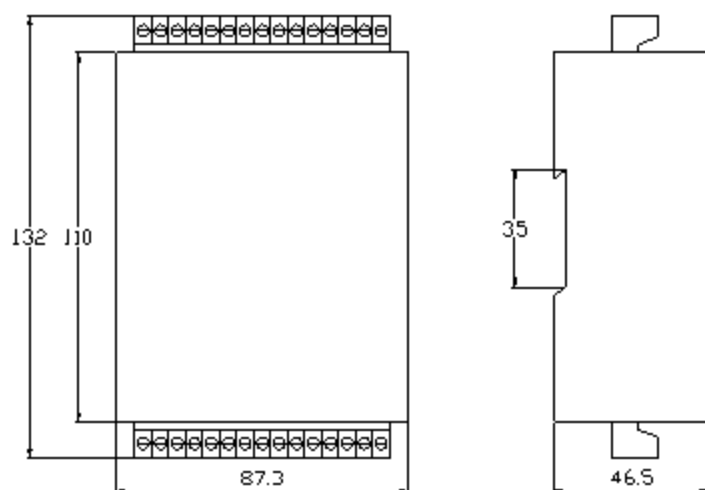

## 3.- INSTALLATION AND START-UP



The manual you hold in your hands contains information and warnings that the user should respect in order to guarantee a proper operation of all the instrument functions and keep its safety conditions. The instrument must not be powered and used until its definitive assembly is on the cabinet's door.

**Whether the instrument is not used as manufacturer's specifications, the protection of the instrument can be damaged.**

When any protection failure is suspected to exist (for example, it presents external visible damages), the instrument must be immediately powered off. In this case contact a qualified service representative.

### 3.1.- Installation

#### Mounting

Instrument is to be mounted on 35mm Din-rail. Keep all connections inside the cabinet.

Note that with the instrument powered on, the terminals could be dangerous to touch and cover opening actions or elements removal may allow accessing dangerous parts. Therefore, the instrument must not be used until this is completely installed.

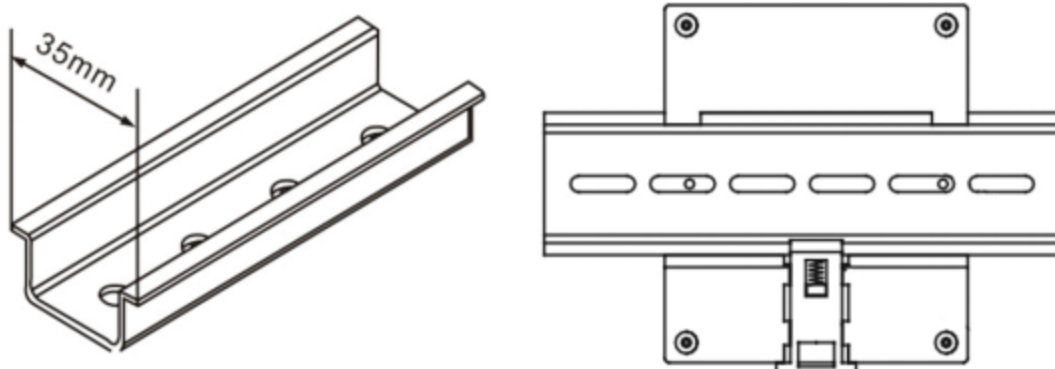

#### Notes:

##### Auxiliary power:

MCM400 meter with AUX power input, if not for a special statement, we provide the 85-265VAC/DC power interface for standard products. Please ensure that the auxiliary power match meter access to prevent damage to the product.

### 3.2. - Connection terminal of MCM400

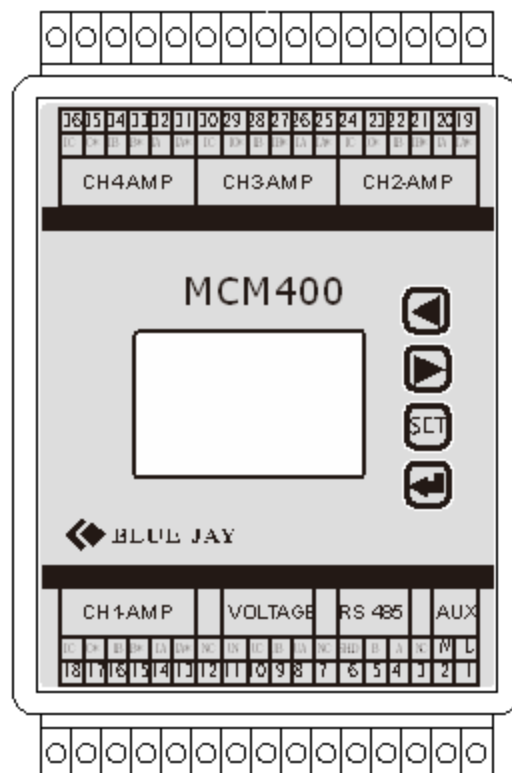

**Notes:**

The current input pin need to access the CT, and output signal of CT is 0-100mA or 0~0.333V, please confirm your ordering meter types and prepare related CT.



Wiring diagram may be changed due to the special requirements of customers order, please refer the label on the rear part.

If you are or sure or signs unclear please contact:

Blue Jay Technical Support: [tech@cqbluejay.com](mailto:tech@cqbluejay.com)

## 4. - SETUP PROCEDURE

### 4.1. - Key operation

“” or “” for screen switch or value increase/decrease

“**SET**” for menu enters or exit

“” for enter next menu or confirm the change



### 4.2. - Show electric parameters

When the MCM400 in monitor screen, user can use keypad switch shows the electrical parameters,

press “” to switch another screen in this channel,

press “” to switch another channel parameter

press “” to switch more details parameter in screen

screen roller logic as following:

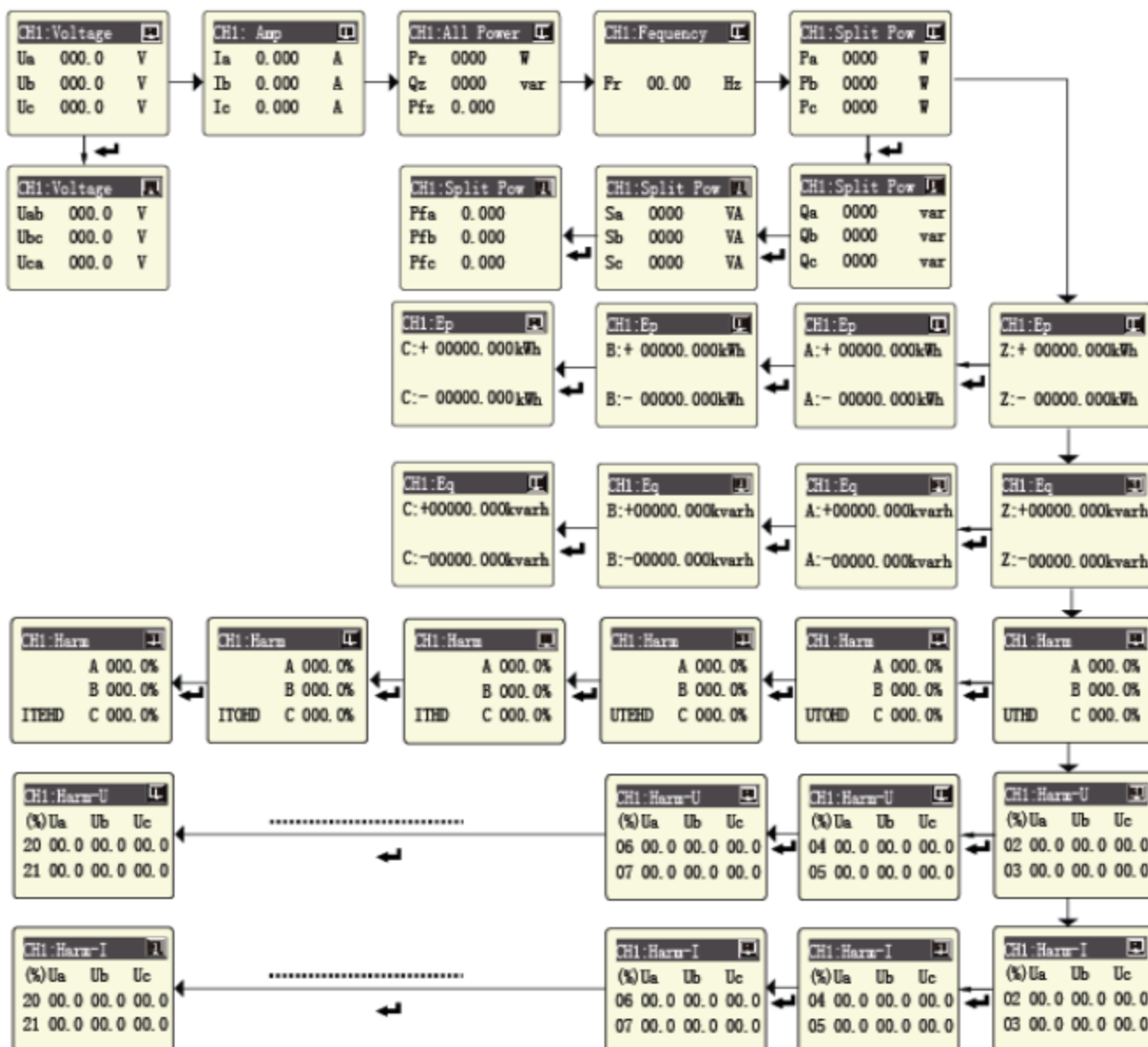

Note:

Energy data is displayed in 8-digit decimal format by default.

As counter increased, the decimal point position will move right, data increased by 10 times, the unit display changing from KWh to MWh.

### 4.3.- Parameters Setting

The SETUP procedure of the MCM400 is performed by means of several SETUP options. When into the SETUP, use the keyboard to select different options and enter required variables:

Press the key **SET** can enter the parameter setting. the screen ask access password (Default is 0001), then press **←** can enter the menu.

The operation menu logic as following:

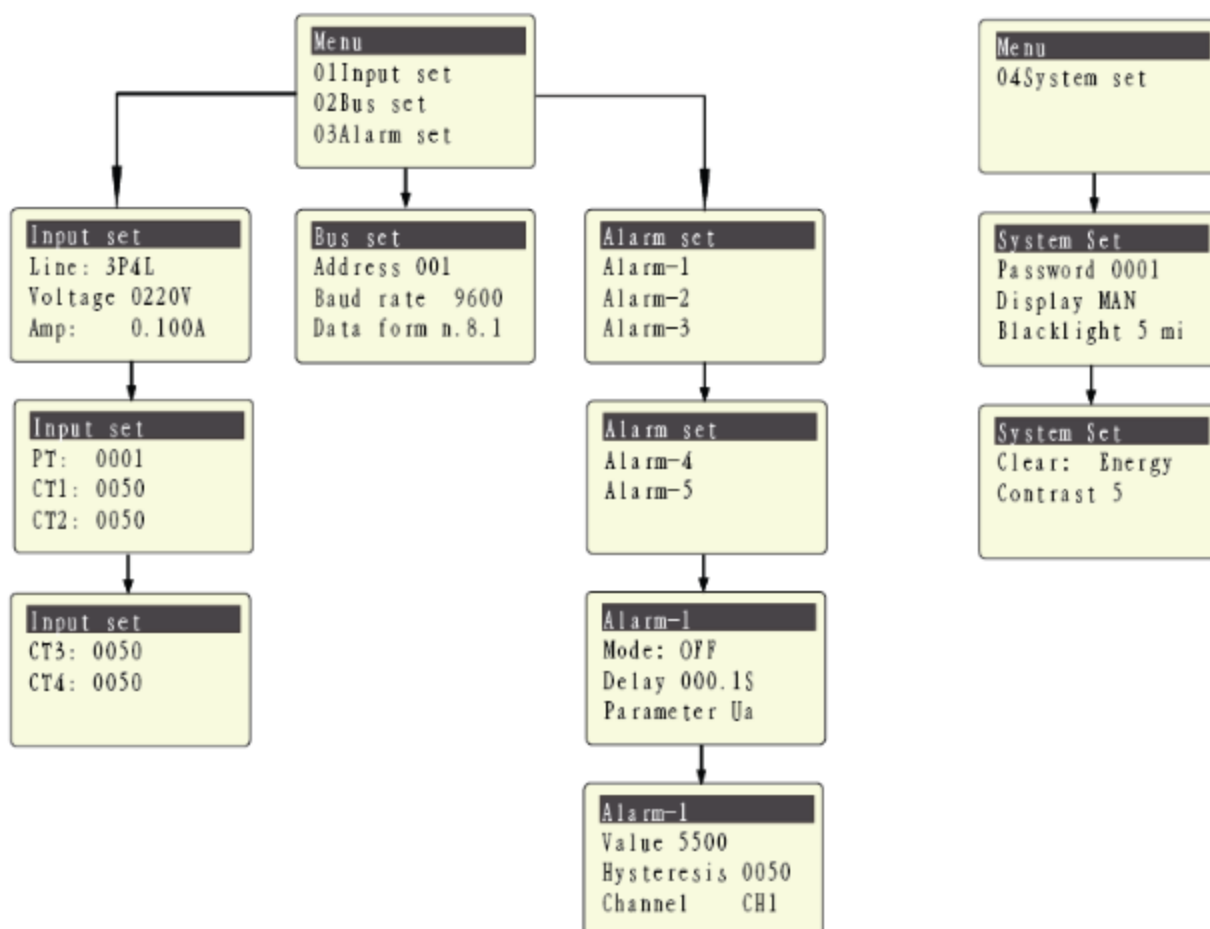

Notes:

1. **Clear energy:** Customers can write commands through RS485 or through the screen to clear the energy data to 0. Once the secondary side value of the internal memory reaches to  $2^{32}$ (4294,967,296), counter automatically reset to 0.

2. **Clear energy:** write command **0x0A0A** to register address **3000**

#### 4.4. - Menu Structure

level 1	Level 2	Level 3	Level 4	Description
Input Setting	Wiring mode	3P4L/3P3L2CT/3P3L3CT		input signal network measurement
	Rated volt	220V		Default setting, cannot be modified
	Rated amp	0.100A(100mA)		Default setting, cannot be modified
	PT ratio	Last time set value	1~9999	Default 0001
	CT ratio of CH1	Last time set value	1~9999	Default 0050
	CT ratio of CH2	Last time set value	1~9999	Default 0050
	CT ratio of CH3	Last time set value	1~9999	Default 0050
	CT ratio of CH4	Last time set value	1~9999	Default 0050
Comm Setting	Address	1~247	/	Default 0001
	Baud Rate	2400 / 4800 / 9600	/	Default is 9600
	Check format	n.8.1 / o.8.1 / e.8.1	/	Factory default ( <b>n.8.1</b> )
Alarm Setting	Alarm_1~5	Mode	OFF / Upper Limit / Lower Limit	Total three mode
		Delay	/	Alarm triggered time delay, Default 001.0s
		Parameter	Ua/Ub/Uc/Uab/Ubc...	Alarm triggered parameters
		Value	0~9999	Default is 5500,value related to secondary side parameters, unit: Volte - 0.1V; Amp - 0.001A; Active power - 0.1W; Reactive power - 0.1VAR; Power factor - 0.001; Frequency - 0.01HZ;
		hysteresis	0~9999	Default is 0050
		Related channel	CH1-4	Default CH1
System Settings	Password	0~9999	/	Reset user password
	Display	MAN Number 1~9	/	Manual switching, or automatic switching in 1~9sec
	Backlight	1~5	/	LCD backlight duration, unit is min, default is 5
	Clear	Energy	/	Clear the record in meter
	Contrast	1~9	/	LCD display contrast, default is 5

## 5. - COMMUNICATION PROTOCOL

### 5.1. - Connection for the RS485 BUS

The composition of the RS-485 cabling must be carried out with a meshed screen cable (minimum 3 wire), diameter of not less than 0.5mm<sup>2</sup>, with a maximum distance of 1,200 m between the BJ194... and the master unit. This Bus may connect a maximum of 32 BJ194...

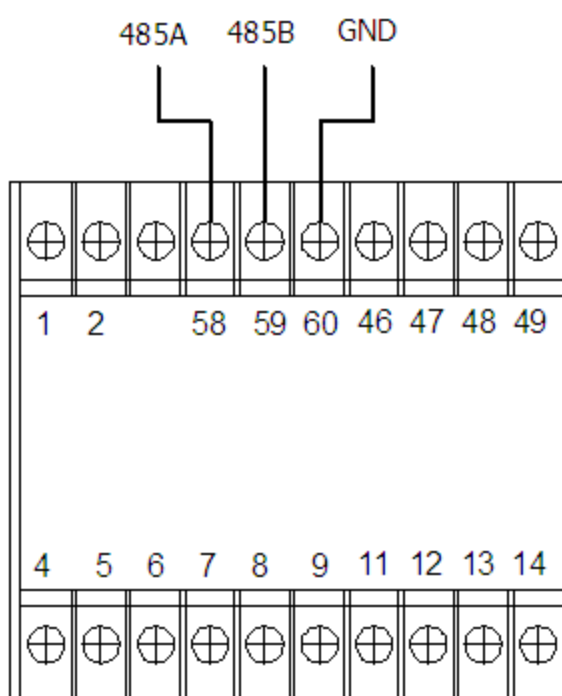

**Note:**

1. For communication with the master unit, customers can choose the RS-232 to RS-485 converter to use
2. Full range of BJ-... meter RS485 PIN number is 58,59,60
3. Due to product modifications or custom requirements, the interface pin place may be changed. For details, please refer to product label on the rear board

## 5.2. - MODBUS © protocol

### Modbus RTU Frame Format:

<b>Address code</b>	<b>1 BYTE</b>	<i>Slave device address 1-247</i>
<b>Function code</b>	<b>1 BYTE</b>	<i>Indicates the function codes like read coils / inputs</i>
<b>Data code</b>	<b>4 BYTE</b>	<i>Starting address, high byte Starting address, low byte Number of registers, high byte Number of registers, low byte</i>
<b>Error Check code</b>	<b>2 BYTE</b>	<i>Cyclical Redundancy Check (CRC)</i>

:

### MODBUS FUNCTIONS

<b>Code:</b>	<b>Meaning:</b>	<b>Description:</b>
<b>FUNCTION 03/04</b>	Reading of n Words	<i>This function permits to read all the electrical parameters of the BJ...series.</i>
<b>FUNCTION 06</b>	Write register	<i>Write value in to the relevant register</i>

**Note:** Float data follow **IEEE754**, float low bit first, high bit next. **(CD AB)**

### 5.3. - Register Address Table

#### 5.3.1- Basic Power Data—Primary Side

Address	Data	Byte mode		Instruction
0	CH1_Ua	float	2	Channel_1 Phase to Line Voltage, Unit: V
2	CH1_Ub	float	2	
4	CH1_Uc	float	2	
6	CH1_Uab	float	2	Channel_1 Phase to Phase Voltage, Unit: V
8	CH1_Ubc	float	2	
10	CH1_Uca	float	2	
12	CH1_Ia	float	2	Channel_1 Three phase Current, Unit: A
14	CH1_Ib	float	2	
16	CH1_Ic	float	2	
18	CH1_Pa	float	2	Channel_1 Individual phase active power, Unit: kW
20	CH1_Pb	float	2	
22	CH1_Pc	float	2	
24	CH1_PΣ	float	2	Channel_1 Total active power, Unit: kW
26	CH1_Qa	float	2	Channel_1 Individual phase reactive power, Unit: kVar
28	CH1_Qb	float	2	
30	CH1_Qc	float	2	
32	CH1_QΣ	float	2	Channel_1 Total reactive power, Unit: kVar
34	CH1_Sa	float	2	Channel_1 Individual apparent power, Unit: kVA
36	CH1_Sb	float	2	
38	CH1_Sc	float	2	
40	CH1_SΣ	float	2	Channel_1 Total apparent power, Unit: kVA
42	CH1_PFa	float	2	Channel_1 Individual power factor, 0~1.000
44	CH1_PFb	float	2	
46	CH1_PFc	float	2	
48	CH1_PFΣ	float	2	Channel_1 Total power factor, 0~1.000
50	CH1_FR	float	2	Channel_1 Frequency, Unit:0.01Hz
52	CH1_EpZ+	float	2	Channel_1 Total positive active energy, Unit: kWh
54	CH1_EpZ-	float	2	Channel_1 Total negative active energy, Unit: kWh
56	CH1_EqZ+	float	2	Channel_1 Total positive reactive energy, Unit: kVarh
58	CH1_EqZ-	float	2	Channel_1 Total negative reactive energy, Unit: kVarh
60	CH1_EpA+	float	2	Channel_1 A phase positive active energy, Unit: kWh
62	CH1_EpA-	float	2	Channel_1 A phase negative active energy, Unit: kWh
64	CH1_EqA+	float	2	Channel_1 A phase positive reactive energy,

				Unit: kVarh
66	CH1_EqA-	float	2	Channel_1 A phase negative reactive energy, Unit: kWh
68	CH1_EpB+	float	2	Channel_1 B phase positive active energy, Unit: kWh
70	CH1_EpB-	float	2	Channel_1 B phase negative active energy, Unit: kVarh
72	CH1_EqB+	float	2	Channel_1 B phase positive reactive energy, Unit: kVarh
74	CH1_EqB-	float	2	Channel_1 B phase negative reactive energy, Unit: kWh
76	CH1_EpC+	float	2	Channel_1 C phase positive active energy, Unit: kWh
78	CH1_EpC-	float	2	Channel_1 C phase negative active energy, Unit: kVarh
80	CH1_EqC+	float	2	Channel_1 C phase positive reactive energy, Unit: kVarh
82	CH1_EqC-	float	2	Channel_1 C phase negative reactive energy, Unit: kWh
100-182	CH2_	float	2	Channel_2 parameter, structure refer to Channel_1
200-282	CH3_parameter	float	2	Channel_3 parameter, structure refer to Channel_1
300-382	CH4_parameter	float	2	Channel_4 parameter, structure refer to Channel_1

### 5.3.2- Meter status data

Address	Data	Byte mode		Instruction
1202	Alarm	int	1	0: without alarm 1: Alarm triggered Bit 0~4 show Alarm_1~5 status
1240	Wiring mode	Int	1	0: 3P4W 1: 3P3W-2CT 2: 3P3W-3CT
1241	Voltage range	Int	1	Unit: V
1242	Current range	Int	1	Unit: mA
1243	PT ratio	Int	1	Range: 1-9999
1244	CT of CH1	Int	1	Range: 1-9999
1245	CT of CH2	Int	1	Range: 1-9999
1246	CT of CH3	Int	1	Range: 1-9999
1247	CT of CH4	Int	1	Range: 1-9999

### 5.3.3 - Voltage harmonic (max 21th)

Address	Data	Byte mode		Instruction
1300	THDUa	int	1	A-phase Voltage THD, unit 0.1%
1301	THDUb	int	1	B-phase Voltage THD
1302	THDUc	int	1	C-phase Voltage THD
1303	TOHDUa	int	1	A-phase Voltage odd harmonic total distortion, unit 0.1%
1304	TOHDUb	int	1	B-phase Voltage odd harmonic total distortion

1305	TOHDUc	int	1	C-phase Voltage odd harmonic total distortion
1306	TEHDUa	int	1	A-phase Voltage even harmonic total distortion, unit 0.1%
1307	TEHDUb	int	1	B-phase Voltage even harmonic total distortion
1308	TEHDUc	int	1	C-phase Voltage even harmonic total distortion
1320-1339	HUa	int	20	A phase voltage harmonic ratio for 2 to 21th, unit 0.1%
1340-1359	HUb	int	20	B phase voltage harmonic ratio for 2 to 21th
1360-1379	HUc	int	20	C phase voltage harmonic ratio for 2 to 21th

### 5.3.4 - Current harmonic (max 21th)

Address	Data	Byte mode		Instruction
1400	THDIa1	int	1	Channel_1 A-phase Current THD, unit 0.1%
1401	THDIb1	int	1	Channel_1 B-phase Current THD
1402	THDIc1	int	1	Channel_1 C-phase Current THD
1403	TOHDla1	int	1	Channel_1 A-phase Current odd harmonic total distortion, unit 0.1%
1404	TOHDlb1	int	1	Channel_1 B-phase Current odd harmonic total distortion
1405	TOHDlc1	int	1	Channel_1 C-phase Current odd harmonic total distortion
1406	TEHDla1	int	1	Channel_1 A-phase Current even harmonic total distortion, unit 0.1%
1407	TEHDlb1	int	1	Channel_1 B-phase Current even harmonic total distortion
1408	TEHDlc1	int	1	Channel_1 C-phase Current even harmonic total distortion
1420-1439	HIa1	int	20	Channel_1 A phase Current harmonic ratio for 2 to 21th, unit 0.1%
1440-1459	HIb1	int	20	Channel_1 B phase Current harmonic ratio for 2 to 21th
1460-1479	HIc1	int	20	Channel_1 C phase Current harmonic ratio for 2 to 21th
1500-1579	CH2 Harmonic	int	20	Channel_2 harmonic value, structure refer to Channel_1
1600-1679	CH3 Harmonic	int	20	Channel_3 harmonic value, structure refer to Channel_1
1700-1779	CH4 Harmonic	int	20	Channel_4 harmonic value, structure refer to Channel_1

## 6. - SAFETY CONSIDERATIONS



All installation specification described at the previous chapters named:  
**INSTALLATION AND STARTUP, INSTALLATION MODES and SPECIFICATIONS.**

Note that with the instrument powered on, the terminals could be dangerous to touching and cover opening actions or elements removal may allow accessing dangerous parts. This instrument is factory-shipped at proper operation condition.

## 7. - MAINTENANCE

The MCM400 does not require any special maintenance. No adjustment, maintenance or repairing action should be done when the instrument open and powered on, should those actions are essential, high-qualified operators must perform them.

Before any adjustment, replacement, maintenance or repairing operation is carried out; the instrument must be disconnected from any power supply source.

When any protection failure is suspected to exist, the instrument must be immediately put out of service. The instrument's design allows a quick replacement in case of any failure.

## 8. - TECHNICAL SERVICE

For any inquiry about the instrument performance or any failure  
Contact to Blue Jay's technical service.

*Blue Jay - After-sales service*

*E-mail : [tech@cqbluejay.com](mailto:tech@cqbluejay.com)*