

# ALM-CH6 Fault Annunciator

## User Manual



**Version: 1.10**

**Revision: 2025.11**

## Read me

**When you use ALM-CH6 Fault annunciator, be sure to read this user manual carefully, and be able to fully understand the implications, the correct guidance of operations in accordance with user manual, which will help you make better use of ALM-CH6 Fault annunciator, and help to solve the various problems at the scene.**

1. Before the meter turning on the power supply, be sure that the power supply within the provisions of the instrument;
2. When installation, the current input terminal must non-open, voltage input terminals must Non-short circuit;
3. Communication terminal (RS232/RS485) is strictly prohibited to impose on high pressure;
4. Be sure the instrument wiring consistent with the internal system settings;
5. When communicating with the PC, instrument communication parameters must be consistent with the PC.



- **Please read this user manual carefully**
- **Please save this document**

## Directory

<b>1.- SUMMARIZE .....</b>	<b>- 3 -</b>
<b>2.- TECHNICAL PARAMETERS .....</b>	<b>- 4 -</b>
<b>3.- FUNCTION DESCRIPTION .....</b>	<b>- 5 -</b>
<b>4.- INSTALLATION AND START-UP .....</b>	<b>- 6 -</b>
4.1.- INSTALLATION .....	- 6 -
4.2.- FRONT PANEL INDICATORS AND CONTROLS .....	- 7 -
4.3.- CONNECTION TERMINAL .....	- 8 -
<b>5.- COMMUNICATION INTERFACE .....</b>	<b>- 10 -</b>
5.1.- MEASUREMENT DATA, READ ONLY, FUNCTION 0x03 TO READ .....	- 10 -
5.2.- READABLE AND WRITABLE REGISTER (FUNCTION 0x03 TO READ, 0x06 TO WRITE) .....	- 10 -
<b>6.- SAFETY CONSIDERATIONS .....</b>	<b>- 11 -</b>
<b>7.- MAINTENANCE .....</b>	<b>- 11 -</b>

## 1.- SUMMARIZE

ALM-CH6 fault annunciator are installed on the cabinet panel. They are simple, compact and can improve wiring efficiency. They are universal alarms suitable for power control and monitoring systems. The alarm uses a highly reliable MCU to monitor external status in real time. When an abnormality occurs, the corresponding indicator light on the panel lights up, the buzzer sounds an alarm, and the alarm relay responds quickly.

The alarm can be muted, reset, tested, etc. by pressing buttons. The product supports RS485/MODBUS-RTU communication protocol.

### FEATURES

- High brightness LED display;
- 96\*96mm panel mounting;
- Flashing alarm lights remain until confirmed;
- Customized or replaceable alarm labels;
- Reliable passive relay contact outputs;
- Centralized alarm output for multiple signals;
- Self-fault alarm with normally closed contact;
- Sound alarm interface supports external devices;
- Modular design for easy installation and maintenance.

### APPLICATIONS

- Power generation and distribution systems;
- Industrial manufacturing and production facilities;
- Oil, gas, and petrochemical processing plants;
- Data centers and server farm operations;
- Railway, aviation, and maritime transportation systems;
- Heating, ventilation, and air conditioning (HVAC) systems.

## 2.- TECHNICAL PARAMETERS

Parameter	Value
Operating voltage	85-265VAC/DC ( $\pm 10\sim 15\%$ ), optional 24VDC
Rated power	$\leq 8W$
Fault signal inputs	6 channels, Active dry contact with 15Vdc feed, no need extra power supply.
Response time	$\leq 100ms$
Flashing frequency	$> 1Hz$
Relay outputs	3 channels for Load capacity: 5A@250VAC, 0.5A@110VDC, 0.3A@220VDC
Panel protection level	Front: IP54; Rear: IP20
Communication	RS485 Modbus RTU
Indication method	LED indicator or illuminated text panel
Insulation performance	2.5 kV AC RMS 1 minute, between input / output / case / power supply. 2 kV AC RMS 1 minute, between input / power supply/ communication.
Operating environment	Temperature: $-20^{\circ}C \sim +60^{\circ}C$ ; Humidity: Annual avg. $\leq 75\%$ , max $\leq 93\%$
Wiring terminal	0.2...2.5mm <sup>2</sup>
Working cycle	100%
Installation method	Panel mount
Dimension	Frame size 96x96 mm; hole size:91x91mm

### 3.- FUNCTION DESCRIPTION

- . When a valid alarm signal is collected, the corresponding alarm indicator light will light up and keep flashing, with a flashing frequency  $>1\text{Hz}$ , and it will remain until it is confirmed. After confirmation: if the fault signal still exists, the alarm indicator light will continue to light up and the flashing will disappear; if the fault signal disappears, the indicator light will be off.
  
- . The text description next to the alarm indicator light can be easily modified according to actual needs.
  
- . The DI/DO is all passive contacts.
  
- . Centralized alarm output: when any alarm signal input is on, the corresponding DO contact is closed, and when the alarm is confirmed, and all alarm signals disappear. The corresponding DO contact is disconnected. The centralized alarm output relay is located on the alarm host.
  
- . Annunciator self-fault alarm output: self-fault is defined as no power supply or annunciator main IC card failure. When a fault occurs, the normally closed contact is closed; when there is no fault, the normally closed contact is disconnected.
  
- . Sound alarm output, any alarm signal input, the sound alarm relay output contact is closed, and the sound alarm relay output contact is disconnected after confirmation. This sound alarm relay output contact can be used to connect an external alarm sound source device (such as an electric flute, buzzer, etc.). This relay is located on the alarm host.

## 4.- INSTALLATION AND START-UP



The manual you hold in your hand contains information and warnings that the user should respect in order to guarantee a proper operation of all the instrument functions and keep it in safety conditions. The instrument must not be powered on and used until its definitive assembly is on the cabinet's door.

**If the instrument is not used as manufacturer's specifications, the protection of the instrument will be damaged.**

When any protection failure is suspected to exist (for example, it presents external visible damages), the instrument must be immediately powered off. In this case contact a qualified service representative.

### 4.1.- Installation

#### Panel mounting

Instrument is to be mounted on panel (cut-out  $91+0.8 \times 91+0.8 \text{ mm}$ ). Keep all connections into the cabinet.

Please note that as the instrument be powered on, the terminals could be dangerous to touch and cover opening actions or elements removal may allow accessing dangerous parts. Therefore, the instrument must not be used until this is completely installed.

**Dimension: Unit: mm**

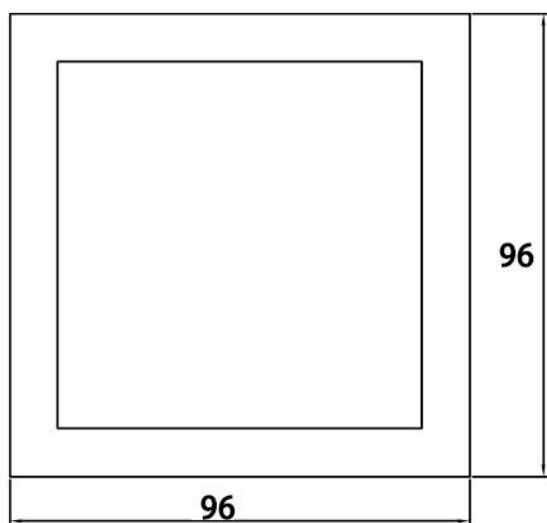



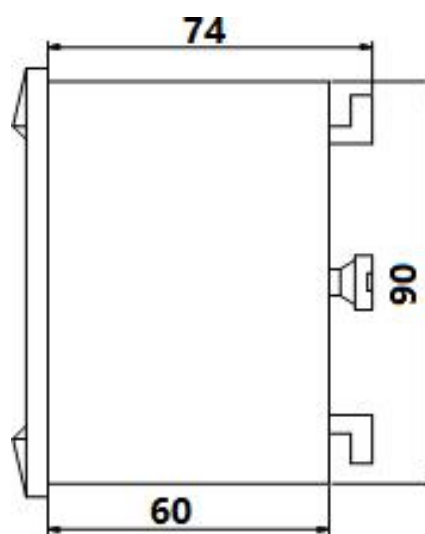



**Front view**

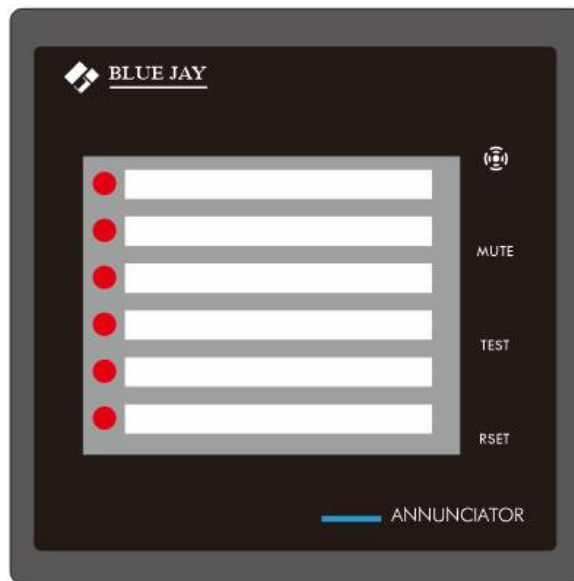

**Side view**

## 4.2.- Front Panel Indicators and Controls



	Fault LEDs, Indicates fault signals of channels 1–6
	Customized fault information label, inserted via the left-side slot
	Buzzer, sounds an alarm when a new fault occurs; can be muted via the “MUTE” button
	Buzzer muted, resets the buzzer output
	Fault LED Indicator test, press to check all fault LEDs. If an LED fails to light, it indicates an error
	Reset the alarm relay output

### Note:

Simultaneously Press and hold “MUTE, TEST, and RSET” for more than 3 seconds to restore communication settings to the default value.

### 4.3.- Connection Terminal

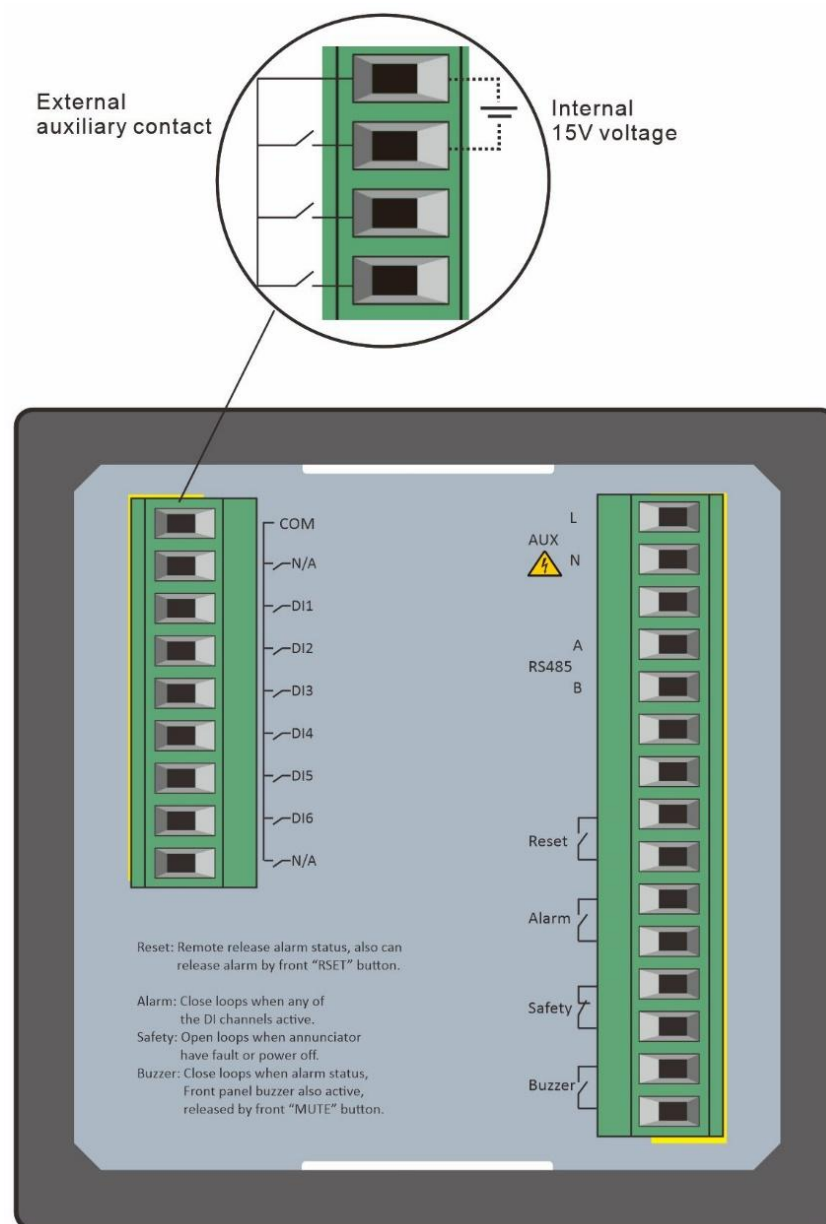

Marked	Notes
<b>COM</b>	Input signal common terminal (positive pole)
<b>N/A</b>	Reserved function, not available
<b>DI 1-6</b>	Corresponding to channel 1~6 fault signal inputs, Active dry contact with 15Vdc feed, support external auxiliary contact / DO input, no external power required.
<b>AUX L, N</b>	Power supply 85-265Vac/dc
<b>RS485 A, B</b>	RS485+/-, communication

<b>Reset</b>	Remote release alarm status, also can release alarm by front “RSET” button.
<b>Alarm</b>	Close loops when any of the DI channels active.
<b>Safety</b>	Open loops when annunciator has fault or power off.
<b>Buzzer</b>	Close loops when alarm status, Front panel buzzer also active, released by front “MUTE” button.

**Note:**

The terminal pin definition may change depends on customer order; please refer to the label on the device.

## 5.- COMMUNICATION INTERFACE

### 5.1.- Measurement data, read only, function 0x03 to read

Register	Data	Byte mode		Instruction
0000	DI 1-6	int	1	Channel 1-6 DI status
0002	ALM 1-6	int	1	Channel 1-6 alarm status
0004	RST 1-6	int	1	Channel 1-6 status after reset
0006	DO 1-3	int	1	Channel 1-3 relay output status

Note: In 6-channel version, only bits 1–6 of the above [0000-0004] register are used, other bits are reserved, details see following:

Bit 0: reserved	Bit 3: channel 3	Bit 6: channel 6
Bit 1: channel 1	Bit 4: channel 4	Bit 7-15: reserved
Bit 2: channel 2	Bit 5: channel 5	

### 5.2.- Readable and writable register (function 0x03 to read, 0x06 to write)

Register	Data	Byte mode		Instruction
0020	Communication address	int	1	Range: 1-247
0021	Communication baud rate	int	1	0: 2400, 1: 4800, 2: 9600, 3: 19200
0022	Communication data format	int	1	0: n.8.1, 1: o.8.1, 2: e.8.1, 3: n.8.2

#### Note:

Simultaneously press and hold the front panel function button “**MUTE, TEST, REST**” for more than 3 seconds to restore communication settings to the default value.

## 6.- SAFETY CONSIDERATIONS



All installation specification described at the previous chapters named: **INSTALLATION AND STARTUP, INSTALLATION MODES and SPECIFICATIONS.**

Please note that with the instrument powered on, the terminals could be dangerous to touching and cover opening actions or elements removal may allow accessing dangerous parts. This instrument is factory-shipped at proper operation condition.

- ◆ The device must have a professional installation and maintenance
- ◆ Any operation of the device, you must cut off the input signal and power;

## 7.- MAINTENANCE

The ALM-CH6 does not require any special maintenance. No adjustment, maintenance or repairing action should be done when the instrument is open and powered on, should those actions are essential, high-qualified operators must perform them.

Before any adjustment, replacement, maintenance or repairing operation is carried out, the instrument must be disconnected from any power supply source.

When any protection failure is suspected to exist, the instrument must be immediately put out of service. The instrument's design allows a quick replacement in case of any failure.

For any inquiry about the instrument performance or any failure, contact to Blue Jay's technical service.

*Blue Jay - After-sales service*

E-mail: [tech@cqbluejay.com](mailto:tech@cqbluejay.com)